

Profilor

BODENBELAG



Schienen und Profile

Farbübersicht Profile und Einlagen

Aluminium farbig eloxiert

aluminium anodized



Messing /Edelstahl

brass/stainless steel

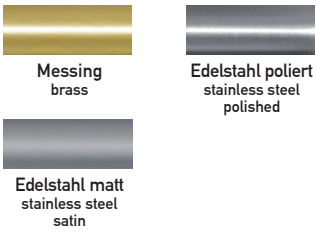

Aluminium abriebfest emailiert

aluminium hard wearing enameled



Kunststoffoberfläche in Holzdekor









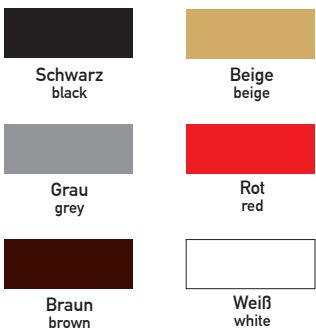







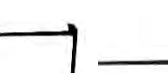

plastic surface wood decor





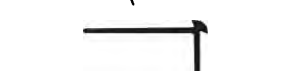

farbiger Kunststoff





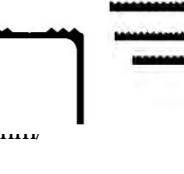
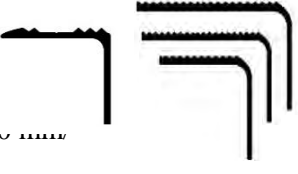

coloured PVC

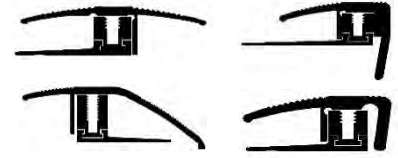

| Seite/ page | | Form/ shape | Koffer-Nr./ case no. |
|---|--|---|-------------------------|
| 1. Winkelprofile und Treppenkanten aus Aluminium und Messing | | | |
| 1. angle edges and stair nosings out of aluminium + brass | | | |
| 2-3 | Winkelprofil 10x24,5 mm angle edge 10x24,5 mm |  | 89 |
| 4-5 | Winkelprofil 18x24,5 mm angle edge 18x24,5 mm |  | 88 |
| 6 | Treppenkante 20x20/ 30x30 mm stair nosing 20x20/ 30x30 mm |  | 85/90/99/100 |
| 7 | Treppenkante 30x30x2 mm R/ 22x30/ 27x27/ 32x30 mm stair nosing 30x30x2 mm R/ 22x30/ 27x27/ 32x30 mm |  | 342/343/372/388 |
| 8 | Treppenkante 42x30/ 42x40/ 52x30 mm stair nosing 42x30/ 42x40/ 52x30 mm |  | 344/345/389 |
| 9 | Treppenkante 15x40/ 23x40 mm stair nosing 15x40/ 23x40 mm |  | 87/95 |
| 10 | Treppenkante 20x40 mm + Spezialemailierung + Nachleuchtend stair nosing 20x40 mm + hard wearing enamel + photoluminescent |  | 91/97 |
| 11 | Treppenkante 28x50/ 42x50 mm stair nosing 28x50/ 42x50 mm |  | 83/84 |
| 12 | Treppenkante 55x69 mm/ Vorstoßprofil 2x25/ 3x30/ 3x35 mm stair nosing 55x69 mm/ edge profile 2x25/ 3x30/ 3x35 mm |  | 127-129/339 |
| 13 | Fassonprofil 2 / 2,5 / 3 mm fashion stair nosing 2 / 2,5 / 3 mm |  | 474-476 |
| 14 | Treppenkante 10x37x2/ 24x37x2/ 40x37x2/ 10x37x2,5 stair nosing 10x37x2/ 24x37x2/ 40x37x2/ 10x37x2,5 |  | 266/383/435/436 |
| 15 | Treppenkante 24x37x2,5/ 40x37x2,5/ 10x37x3/ 24x37x3 mm stair nosing 24x37x2,5/ 40x37x2,5/ 10x37x3/ 24x37x3 mm |  | 94/384/385/437 |
| 16 | Treppenkante 40x40x3/ 10x37x5/ 24x37x5/ 40x40x5 mm stair nosing 40x40x3/ 10x37x5/ 24x37x5/ 40x40x5 mm |  | 267/334/340/341 |
| 17 | Treppenkante 10x37x7 mm/ wendbares Treppenseitenprofil 3/ 5 mm stair nosing 10x37x7 mm/ turnable stair side profile 3 / 5 m |  | 333/496 |
| 18 | ALU-Treppeninnenecken 3 + 5 mm stair inside corner 3 + 5 mm |  | 369/370 |
| 19 | Messing-Treppenkante 10x30x1,2/ 20x40x1,5/ 40x40x1,5/ 15x35 mm brass stair nosing 10x30x1,2/ 20x40x1,5/ 40x40x1,5/ 15x35 mm |  | 98/205/270/271 |
| 20 | Kombi-Treppenkante 27x40/ 27x58/ 45x58 mm combination stair nosing 27x40/ 27x58/ 45x58 mm |  | 81/82/147 |
| 21 | Kombi-Winkel 80x58 mm + Einlagen 27 mm/ Treppenkante 15x36 mm + Einlagen 12 mm combination stair nosing 80x58 mm + insert 27 mm/ stair nosing 15x36 mm + insert 12 mm |  | 92/121/146/ 485/486 |
| 22 | Treppenkante 39x48/ 43x50 mm + Einlagen 39 mm stair nosing 39x48/ 43x50 mm + insert 39 mm |  | 373-375/390/487 |
| 23 | Treppenkante 28,5x53/ 28,5x75 mm + Einlagen 23 mm stair nosing 28,5x53/ 28,5x75 mm + insert 23 mm |  | 80/86/488-490 |
| 24 | Treppenkante 30x40x2/ 30x40x2,5/ 30x40x3/ 30x40x5 mm stair nosing 30x40x2/ 30x40x2,5/ 30x40x3/ 30x40x5 mm | | 134/135/264/386 |
| 25 | Treppenkante Doppeleinschub 3 / 5 mm double insert stair nosing 3 / 5 mm | | 491/492 |

| Seite/ page | | Form/ shape | Koffer-Nr./ case no. |
|---|---|---|-------------------------------------|
| 2. Treppenkanten aus Edelstahl | | | |
| 2. stair nosings out of stainless steel | | | |
| 27 | Edelstahl-Treppenkante 1,5 mm INOX PROTECT 25x63/ 35x63/ 45x63 mm + Trenn- & Faecherscheibe stainless steel stair nosing 1,5 mm INOX PROTECT 25x63/ 35x63/ 45x63 cutting disc + flap disc |  | 394-396 |
| 28 | Edelstahl-Einschubprofil mit Nase stainless steel nosed insert profile |  | 228/229/252-254/ 352-355/399-405 |
| 29 | Edelstahl-Treppeninnenecke 3 + 5 mm stainless steel stair inside corner 3 + 5 mm |  | 367/368/406-411 |
| 30 | Edelstahl-Treppenkante 1,5 mm profilierte Riffelung 20x40/ 40x40/ 30x30/ 20x30/ 10x30 mm stainless steel stair nosing 1,5 mm fluted profile 20x40/ 40x40/ 30x30/ 20x30/ 10x30 mm |  | 154/201-204 |
| 31 | Edelstahl-Treppenkante 3,0 mm gefraeste Riffelung 20x40/ 30x30/ 28x50 mm/ Treppenkante Edelstahl V4A gezogen 23x25x3,5 mm stainless steel stair nosing 3,0 mm antislip fluting 20x40/ 30x30/ 28x50 mm drawn stainless steel stair nosing V4A 23x25x3,5 mm |  | 206-208/438 |
| 32 | Edelstahl-Treppenkante 1,5 mm mit Praegelochung 10x30/ 20x40/ 25x60/ 25x80 / 50x80 mm stainless steel stair nosing 1,5 mm with embossed punching 10x30/ 20x40/ 25x60/ 25x80 / 50x80 mm |  | 311/312/318-320 |
| 33 | Edelstahl-Treppenkante 1,5 mm mit Praegelochung u. Anker 10x30/ 20x40/ 25x60/ 25x80 / 50x80 mm stainless steel stair nosing 1,5 mm with embossed punching + anchor 10x30/ 20x40/ 25x60/ 25x80 / 50x80 mm |  | 328-332 |

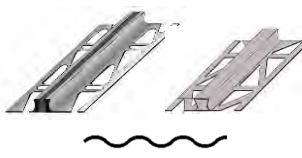
| Seite/ page | | Form/ shape | Koffer-Nr./ case no. |
|---|---|----------------|--|
| 4. Uebergangprofile aus Aluminium, Edelstahl und Messing | | | |
| 4. connecting profiles out of aluminium + stainless steel + brass | | | |
| 44-47 | Uebergangsprofil 20/ 28 mm connecting profile 20/ 28 mm | | 01/05/13/14/ 142-144 |
| 48 | Uebergangsprofil 24/ 27x1,7 mm connecting profile 24/ 27x1,7 mm | | 10/11 |
| 49 | StegUebergangsprofil 28x4,5 mm connecting profile with bars 28x4,5 mm | | 06 |
| 50-51 | Uebergangsprofil 37x4,5 mm connecting profile 37x4,5 mm | | 02/07/15/16 |
| 52 | Uebergangsprofil 38x1,8 mm connecting profile 38x1,8 mm | | 12 |
| 53 | Uebergangsprofil 48/ 50 mm connecting profile 48/ 50 mm | | 03/145/155 |
| 54 | Uebergangsprofil 57/ 58 mm connecting profile 57/ 58 mm | | 04/08 |
| 55 | Uebergangsprofil 80 mm connecting profile 80 mm | | 350 |
| 56 | Edelstahl-Ueberg. 27/ 38 mm profilierte Riffelung/ Uebergang 30x3,5 mm Edelstahl V4A gezogen/ Edelstahl-Uebergangsprofil 70x1,5 mm INOX PROTECT stainless steel connecting profile 27/ 38 mm fluted profile/ connecting profile 30x3,5 mm drawn stainless steel V4A/ stainless steel connecting profile 70x1,5 mm INOX PROTECT | | 412/439-441 |
| 57 | Edelstahl-Uebergangspr. 50/ 60/ 80/ 100x1,5/ 2,0/ 3,0 mm, gekantet stainless steel connecting profile 50/ 60/ 80/ 100 x 1,5/ 2,0/ 3,0 mm, edged | | 136/237-240/250 |
| 58 | Edelstahl-Flachprofil 40/ 50/ 60/ 70/ 80/ 100x1,0/ 1,5/ 2,0/ 3,0 mm stainless steel flat profile 40/ 50/ 60/ 70/ 80/ 100x1,0/ 1,5/ 2,0/ 3,0 mm | | 285-291/413-426/ 442-445 |
| 59 | Abschlussprofil 30x4,5 mm/ Anpassungsprofil 40 mm fUer Ausgleich 2-16 mm adaptation profile 30x4,5 mm, levelling profile 40 mm for height compensation 2-16 mm | | 09/349 |
| 60 | Abschlussprofil fUer Laminat 34x8,5/ Parkett 47x15,5 mm adaptation profile 34x8,5 mm/ 47x15,5 mm | | 132/133 |
| 61 | Sockelprofil 8x18,4 mm plinth profile 8x18,4 mm | | 137 |
| 5. Einschub- und Anstoßprofile aus Aluminium | | | |
| 5. insert profiles out of aluminium | | | |
| 63 | Doppeleinschubprofil 14x3/ 14x5/ 14x7 mm Laminat-Uebergang 1-teilig/ -Höhenausgleich, 1-teilig double insert profile 14x3/ 14x5/ 14x7 mm/ laminate-edge/ height levelling, single piece | | 130/131/346-348 |
| 64 | Doppel-/ Einfach-/ Miniklemmprofil double-/ single-/ mini clamping profile | | 19/20/23 |
| 65 | Einfassschiene 2/ 2,5/ 3/ 5 mm insert profile 2/ 2,5/ 3/ 5 mm | | 22/268/269/387 |
| 66 | Anstoßprofil 3; 5/3 ; 3/3 ; 5/5 mm insert profile 3; 5/3 ; 3/3 ; 5/5 mm | | 27-30 |
| 67 | Rampenanstoßprofile 2/ 3/ 5/ 8 mm ramp profile 2/ 3/ 5/ 8 mm | | 282-284/480 |
| 68-70 | Einschubprofil h = 3/ 5/ 6/ 7/ 8,5/ 10/ 13/ 15 mm insert profile h = 3/ 5/ 6/ 7/ 8,5/ 10/ 13/ 15 mm | | 18/24/108-111/ 258/446 |
| 71-73 | Einschubprofil mit Nase h = 3/ 5/ 8,5/ 10/ 13/ 15 mm nosed insert profile h = 3/ 5/ 8,5/ 10/ 13/ 15 mm | | 17/21/93/105/ 112/262/263/ 265/427/478 |
| 74 | Treppenkante 20x33 h= 8,5/ 10/ 13/ 15 mm stair nosing 20x33 h= 8,5/ 10/ 13/ 15 mm | | 101/259-261 |

| Seite/ page | | Form/ shape | Koffer-Nr./ case no. |
|---|--|---|---|
| 7. Systemprofile aus Aluminium und Edelstahl fUer 4 - 24 mm Belaege | | | |
| 7. system profiles out of aluminium + stainless steel for 4 - 24 mm floorings | | | |
| 79-82 | MINI-APL-System 5-9 mm/ APL-System 7-15 mm, 2-teilig MINI-APL-system 5-9 mm/ APL-system 7-15 mm, 2 parts |  | 255-257/306-308/ 497-499 |
| 83-88 | MINI-APL-Klick-System 4-7mm, 2-teilig/ APL-Klick-System 7-10 / 11-15/ 15-24 mm, 2-teilig MINI-APL-click-system 4-7mm/ APL-click-system 7-10 / 11-15/ 15-24 mm, 2 parts |  | 272-277/ 447-451 |
| 89-90 | SKD-Profilsystem fUer Klickdesign-Belaege 4-7 mm, flexibel, 2-teilig SKD-system for click design flooring 4-7 mm, flexibel, 2 parts |  | 315-317/ 327/351 |
| 91-93 | SLP-System 7-17 mm & 12-22 mm, flexibel, 3-teilig/ SLP-Treppenkante 7-15,5 mm, flex., 3-teilig/ SLP-System 7-17 mm, Edelstahl, flex., 3-teilig SLP-system 7-17 mm + 12-22 mm/ SLP-stair nosing 7-15,5 mm/ SLP-system 7-17 mm, stainless steel, flexible, 3 parts |  | 138-141/ 148-153/164 |
| 9. Fliesentrenn-, Dehnungsfugen-, Bau- & T-Profile aus Aluminium, Edelstahl, Messing & PVC | | | |
| 9. ceramic tile separation profiles + expansion gap profiles out of aluminium + stainless steel + brass + PVC | | | |
| 110-111 | Fliesentrennprofil Aluminium/ Messing/ Edelstahl/ PVC ceramic tile separation profile aluminium/ brass/ stainless steel/ PVC |  | 32-34/36 |
| 112 | Flexibles Fliesentrennprofil Aluminium/ Messing/ Edelstahl flexible ceramic tile separation profile aluminium/ brass/ stainless steel |  | 35/165/166 |
| 113-115 | Dehnungsfugenprofil Aluminium/ Messing/ Edelstahl/ PVC/ Wellenverbinder/ Dehnungsfugenprofil mit Glitter-Einlage expansion gap profile aluminium/ brass/ stainless steel/ PVC/ wave connector/ expansion gap profile with glitter insert |  | 31/167/168/ 169/281 |
| 120 | Eloxal-Winkel/ T-Profil 14/ 25 mm/ T-Profil-DUEbel anodized angle/ T-profile 14/ 25 mm/ T-profile dowel |  | 25/26/178/ 179/483 |
| 131 | Edelstahl-Reparaturwinkel B20 / verzinkte Stahl-Reparaturwinkel H15 / H20 / H38 / B15 / B20 /Rund-Reparaturwinkel B25 x 40 R 7,5 f. Debolon-TK 3, Stahl-verzinkt stainless steel repair angle B20 / galvanized steel repair angle H15 / H20 / H38 / B15 / B20 / round repair angle B25 x 40 R 7,5, galvanized steel |  | 119 / 120 / 242 - 244 / 336 / 432 |

1. WINKELPROFILE + TREPPENKANTEN AUS ALUMINIUM UND MESSING

1. ANGLE EDGES + STAIR NOSINGS
OUT OF ALUMINIUM AND BRASS



1. WINKELPROFILE + TREPPENKANTEN AUS ALUMINIUM + MESSING / 1. ANGLE EDGES + STAIR NOSINGS ALU + BRASS

Andere Eloxalfarben siehe Abschnitt 6,
Lieferzeit 14 Tage/ other anodized colours
see section 6, delivery time 14 days

89 Winkelprofil 10 x 24,5 mm, Aluminium eloxiert, selbstklebend
angle edge 10 x 24,5 mm,
aluminium anodized,
self adhesive



| Profi-Pack à 10 StUeck im Bund | | | |
|--|---------------------|-------------------------|-----------------------|
| professional packing à 10 pcs. | | | |
| Farbe/colour | L / l (m) | Art./ref. | €/Stk./pcs. |
| 89 Winkelprofil 10 x 24,5 mm, Aluminium eloxiert, selbstklebend | | | |
| silver | 1,0 | 4503-8 | 5,52 |
| silver | 2,7 | 4533-5 | 14,90 |
| goldfarbig, gold | 1,0 | 4603-5 | 6,70 |
| goldfarbig, gold | 2,7 | 4633-2 | 18,06 |
| bronzef. Hell,bronze light | 1,0 | 4703-2 | 7,00 |
| bronzef. hell bronze light | 2,7 | 4733-9 | 18,92 |
| bronzef. dunkel bronze dark | 1,0 | 4803-9 | 7,00 |
| bronzef. dunkel bronze dark | 2,7 | 4833-6 | 18,92 |
| gold hell gold light | 1,0 | 70622-9 | 6,70 |
| gold hell gold light | 2,7 | 70624-3 | 18,06 |
| edelstahlfarbig | 1,0 | 70626-7 | 7,00 |
| edelstahlfarbig | 2,7 | 70628-1 | 18,92 |

| SB-Pack incl. Schr./ DUebel; VE 20 Stk. | |
|---|-------------|
| self-service-pack with screws/ dowels; à 20 pcs. | |
| Art./ref. | €/Stk./pcs. |

| | |
|-------------------------|-----------------------|
| 4502-1 | 6,28 |
| 4532-8 | 16,96 |
| 4602-8 | 7,54 |
| 4632-5 | 20,28 |
| 4702-5 | 7,82 |
| 4732-2 | 21,12 |
| 4802-2 | 7,82 |
| 4832-9 | 21,12 |
| 70630-4 | 7,54 |
| 70632-8 | 20,28 |
| 70634-2 | 7,82 |
| 70636-6 | 21,1 |

| | | | | |
|----------------------------|----------------------------|---------------------|-------------------------|-----------------------|
| Holzdekorfolie/ wood decor | Buche, beech | 1,0 | 38640-7 | 11,76 |
| | Buche, beech | 2,7 | 38650-6 | 31,72 |
| | Eiche, oak | 1,0 | 38660-5 | 11,76 |
| | Eiche, oak | 2,7 | 38670-4 | 31,72 |
| | Ahorn, maple | 1,0 | 38680-3 | 11,76 |
| | Ahorn, maple | 2,7 | 38690-2 | 31,72 |
| | Kirschbaum, cherry wood | 1,0 | 38780-0 | 11,76 |
| | Kirschbaum, cherry wood | 2,7 | 38785-5 | 31,72 |
| | Eiche rustikal, rustic oak | 1,0 | 38790-9 | 11,76 |
| | Eiche rustikal, rustic oak | 2,7 | 38795-4 | 31,72 |

| | |
|-------------------------|-----------------------|
| 38641-4 | 12,24 |
| 38651-3 | 33,16 |
| 38661-2 | 12,24 |
| 38671-1 | 33,16 |
| 38681-0 | 12,24 |
| 38691-9 | 33,16 |
| 38781-7 | 12,24 |
| 38786-2 | 33,16 |
| 38791-6 | 12,24 |
| 38796-1 | 33,16 |

1. WINKELPROFILE + TREPPENKANTEN AUS ALUMINIUM + MESSING / 1. ANGLE EDGES + STAIR NOSINGS ALU + BRASS

Andere Eloxalfarben siehe Abschnitt 6,
 Lieferzeit 14 Tage/ other anodized
 8 8 see section 6, delivery time
 14 days

Winkelprofil 18 x 24,5 mm, Aluminium eloxiert, gebohrt

angle edge 18 x 24,5 mm,
 aluminium anodized, drilled



| Profi-Pack à 10 StUeck im Bund | | | |
|--------------------------------|-----------|-----------|-------------|
| professional packing à 10 pcs. | | | |
| Farbe/colour | L / l (m) | Art./ref. | €/Stk./pcs. |

| | | | |
|-------------------------------------|---------------------|-------------------------|-----------------------|
| silver coloured | 0,8 | 4080-4 | 3,72 |
| silver coloured | 0,9 | 4090-3 | 4,20 |
| silver coloured | 1,0 | 4100-9 | 4,66 |
| silver coloured | 1,2 | 4110-8 | 5,60 |
| silver coloured | 2,0 | 4120-7 | 9,32 |
| silver coloured | 2,7 | 4130-6 | 12,58 |
| gold coloured | 0,8 | 4180-1 | 5,08 |
| gold coloured | 0,9 | 4190-0 | 5,74 |
| gold coloured | 1,0 | 4200-6 | 6,36 |
| gold coloured | 1,2 | 4210-5 | 7,64 |
| gold coloured | 2,0 | 4220-4 | 12,74 |
| gold coloured | 2,7 | 4230-3 | 17,18 |
| bronze light coloured | 0,8 | 4280-8 | 5,40 |
| bronze light coloured | 0,9 | 4290-7 | 6,08 |
| bronze light coloured | 1,0 | 4300-3 | 6,72 |
| bronze light coloured | 1,2 | 4310-2 | 8,08 |
| bronze light coloured | 2,0 | 4320-1 | 13,46 |
| bronze light coloured | 2,7 | 4330-0 | 18,22 |
| bronze dark coloured | 0,8 | 4380-5 | 5,40 |
| bronze dark coloured | 0,9 | 4390-4 | 6,08 |
| bronze dark coloured | 1,0 | 4400-0 | 6,72 |
| bronze dark coloured | 1,2 | 4410-9 | 8,08 |
| bronze dark coloured | 2,0 | 4420-8 | 13,46 |
| bronze dark coloured | 2,7 | 4430-7 | 18,22 |
| gold light coloured | 0,8 | 70640-3 | 5,08 |
| gold light coloured | 0,9 | 70642-7 | 5,74 |
| gold light coloured | 1,0 | 70644-1 | 6,36 |
| gold light coloured | 1,2 | 70646-5 | 7,64 |
| gold light coloured | 2,0 | 70648-9 | 12,74 |
| gold light coloured | 2,7 | 70650-2 | 17,18 |
| fine-honed stainless steel coloured | 0,8 | 70652-6 | 5,40 |
| fine-honed stainless steel coloured | 0,9 | 70654-0 | 6,08 |
| fine-honed stainless steel coloured | 1,0 | 70656-4 | 6,72 |
| fine-honed stainless steel coloured | 1,2 | 70658-8 | 8,08 |
| fine-honed stainless steel coloured | 2,0 | 70660-1 | 13,46 |
| fine-honed stainless steel coloured | 2,7 | 70662-5 | 18,22 |

| SB-Pack incl. Schr./ DUebel; VE 20 Stk. | |
|---|-------------|
| self-service-pack with screws/ dowels; à 20 pcs. | |
| Art./ref. | €/Stk./pcs. |

| | |
|-------------------------|-----------------------|
| 4091-0 | 4,94 |
| 4101-6 | 5,40 |
| 4121-4 | 10,80 |
| 4131-3 | 14,80 |
| 4191-7 | 6,54 |
| 4201-3 | 7,18 |
| 4221-1 | 19,18 |
| 4231-0 | 19,62 |
| 4291-4 | 6,98 |
| 4301-0 | 7,64 |
| 4321-8 | 15,30 |
| 4331-7 | 20,98 |
| 4391-1 | 6,84 |
| 4401-7 | 7,54 |
| 4421-5 | 15,08 |
| 4431-4 | 20,62 |
| 70664-9 | 6,54 |
| 70666-3 | 7,18 |
| 70668-7 | 19,18 |
| 70670-0 | 19,62 |
| 70672-4 | 6,84 |
| 70674-8 | 7,54 |
| 70676-2 | 15,08 |
| 70678-6 | 20,62 |

| | | | |
|----------------------------|---------------------|-------------------------|-----------------------|
| Buche, beech | 1,0 | 38520-2 | 10,70 |
| Buche, beech | 2,7 | 38530-1 | 28,94 |
| Eiche, oak | 1,0 | 38540-0 | 10,70 |
| Eiche, oak | 2,7 | 38550-9 | 28,94 |
| Ahorn, maple | 1,0 | 38560-8 | 10,70 |
| Ahorn, maple | 2,7 | 38570-7 | 28,94 |
| Kirschbaum, cherry wood | 1,0 | 38580-6 | 10,70 |
| Kirschbaum, cherry wood | 2,7 | 38585-1 | 28,94 |
| Eiche rustikal ,rustic oak | 1,0 | 38590-5 | 10,70 |
| Eiche rustikal ,rustic oak | 2,7 | 38595-0 | 28,94 |

| | |
|-------------------------|-----------------------|
| 38521-9 | 11,54 |
| 38531-8 | 31,18 |
| 38541-7 | 11,54 |
| 38551-6 | 31,18 |
| 38561-5 | 11,54 |
| 38571-4 | 31,18 |
| 38581-3 | 11,54 |
| 38586-8 | 31,18 |
| 38591-2 | 11,54 |
| 38596-7 | 31,18 |

Holzdekorfolie/ wood decor

1. WINKELPROFILE + TREPPENKANTEN AUS ALUMINIUM + MESSING / 1. ANGLE EDGES + STAIR NOSINGS ALU + BRASS

Andere Eloxalfarben siehe Abschnitt 6,
Lieferzeit 14 Tage/ other anodized
see section 6, delivery time
14 days

88

Winkelprofil 18 x 24,5 mm, Alu. eloxiert, selbstkl.

angle edge 18 x 24,5 mm,
aluminium anodized,
self adhesive



| Profi-Pack à 10 StUeck im Bund | | | |
|--------------------------------|-----------|-----------|-------------|
| professional packing à 10 pcs. | | | |
| Farbe/colour | L / l (m) | Art./ref. | €/Stk./pcs. |

| SB-Pack incl. Schr./ DUebel; VE 20 Stk. | |
|---|-------------|
| self-service-pack with screws/ dowels; à 20 pcs. | |
| Art./ref. | €/Stk./pcs. |

| | | | |
|-----------------------------|---------------------|-------------------------|-----------------------|
| silver | 1,0 | 4103-0 | 6,04 |
| silver | 2,7 | 4133-7 | 16,30 |
| goldfarbig, gold | 1,0 | 4203-7 | 7,60 |
| goldfarbig, gold | 2,7 | 4233-4 | 20,54 |
| bronzef. Hell,bronze light | 1,0 | 4303-4 | 7,98 |
| bronzef. hell bronze light | 2,7 | 4333-1 | 21,46 |
| bronzef. dunkel bronze dark | 1,0 | 4403-1 | 7,98 |
| bronzef. dunkel bronze dark | 2,7 | 4433-8 | 21,46 |
| gold hell gold light | 1,0 | 70682-3 | 7,60 |
| gold hell gold light | 2,7 | 70684-7 | 20,54 |
| edelstahlfarbig | 1,0 | 70686-1 | 7,98 |
| edelstahlfarbig | 2,7 | 70688-5 | 21,46 |

| | |
|------------------------|-----------------------|
| 4102-3 | 6,80 |
| 4132-0 | 18,36 |
| 4202-0 | 8,40 |
| 4232-7 | 22,70 |
| 4302-7 | 8,76 |
| 4332-4 | 23,62 |
| 4402-4 | 8,76 |
| 4432-1 | 23,62 |
| 690-8 | 8,40 |
| 692-2 | 22,70 |
| 694-6 | 8,76 |
| 696-0 | 23,62 |

| | | | |
|----------------------------|---------------------|-------------------------|-----------------------|
| Buche, beech | 1,0 | 38460-1 | 12,88 |
| Buche, beech | 2,7 | 38470-0 | 34,82 |
| Eiche, oak | 1,0 | 38480-9 | 12,88 |
| Eiche, oak | 2,7 | 38490-8 | 34,82 |
| Ahorn,maple | 1,0 | 38500-4 | 12,88 |
| Ahorn,maple | 2,7 | 38510-3 | 34,82 |
| Kirschbaum,cherry wood | 1,0 | 38600-1 | 12,88 |
| Kirschbaum,cherry wood | 2,7 | 38605-6 | 34,82 |
| Eiche rustikal ,rustic oak | 1,0 | 38610-0 | 12,88 |
| Eiche rustikal ,rustic oak | 2,7 | 38615-5 | 34,82 |

| | |
|-------------------------|-----------------------|
| 38461-8 | 13,42 |
| 38471-7 | 36,28 |
| 38481-6 | 13,42 |
| 38491-5 | 36,28 |
| 38501-1 | 13,42 |
| 38511-0 | 36,28 |
| 38601-8 | 13,42 |
| 38606-3 | 36,28 |
| 38611-7 | 13,42 |
| 38616-2 | 36,28 |

Holzdekorfolie/ wood decor

1. WINKELPROFILE + TREPPENKANTEN AUS ALUMINIUM + MESSING / 1. ANGLE EDGES + STAIR NOSINGS ALU + BRASS

Andere Eloxalfarben siehe Abschnitt 6, Lieferzeit 14 Tage/
other anodized colours see section 6, delivery time 14 days

90 Treppenk. 20 x 20 mm, Aluminium eloxiert, gebohrt

stair nosing 20 x 20 mm, aluminium anodized, drilled

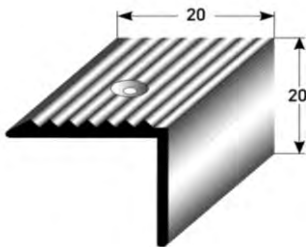

| Profi-Pack à 10 StUeck im Bund | | | |
|--------------------------------|-----------|-----------|-------------|
| professional packing à 10 pcs. | | | |
| Farbe/colour | L / l (m) | Art./ref. | €/Stk./pcs. |
| silver | 1,0 | 39500-3 | 5,76 |
| silver | 2,7 | 39510-2 | 15,56 |
| goldfarbig, gold | 1,0 | 39520-1 | 6,48 |
| goldfarbig, gold | 2,7 | 39530-0 | 17,54 |
| bronzef. Hell, bronze light | 1,0 | 39540-9 | 6,94 |
| bronzef. hell bronze light | 2,7 | 39550-8 | 18,76 |
| bronzef. dunkel bronze dark | 1,0 | 39560-7 | 6,94 |
| bronzef. dunkel bronze dark | 2,7 | 39570-6 | 18,76 |

| SB-Pack incl. Schr./DUebel; VE 20 Stk. | |
|---|-------------|
| self-service-pack with screws/dowels; à 20 pcs. | |
| Art./ref. | €/Stk./pcs. |
| 39501-0 | 6,56 |
| 39511-9 | 17,62 |
| 39521-8 | 7,30 |
| 39531-7 | 19,66 |
| 39541-6 | 8,16 |
| 39551-5 | 22,00 |
| 39561-4 | 7,74 |
| 39571-3 | 20,96 |

| | | | |
|--------------------------------|-----|---------|-------|
| MESSING poliert brass polished | 1,0 | 28733-9 | 22,90 |
| MESSING poliert brass polished | 2,5 | 28730-8 | 57,26 |

| | |
|---------|-------|
| 28732-2 | 23,88 |
| 28731-5 | 59,80 |

Bitte fordern Sie unsere Pflegehinweise für Messingprofile an!
Please ask for our care tips for brass profiles!

85 Treppenk. 30 x 30 mm, Aluminium eloxiert, gebohrt

stair nosing 30 x 30 mm, aluminium anodized, drilled

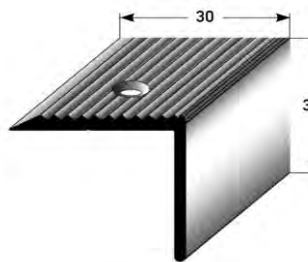

| | | | |
|-----------------------|-----|---------|-------|
| Silver colored | 0,9 | 31450-9 | 6,86 |
| Silver colored | 1,0 | 31455-4 | 7,62 |
| Silver colored | 2,7 | 31460-8 | 20,58 |
| gold coloured | 0,9 | 31465-3 | 9,18 |
| gold coloured | 1,0 | 31470-7 | 10,24 |
| gold coloured | 2,7 | 31475-2 | 27,58 |
| bronze light coloured | 0,9 | 31480-6 | 10,40 |
| bronze light coloured | 1,0 | 31485-1 | 11,54 |
| bronze light coloured | 2,7 | 31490-5 | 31,20 |
| bronze dark coloured | 0,9 | 31495-0 | 10,40 |
| bronze dark coloured | 1,0 | 31500-1 | 11,54 |
| bronze dark coloured | 2,7 | 31505-6 | 31,20 |

| | |
|---------|-------|
| 31456-1 | 8,40 |
| 31461-5 | 22,66 |
| 31471-4 | 11,06 |
| 31476-9 | 29,78 |
| 31486-8 | 12,74 |
| 31491-2 | 34,44 |
| 31501-8 | 12,38 |
| 31506-3 | 33,38 |

| | | | |
|--------------------------------|-----|---------|-------|
| MESSING poliert brass polished | 1,0 | 28752-0 | 38,08 |
| MESSING poliert brass polished | 2,5 | 28750-6 | 95,20 |

| | |
|---------|-------|
| 28753-7 | 38,92 |
| 28751-3 | 97,70 |

Bitte fordern Sie unsere Pflegehinweise für Messingprofile an!
Please ask for our care tips for brass profiles!

Aluminium mit abriebfester Spezialmaillierung, gebohrt/ aluminium enameled, hard wearing, drilled



| | | | | | |
|----------------------|-----|---------|--------|---------|--------|
| Farbton - dunkelgrau | 1,0 | 40060-8 | 37,66 | 40061-5 | 38,82 |
| Farbton - dunkelgrau | 2,7 | 40070-7 | 101,58 | 40071-4 | 104,84 |

stainless steel-enameled, colour - dark grey



| | | | | | |
|---------------------------|-----|---------|--------|---------|--------|
| Farbton- silber metallic | 1,0 | 40210-7 | 50,14 | 40212-1 | 51,34 |
| Farbton - silber metallic | 2,7 | 40211-4 | 135,40 | 40213-8 | 138,62 |

stainless steel-enameled, colour - silver metallic



| | | | | | |
|---|-----|---------|--------|---------|--------|
| Edelst.-Emaillebeschichtung mit 4 nachleuchtenden Rillen Farbton - dunkelgrau | 1,0 | 40065-3 | 53,42 | 40067-7 | 54,64 |
| stainless steel-enameled with 4 photoluminescent grooves, colour - dark grey | 2,7 | 40075-2 | 144,24 | 40077-6 | 147,42 |

passende emaillierte Schrauben siehe Abschnitt 12/ suitable enameled screws see section 12

1. WINKELPROFILE + TREPPENKANTEN AUS ALUMINIUM + MESSING / 1. ANGLE EDGES + STAIR NOSINGS ALU + BRASS

Andere Eloxalfarben siehe Abschnitt 6, Lieferzeit 14 Tage/
other anodized colours see section 6,
delivery time 14 days

| Profi-Pack à 10 StUeck im Bund | | | |
|--------------------------------|-----------|-----------|-------------|
| professional packing à 10 pcs. | | | |
| Farbe/colour | L / l (m) | Art./ref. | €/Stk./pcs. |

| SB-Pack incl. Schr./ DUebel; VE 20 Stk. | |
|---|-------------|
| self-service-pack with screws/ dowels; à 20 pcs. | |
| Art./ref. | €/Stk./pcs. |

372 Treppenkante 30 x 30 x 2 mm R, Alu. eloxiert, gebohrt

stair nosing 30 x 30 x 2 mm R,
aluminium anodized, drilled

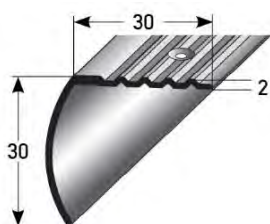

| | | | |
|-----------------------------|-----|---------|-------|
| silver | 1,0 | 66200-6 | 7,56 |
| silver | 2,7 | 66202-0 | 20,38 |
| goldfarbig, gold | 1,0 | 66204-4 | 7,88 |
| goldfarbig, gold | 2,7 | 66206-8 | 21,28 |
| bronzef. Hell,bronze light | 1,0 | 66208-2 | 8,70 |
| bronzef. hell bronze light | 2,7 | 66210-5 | 23,52 |
| bronzef. dunkel bronze dark | 1,0 | 66212-9 | 9,10 |
| bronzef. dunkel bronze dark | 2,7 | 66214-3 | 24,60 |

| | |
|---------|-------|
| 66216-7 | 8,44 |
| 66218-1 | 23,02 |
| 66220-4 | 8,76 |
| 66222-8 | 23,92 |
| 66224-2 | 9,58 |
| 66226-6 | 26,16 |
| 66228-0 | 9,98 |
| 66230-3 | 27,26 |

342 Treppenkante 22 x 30 mm, Aluminium eloxiert, gebohrt

stair nosing 22 x 30 mm,
aluminium anodized, drilled

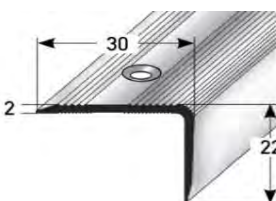

| | | | |
|-----------------------------|-----|---------|-------|
| silver | 1,0 | 65540-4 | 7,44 |
| silver | 2,7 | 65542-8 | 20,10 |
| goldfarbig, gold | 1,0 | 65544-2 | 7,70 |
| goldfarbig, gold | 2,7 | 65546-6 | 20,80 |
| bronzef. Hell,bronze light | 1,0 | 65548-0 | 8,68 |
| bronzef. hell bronze light | 2,7 | 65550-3 | 23,48 |
| bronzef. dunkel bronze dark | 1,0 | 65552-7 | 8,68 |
| bronzef. dunkel bronze dark | 2,7 | 65554-1 | 23,48 |

| | |
|---------|-------|
| 65560-2 | 8,22 |
| 65562-6 | 22,46 |
| 65564-0 | 8,50 |
| 65566-4 | 23,18 |
| 65568-8 | 9,88 |
| 65570-1 | 27,04 |
| 65572-5 | 9,48 |
| 65574-9 | 25,86 |

388 Treppenkante 27 x 27 mm, Aluminium eloxiert, gebohrt

stair nosing 27 x 27 mm,
aluminium anodized, drilled

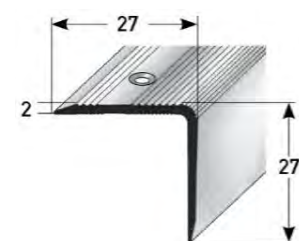

| | | | |
|-----------------------------|-----|---------|-------|
| silver | 1,0 | 67196-1 | 7,74 |
| silver | 2,7 | 67198-5 | 20,92 |
| goldfarbig, gold | 1,0 | 67200-5 | 8,02 |
| goldfarbig, gold | 2,7 | 67202-9 | 21,64 |
| bronzef. Hell,bronze light | 1,0 | 67204-3 | 9,00 |
| bronzef. hell bronze light | 2,7 | 67206-7 | 24,30 |
| bronzef. dunkel bronze dark | 1,0 | 67208-1 | 9,00 |
| bronzef. dunkel bronze dark | 2,7 | 67210-4 | 24,30 |

| | |
|---------|-------|
| 67216-6 | 8,10 |
| 67218-0 | 23,28 |
| 67220-3 | 8,82 |
| 67222-7 | 24,00 |
| 67224-1 | 10,20 |
| 67226-5 | 27,86 |
| 67228-9 | 9,80 |
| 67230-2 | 26,66 |

343 Treppenkante 32 x 30 mm, Aluminium eloxiert, gebohrt

stair nosing 32 x 30 mm,
aluminium anodized, drilled

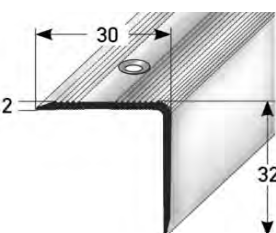

| | | | |
|-----------------------------|-----|---------|-------|
| silver | 1,0 | 65582-4 | 9,34 |
| silver | 2,7 | 65584-8 | 25,20 |
| goldfarbig, gold | 1,0 | 65586-2 | 9,94 |
| goldfarbig, gold | 2,7 | 65588-6 | 26,86 |
| bronzef. Hell,bronze light | 1,0 | 65590-9 | 11,22 |
| bronzef. hell bronze light | 2,7 | 65592-3 | 30,30 |
| bronzef. dunkel bronze dark | 1,0 | 65594-7 | 11,22 |
| bronzef. dunkel bronze dark | 2,7 | 65596-1 | 30,30 |

| | |
|---------|-------|
| 65602-9 | 10,10 |
| 65604-3 | 27,56 |
| 65606-7 | 10,72 |
| 65608-1 | 29,22 |
| 65610-4 | 12,42 |
| 65612-8 | 33,86 |
| 65614-2 | 12,00 |
| 65616-6 | 32,68 |

1. WINKELPROFILE + TREPPENKANTEN AUS ALUMINIUM + MESSING / 1. ANGLE EDGES + STAIR NOSINGS ALU + BRASS

Andere Eloxalfarben siehe Abschnitt 6, Lieferzeit 14 Tage/ other anodized colours see section 6, delivery time 14 days

| Profi-Pack à 10 StUeck im Bund | | | |
|--------------------------------|-----------|-----------|-------------|
| professional packing à 10 pcs. | | | |
| Farbe/colour | L / l (m) | Art./ref. | €/Stk./pcs. |

| SB-Pack incl. Schr./ DUebel; VE 20 Stk. | |
|--|-------------|
| self-service-pack with screws/ dowels; à 20 pcs. | |
| Art./ref. | €/Stk./pcs. |

344 Treppenkante 42 x 30 mm, Aluminium eloxiert, gebohrt

stair nosing 42 x 30 mm, aluminium anodized, drilled

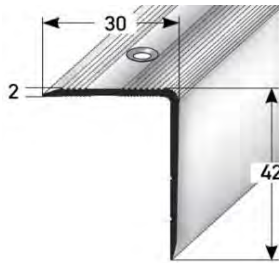

| | | | |
|-----------------------------|---------------------|-------------------------|-----------------------|
| silver | 1.0 | 65624-1 | 10,80 |
| silver | 2.7 | 65626-5 | 29,18 |
| goldfarbig, gold | 1.0 | 65628-9 | 11,18 |
| goldfarbig, gold | 2.7 | 65630-2 | 30,20 |
| bronzef. Hell,bronze light | 1.0 | 65632-6 | 12,08 |
| bronzef. hell bronze light | 2.7 | 65634-0 | 32,62 |
| bronzef. dunkel bronze dark | 1.0 | 65636-4 | 12,08 |
| bronzef. dunkel bronze dark | 2.7 | 65638-8 | 32,62 |

| | |
|-------------------------|-----------------------|
| 65644-9 | 11,58 |
| 65646-3 | 31,56 |
| 65648-7 | 11,96 |
| 65650-0 | 32,58 |
| 65652-4 | 13,28 |
| 65654-8 | 36,20 |
| 65656-2 | 12,86 |
| 65658-6 | 35,00 |

389 Treppenkante 42 x 40 mm, Aluminium eloxiert, gebohrt

stair nosing 42 x 40 mm, aluminium anodized, drilled

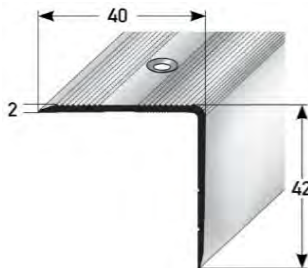

| | | | |
|-----------------------------|---------------------|-------------------------|-----------------------|
| silver | 1.0 | 67152-7 | 12,28 |
| silver | 2.7 | 67154-1 | 33,16 |
| goldfarbig, gold | 1.0 | 67156-5 | 12,72 |
| goldfarbig, gold | 2.7 | 67158-9 | 34,34 |
| bronzef. Hell,bronze light | 1.0 | 67160-2 | 14,22 |
| bronzef. hell bronze light | 2.7 | 67162-6 | 38,38 |
| bronzef. dunkel bronze dark | 1.0 | 67164-0 | 14,22 |
| bronzef. dunkel bronze dark | 2.7 | 67166-4 | 38,38 |

| | |
|-------------------------|-----------------------|
| 67172-5 | 13,04 |
| 67174-9 | 35,54 |
| 67176-3 | 13,50 |
| 67178-7 | 36,74 |
| 67180-0 | 15,40 |
| 67182-4 | 41,94 |
| 67184-8 | 14,98 |
| 67186-2 | 40,76 |

345 Treppenkante 52 x 30 mm, Aluminium eloxiert, gebohrt

stair nosing 52 x 30 mm, aluminium anodized, drilled

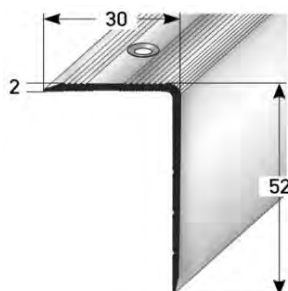

| | | | |
|-----------------------------|---------------------|-------------------------|-----------------------|
| silver | 1.0 | 65666-1 | 12,28 |
| silver | 2.7 | 65668-5 | 33,16 |
| goldfarbig, gold | 1.0 | 65670-8 | 12,72 |
| goldfarbig, gold | 2.7 | 65672-2 | 34,34 |
| bronzef. Hell,bronze light | 1.0 | 65674-6 | 14,22 |
| bronzef. hell bronze light | 2.7 | 65676-0 | 38,38 |
| bronzef. dunkel bronze dark | 1.0 | 65678-4 | 14,22 |
| bronzef. dunkel bronze dark | 2.7 | 65680-7 | 38,38 |

| | |
|-------------------------|-----------------------|
| 65686-9 | 13,04 |
| 65688-3 | 35,54 |
| 65690-6 | 13,50 |
| 65692-0 | 36,74 |
| 65694-4 | 15,40 |
| 65696-8 | 41,94 |
| 65698-2 | 14,98 |
| 65700-2 | 40,76 |

1. WINKELPROFILE + TREPPENKANTEN AUS ALUMINIUM + MESSING / 1. ANGLE EDGES + STAIR NOSINGS ALU + BRASS

Andere Eloxalfarben siehe Abschnitt 6, Lieferzeit 14 Tage/
other anodized colours see section 6, delivery time 14 days

9 5 Treppenkante 15 x 40 mm, Aluminium eloxiert, gebohrt

stair nosing 15 x 40 mm, aluminium anodized, drilled

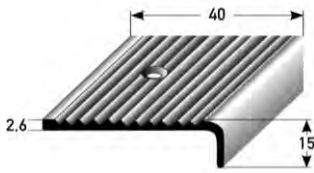

8 7

| Profi-Pack à 10 StUeck im Bund | | | |
|---------------------------------|-----------|-----------|-------------|
| professional packing à 10 pcs. | | | |
| Farbe/colour | L / l (m) | Art./ref. | €/Stk./pcs. |
| silver | 1,0 | 41100-0 | 11,22 |
| silver | 2,7 | 41110-9 | 30,34 |
| goldfarbig, gold | 1,0 | 41120-8 | 11,66 |
| goldfarbig, gold | 2,7 | 41130-7 | 31,42 |
| bronzef. Hell,bronze light | 1,0 | 41140-6 | 12,68 |
| bronzef. hell bronze light | 2,7 | 41150-5 | 34,20 |
| bronzef. dunkel bronze dark | 1,0 | 41160-4 | 12,68 |
| bronzef. dunkel bronze dark | 2,7 | 41170-3 | 34,20 |
| Aluminium blank aluminium plain | 1,0 | 41180-2 | 9,12 |
| Aluminium blank aluminium plain | 2,7 | 41190-1 | 24,72 |

| SB-Pack incl. Schr./DUebel; VE 20 Stk. | |
|---|-------------|
| self-service-pack with screws/dowels; à 20 pcs. | |
| Art./ref. | €/Stk./pcs. |
| 41105-5 | 12,04 |
| 41115-4 | 32,50 |
| 41125-3 | 12,44 |
| 41135-2 | 33,58 |
| 41145-1 | 13,86 |
| 41155-0 | 37,40 |
| 41165-9 | 13,46 |
| 41175-8 | 36,38 |
| 41185-7 | 9,96 |
| 41195-6 | 26,92 |

8 7 Treppenkante 23 x 40 mm, Aluminium eloxiert, gebohrt

stair nosing 23 x 40 mm, aluminium anodized, drilled

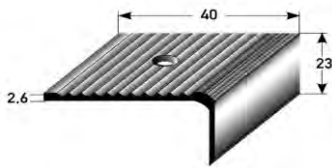

| | | | |
|-----------------------|-----|---------|-------|
| Silver colored | 0,9 | 29430-6 | 10,80 |
| Silver colored | 1,0 | 29435-1 | 12,02 |
| Silver colored | 2,7 | 29440-5 | 32,46 |
| gold coloured | 0,9 | 29445-0 | 11,20 |
| gold coloured | 1,0 | 29450-4 | 12,46 |
| gold coloured | 2,7 | 29455-9 | 33,64 |
| bronze light coloured | 0,9 | 29460-3 | 12,24 |
| bronze light coloured | 1,0 | 29465-8 | 13,62 |
| bronze light coloured | 2,7 | 29470-2 | 36,78 |
| bronze dark coloured | 0,9 | 29475-7 | 12,24 |
| bronze dark coloured | 1,0 | 29480-1 | 13,62 |
| bronze dark coloured | 2,7 | 29485-6 | 36,78 |

| | |
|---------|-------|
| 29436-8 | 12,82 |
| 29441-2 | 34,64 |
| 29451-1 | 13,24 |
| 29456-6 | 35,84 |
| 29466-5 | 14,84 |
| 29471-9 | 40,08 |
| 29481-8 | 14,44 |
| 29486-3 | 38,98 |

Aluminium mit abriebfester Spezialmaillierung, gebohrt/ aluminium enameled, hard wearing, drilled



| | | | |
|----------------------|-----|---------|--------|
| Farbton - dunkelgrau | 1,0 | 40080-6 | 40,06 |
| Farbton - dunkelgrau | 2,7 | 40090-5 | 108,10 |

| | |
|---------|--------|
| 40081-3 | 41,20 |
| 40091-2 | 111,30 |

stainless steel-enameled, colour - dark grey



| | | | |
|---------------------------|-----|---------|--------|
| Farbton- silber metallic | 1,0 | 40230-5 | 45,98 |
| Farbton - silber metallic | 2,7 | 40231-2 | 124,20 |

| | |
|---------|--------|
| 40232-9 | 47,16 |
| 40233-6 | 127,42 |

stainless steel-enameled, colour - silver metallic



| Edelst.-Emailliebeschichtung mit 4 nachleuchtenden Rillen Farbton - dunkelgrau | | | |
|--|-----|---------|--------|
| Edelst.-Emailliebeschichtung | 1,0 | 40085-1 | 55,80 |
| Edelst.-Emailliebeschichtung | 2,7 | 40095-0 | 150,72 |

| | |
|---------|--------|
| 40087-5 | 57,06 |
| 40097-4 | 154,00 |

stainless steel-enameled with 5 photoluminescent grooves, colour - dark grey

passende emaillierte Schrauben siehe Abschnitt 12/ suitable enameled screws see section 12

1. WINKELPROFILE + TREPPENKANTEN AUS ALUMINIUM + MESSING / 1. ANGLE EDGES + STAIR NOSINGS ALU + BRASS

Andere Eloxalfarben siehe Abschnitt 6,
Lieferzeit 14 Tage/ other anodized colours see
section 6, delivery time 14 days

8 9 Winkelprofil 10 x 24,5 mm, Aluminium eloxiert, gebohrt

angle edge 10 x 24,5 mm,
aluminium anodized, drilled



| Profi-Pack à 10 StÜeck im Bund | | | |
|--------------------------------|-----------|-----------|-------------|
| professional packing à 10 pcs. | | | |
| Farbe/colour | L / l (m) | Art./ref. | €/Stk./pcs. |

| SB-Pack incl. Schr./ DUebel; VE 20 Stk. | |
|---|-------------|
| self-service-pack with screws/ dowels; à 20 pcs. | |
| Art./ref. | €/Stk./pcs. |

| | | | |
|----------------------|---------------------|-------------------------|-----------------------|
| Silver colored | 0.8 | 4480-2 | 3.32 |
| Silver colored | 0.9 | 4490-1 | 3.72 |
| Silver colored | 1.0 | 4500-7 | 4.14 |
| Silver colored | 1.2 | 4510-6 | 4.96 |
| Silver colored | 2.0 | 4520-5 | 8.28 |
| Silver colored | 2.7 | 4530-4 | 11.18 |
| gold colored | 0.8 | 4580-9 | 4.16 |
| gold colored | 0.9 | 4590-8 | 4.70 |
| gold colored | 1.0 | 4600-4 | 5.20 |
| gold colored | 1.2 | 4610-3 | 6.26 |
| gold colored | 2.0 | 4620-2 | 10.40 |
| gold colored | 2.7 | 4630-1 | 14.06 |
| bronze light colored | 0.8 | 4680-6 | 4.40 |
| bronze light colored | 0.9 | 4690-5 | 4.96 |
| bronze light colored | 1.0 | 4700-1 | 5.52 |
| bronze light colored | 1.2 | 4710-0 | 6.62 |
| bronze light colored | 2.0 | 4720-9 | 11.06 |
| bronze light colored | 2.7 | 4730-8 | 14.90 |
| bronze dark | 0.8 | 4780-3 | 4.40 |
| bronze dark | 0.9 | 4790-2 | 4.96 |
| bronze dark | 1.0 | 4800-8 | 5.52 |
| bronze dark | 1.2 | 4810-7 | 6.62 |
| bronze dark | 2.0 | 4820-6 | 11.06 |
| bronze dark | 2.7 | 4830-5 | 14.90 |
| gold light | 0.8 | 70580-2 | 4.16 |
| gold light | 0.9 | 70582-6 | 4.70 |
| gold light | 1.0 | 70584-0 | 5.20 |
| gold light | 1.2 | 70586-4 | 6.26 |
| gold light | 2.0 | 70588-8 | 10.40 |
| gold light | 2.7 | 70590-1 | 14.06 |
| stainless steel | 0.8 | 70592-5 | 4.40 |
| stainless steel | 0.9 | 70594-9 | 4.96 |
| stainless steel | 1.0 | 70596-3 | 5.52 |
| stainless steel | 1.2 | 70598-7 | 6.62 |
| stainless steel | 2.0 | 70600-7 | 11.06 |
| stainless steel | 2.7 | 70602-1 | 14.90 |

| | |
|-------------------------|-----------------------|
| 4491-8 | 4.46 |
| 4501-4 | 4.88 |
| 4521-2 | 9.76 |
| 4531-1 | 13.40 |
| 4591-5 | 5.50 |
| 4601-1 | 5.98 |
| 4621-9 | 12.08 |
| 4631-8 | 16.50 |
| 4691-2 | 5.88 |
| 4701-8 | 6.44 |
| 4721-6 | 12.88 |
| 4731-5 | 17.68 |
| 4791-9 | 5.76 |
| 4801-5 | 6.32 |
| 4821-3 | 12.66 |
| 4831-2 | 17.32 |
| 70604-5 | 5.50 |
| 70606-9 | 5.98 |
| 70608-3 | 12.08 |
| 70610-6 | 16.50 |
| 70612-0 | 5.76 |
| 70614-4 | 6.32 |
| 70616-8 | 12.66 |
| 70618-2 | 17.32 |

| | | | | | | |
|----------------------------|--------------------------|---------------------|-------------------------|-----------------------|-------------------------|-----------------------|
| Holzdekorfolie/ wood decor | beech, Buche | 1.0 | 38700-8 | 9.56 | 38701-5 | 10.42 |
| | beech, Buche | 2.7 | 38710-7 | 25.86 | 38711-4 | 28.16 |
| | oak, Eiche | 1.0 | 38720-6 | 9.56 | 38721-3 | 10.42 |
| | oak, Eiche | 2.7 | 38730-5 | 25.86 | 38731-2 | 28.16 |
| | maple, Ahorn | 1.0 | 38740-4 | 9.56 | 38741-1 | 10.42 |
| | maple, Ahorn | 2.7 | 38750-3 | 25.86 | 38751-0 | 28.16 |
| | cherry, Kirsche | 1.0 | 38760-2 | 9.56 | 38761-9 | 10.42 |
| | cherry, Kirsche | 2.7 | 38765-7 | 25.86 | 38766-4 | 28.16 |
| | rustic oak Eiche rustik. | 1.0 | 38770-1 | 9.56 | 38771-8 | 10.42 |
| | rustic oak Eiche rustik. | 2.7 | 38775-6 | 25.86 | 38776-3 | 28.16 |

1. WINKELPROFILE + TREPPENKANTEN AUS ALUMINIUM + MESSING / 1. ANGLE EDGES + STAIR NOSINGS ALU + BRASS

9 1 Die Eloxalfarben siehe Abschnitt 6, Lieferzeit 14 Tage/
Anodized colours see section 6, delivery time 14 days

Treppenkante 20 x 40 mm, Aluminium eloxiert, gebohrt

stair nosing 20 x 40 mm, aluminium anodized, drilled

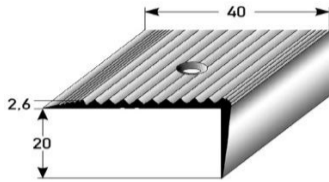

9 7

Bitte fordern Sie unsere Pflegehinweise für Messingprofile an!

Please ask for our care tips for brass profiles!

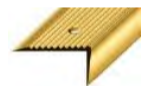

| Profi-Pack à 10 StUeck im Bund | | | |
|--------------------------------|-----------|-----------|-------------|
| professional packing à 10 pcs. | | | |
| Farbe/colour | L / l (m) | Art./ref. | €/Stk./pcs. |

| | | | |
|-----------------------|-----|--------|-------|
| silver coloured | 0.8 | 7080-1 | 8.34 |
| silver coloured | 0.9 | 7090-0 | 9.38 |
| silver coloured | 1.0 | 7100-6 | 10.42 |
| silver coloured | 1.2 | 7110-5 | 12.50 |
| silver coloured | 2.0 | 7120-4 | 20.84 |
| silver coloured | 2.7 | 7130-3 | 28.14 |
| gold coloured | 0.8 | 7180-8 | 10.26 |
| gold coloured | 0.9 | 7190-7 | 11.50 |
| gold coloured | 1.0 | 7200-3 | 12.78 |
| gold coloured | 1.2 | 7210-2 | 15.34 |
| gold coloured | 2.0 | 7220-1 | 25.58 |
| gold coloured | 2.7 | 7230-0 | 34.54 |
| bronze light coloured | 0.8 | 7280-5 | 11.16 |
| bronze light coloured | 0.9 | 7290-4 | 12.56 |
| bronze light coloured | 1.0 | 7300-0 | 13.96 |
| bronze light coloured | 1.2 | 7310-9 | 16.78 |
| bronze light coloured | 2.0 | 7320-8 | 27.90 |
| bronze light coloured | 2.7 | 7330-7 | 37.70 |
| bronze dark coloured | 0.8 | 7380-2 | 11.16 |
| bronze dark coloured | 0.9 | 7390-1 | 12.56 |
| bronze dark coloured | 1.0 | 7400-7 | 13.96 |
| bronze dark coloured | 1.2 | 7410-6 | 16.78 |
| bronze dark coloured | 2.0 | 7420-5 | 27.90 |
| bronze dark coloured | 2.7 | 7430-4 | 37.70 |

| | | | |
|--------------------------------|-----|---------|--------|
| MESSING poliert brass polished | 1.0 | 28722-3 | 44.26 |
| MESSING poliert brass polished | 2.5 | 28720-9 | 110.66 |

| SB-Pack incl. Schr./DUebel; VE 20 Stk. | |
|---|-------------|
| self-service-pack with screws/dowels; à 20 pcs. | |
| Art./ref. | €/Stk./pcs. |

| | |
|--------|-------|
| 7091-7 | 10.12 |
| 7101-3 | 11.16 |
| 7111-2 | 13.38 |
| 7121-1 | 22.32 |
| 7131-0 | 30.36 |
| 7191-4 | 12.22 |
| 7201-0 | 13.60 |
| 7211-9 | 16.30 |
| 7221-8 | 27.24 |
| 7231-7 | 36.70 |
| 7291-1 | 13.62 |
| 7301-7 | 15.14 |
| 7311-6 | 18.22 |
| 7321-5 | 30.34 |
| 7331-4 | 40.92 |
| 7391-8 | 13.28 |
| 7401-4 | 14.76 |
| 7411-3 | 17.70 |
| 7421-2 | 29.54 |
| 7431-1 | 39.86 |

Treppenk. 20 x 40 mm, Alu. mit abriebf. Spezial. gebohrt

stair nosing 20 x 40 mm, aluminium hard wearing enamel, drilled

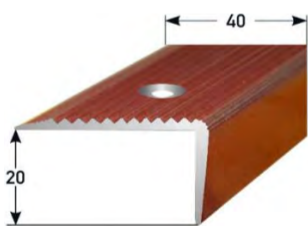

| | | | |
|---------------------------------|-----|---------|--------|
| dunkelgrau dark grey | 1.0 | 40000-4 | 40.38 |
| dunkelgrau dark grey | 2.7 | 40010-3 | 109.02 |
| silber metallic silver metallic | 1.0 | 40150-6 | 46.34 |
| silber metallic silver metallic | 2.7 | 40151-3 | 125.14 |
| gold | 1.0 | 64000-4 | 40.38 |
| gold | 2.7 | 64002-8 | 109.02 |
| blau, blUe | 1.0 | 64004-2 | 40.38 |
| blau, blUe | 2.7 | 64006-6 | 109.02 |
| rot, red | 1.0 | 64008-0 | 40.38 |
| rot, red | 2.7 | 64010-3 | 109.02 |
| grUen, green | 1.0 | 64012-7 | 40.38 |
| grUen, green | 2.7 | 64014-1 | 109.02 |
| schwarz, black | 1.0 | 64016-5 | 40.38 |
| schwarz, black | 2.7 | 64018-9 | 109.02 |

| | |
|---------|--------|
| 40001-1 | 41.56 |
| 40011-0 | 112.24 |
| 40152-0 | 47.54 |
| 40153-7 | 128.34 |
| 64022-6 | 41.56 |
| 64024-0 | 112.24 |
| 64026-4 | 41.56 |
| 64028-8 | 112.24 |
| 64030-1 | 41.56 |
| 64032-5 | 112.24 |
| 64034-9 | 41.56 |
| 64036-3 | 112.24 |
| 64038-7 | 41.56 |
| 64040-0 | 112.24 |

Treppenk. 20 x 40 mm, Alu, abriebf. Spezial. nachleuchtend

stair nosing 20 x 40 mm, aluminium hard wearing enamel, drilled, 5 photoluminescent grooves, photoluminescent

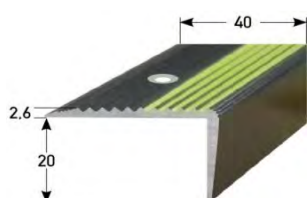

| | | | |
|-----------------------|-----|---------|--------|
| dunkelgrau dark grey | 1.0 | 40005-9 | 56.14 |
| dunkelgrau, dark grey | 2.7 | 40015-8 | 151.68 |
| silber metallic | 1.0 | 40140-7 | 62.14 |
| silber metallic | 2.7 | 40142-1 | 167.80 |
| gold | 1.0 | 64044-8 | 56.14 |
| gold | 2.7 | 64046-2 | 151.68 |
| blau, blUe | 1.0 | 64048-6 | 56.14 |
| blau, blUe | 2.7 | 64050-9 | 151.68 |
| rot, red | 1.0 | 64052-3 | 56.14 |
| rot, red | 2.7 | 64054-7 | 151.68 |
| grUen, green | 1.0 | 64056-1 | 56.14 |
| grUen, green | 2.7 | 64058-5 | 151.68 |
| schwarz, black | 1.0 | 64060-8 | 56.14 |
| schwarz, black | 2.7 | 64062-2 | 151.68 |

| | |
|---------|--------|
| 40007-3 | 57.36 |
| 40017-2 | 154.88 |
| 40144-5 | 63.32 |
| 40146-9 | 170.98 |
| 64066-0 | 57.36 |
| 64068-4 | 154.88 |
| 64070-7 | 57.36 |
| 64072-1 | 154.88 |
| 64074-5 | 57.36 |
| 64076-9 | 154.88 |
| 64078-3 | 57.36 |
| 64080-6 | 154.88 |
| 64082-0 | 57.36 |
| 64084-4 | 154.88 |

1. WINKELPROFILE + TREPPENKANTEN AUS ALUMINIUM + MESSING / 1. ANGLE EDGES + STAIR NOSINGS ALU + BRASS

Andere Eloxalfarben siehe Abschnitt 6, Lieferzeit 14 Tage/

8 4 Anodized colours see section 6, delivery time 14 days

| Profi-Pack à 10 StUeck im Bund | | | | SB-Pack incl. Schr./DUebel; VE 20 Stk. | |
|--------------------------------|-----------|-----------|-------------|---|-------------|
| professional packing à 10 pcs. | | | | self-service-pack with screws/dowels; à 20 pcs. | |
| Farbe/colour | L / l (m) | Art./ref. | €/Stk./pcs. | Art./ref. | €/Stk./pcs. |

Treppenkante 28 x 50 mm, Aluminium eloxiert, gebohrt

stair nosing 28 x 50 mm, aluminium anodized, drilled

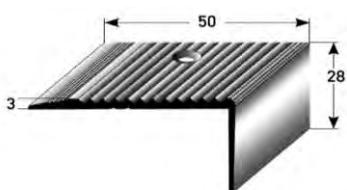

| | | | | | |
|-----------------------------|-----|---------|-------|---------|-------|
| silver | 1,0 | 31410-3 | 16,18 | | |
| silver | 2,7 | 31415-8 | 43,60 | 31416-5 | 45,86 |
| goldfarbig, gold | 1,0 | 31420-2 | 16,28 | | |
| goldfarbig, gold | 2,7 | 31425-7 | 43,96 | 31426-4 | 46,14 |
| bronzef. Hell,bronze light | 1,0 | 31430-1 | 19,04 | | |
| bronzef. hell bronze light | 2,7 | 31435-6 | 51,48 | 31436-3 | 54,68 |
| bronzef. dunkel bronze dark | 1,0 | 31440-0 | 19,04 | | |
| bronzef. dunkel bronze dark | 2,7 | 31445-5 | 51,48 | 31446-2 | 53,62 |

Aluminium mit abriebfester Spezialmaillierung, gebohrt/ aluminium enameled, hard wearing, drilled



| | | | | | |
|----------------------|-----|---------|--------|---------|--------|
| Farbton - dunkelgrau | 1,0 | 40040-0 | 44,16 | 40041-7 | 45,36 |
| Farbton - dunkelgrau | 2,7 | 40050-9 | 119,28 | 40051-6 | 122,52 |



| | | | | | |
|----------------------|-----|---------|--------|---------|--------|
| Farbton - dunkelgrau | 1,0 | 40190-2 | 50,14 | 40192-6 | 51,34 |
| Farbton - dunkelgrau | 2,7 | 40191-9 | 135,40 | 40193-3 | 138,62 |



Edelst.-Emaillbeschichtung mit 4 nachleuchtenden Rillen Farbton - dunkelgrau

| | | | | | |
|----------------------------|-----|---------|--------|---------|--------|
| Edelst.-Emaillbeschichtung | 1,0 | 40045-5 | 59,94 | 40047-9 | 61,16 |
| Edelst.-Emaillbeschichtung | 2,7 | 40055-4 | 161,86 | 40057-8 | 165,12 |

stainless steel-enameled with 5 photoluminescent grooves, colour - dark grey

passende emaillierte Schrauben siehe Abschnitt 12/ suitable enameled screws see section 12

Treppenkante 42 x 50 mm, Aluminium eloxiert, gebohrt

stair nosing 42 x 50 mm, aluminium anodized, drilled

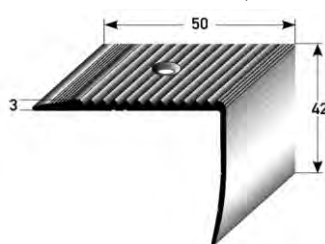

| | | | | | |
|-----------------------------|-----|--------|-------|--------|-------|
| silver | 1,0 | 1410-3 | 13,92 | | |
| silver | 2,5 | 1415-8 | 34,80 | 1416-5 | 36,90 |
| goldfarbig, gold | 1,0 | 1420-2 | 19,58 | | |
| goldfarbig, gold | 2,5 | 1425-7 | 48,92 | 1426-4 | 51,08 |
| bronzef. Hell,bronze light | 1,0 | 1430-1 | 22,88 | | |
| bronzef. hell bronze light | 2,5 | 1435-6 | 57,30 | 1436-3 | 60,50 |
| bronzef. dunkel bronze dark | 1,0 | 1440-0 | 22,88 | | |
| bronzef. dunkel bronze dark | 2,5 | 1445-5 | 57,30 | 1446-2 | 59,46 |

Aluminium mit abriebfester Spezialmaillierung, gebohrt/ aluminium enameled, hard wearing, drilled



| | | | | | |
|----------------------|-----|---------|--------|---------|--------|
| Farbton - dunkelgrau | 1,0 | 40020-2 | 41,12 | 40021-9 | 45,70 |
| Farbton - dunkelgrau | 2,5 | 40030-1 | 102,76 | 40031-8 | 114,18 |



| | | | | | |
|---------------------------|-----|---------|--------|---------|--------|
| Farbton- silber metallic | 1,0 | 40170-4 | 47,58 | 40172-8 | 52,14 |
| Farbton - silber metallic | 2,5 | 40171-1 | 118,90 | 40173-5 | 130,30 |



| | | | | | |
|----------------------------|-----|---------|--------|---------|--------|
| Edelst.-Emaillbeschichtung | 1,0 | 40025-7 | 56,90 | 40027-1 | 58,18 |
| Edelst.-Emaillbeschichtung | 2,5 | 40035-6 | 142,26 | 40037-0 | 145,48 |

stainless steel-enameled with 5 photoluminescent grooves, colour - dark grey

passende emaillierte Schrauben siehe Abschnitt 12/ suitable enameled screws see section 12

1. WINKELPROFILE + TREPPENKANTEN AUS ALUMINIUM + MESSING / 1. ANGLE EDGES + STAIR NOSINGS ALU + BRASS

| Profi-Pack à 5 StUeck im Bund | | | |
|-------------------------------|-----------|-----------|-------------|
| professional packing à 5 pcs. | | | |
| Farbe/colour | L / l (m) | Art./ref. | €/Stk./pcs. |

339 penkante 55 x 69 mm, Aluminium eloxiert, gebohrt

stair nosing 55 x 69 mm, aluminium anodized, drilled

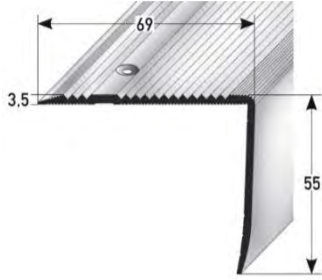

| | | | |
|-----------------------------|-----|---------|-------|
| silver | 1.0 | 65504-6 | 19,60 |
| silver | 2.7 | 65506-0 | 52,90 |
| goldfarbig, gold | 1.0 | 65508-4 | 20,30 |
| goldfarbig, gold | 2.7 | 65510-7 | 54,84 |
| bronzef. Hell, bronze light | 1.0 | 65512-1 | 22,74 |
| bronzef. hell bronze light | 2.7 | 65514-5 | 61,38 |
| bronzef. dunkel bronze dark | 1.0 | 65516-9 | 22,74 |
| bronzef. dunkel bronze dark | 2.7 | 65518-3 | 61,38 |

passende Schrauben siehe Abschnitt 12/ suitable screws see section 12

| Profi-Pack à 10 StUeck im Bund | | | |
|--------------------------------|-----------|-----------|-------------|
| professional packing à 10 pcs. | | | |
| Farbe/colour | L / l (m) | Art./ref. | €/Stk./pcs. |

| SB-Pack incl. Schr./ DUebel: VE 20 Stk. | |
|---|-------------|
| self-service-pack with screws/ dowels; à 20 pcs. | |
| Art./ref. | €/Stk./pcs. |

127 Vorstossprofil 2 x 25 mm, gebohrt

edge profile 2 x 25 mm, drilled

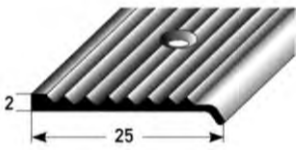

| | | | |
|-----------------------------|-----|---------|-------|
| silver | 1.0 | 69960-6 | 5,08 |
| silver | 2.5 | 69962-0 | 12,70 |
| goldfarbig, gold | 1.0 | 69964-4 | 5,26 |
| goldfarbig, gold | 2.5 | 69966-8 | 13,18 |
| bronzef. Hell, bronze light | 1.0 | 69968-2 | 6,44 |
| bronzef. hell bronze light | 2.5 | 69970-5 | 16,12 |
| bronzef. dunkel bronze dark | 1.0 | 69972-9 | 6,44 |
| bronzef. dunkel bronze dark | 2.5 | 69974-3 | 16,12 |

| | |
|---------|-------|
| 69978-1 | 5,86 |
| 69980-4 | 15,02 |
| 69982-8 | 6,04 |
| 69984-2 | 15,50 |
| 69986-6 | 7,22 |
| 69988-0 | 18,56 |
| 69990-3 | 7,22 |
| 69992-7 | 18,56 |

| | | | |
|-----------------------------------|-----|---------|-------|
| MESSING poliert brass polished | 1.0 | 28210-5 | 22,72 |
| MESSING poliert brass polished | 2.0 | 28220-4 | 45,44 |
| MESSING poliert brass polished | 2.5 | 28200-6 | 56,80 |

| | |
|---------|-------|
| 28211-2 | 23,72 |
| 28201-3 | 59,32 |

Bitte fordern Sie unsere Pflegehinweise für Messingprofile an!
care tips for brass profiles!

Please ask for our

129 Vorstossprofil 3 x 30 mm, gebohrt

edge profile 3 x 30 mm, drilled

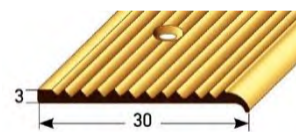

| | | | |
|-----------------------------------|-----|---------|-------|
| MESSING poliert brass polished | 1.0 | 28630-1 | 25,00 |
| MESSING poliert brass polished | 2.0 | 28640-0 | 50,00 |
| MESSING poliert brass polished | 2.5 | 28650-9 | 62,50 |

| | |
|---------|-------|
| 28631-8 | 26,02 |
| 28651-6 | 65,10 |

Bitte fordern Sie unsere Pflegehinweise für Messingprofile an!
care tips for brass profiles!

Please ask for our

128 Vorstossprofil 3 x 35 mm, gebohrt

edge profile 3 x 35 mm, drilled

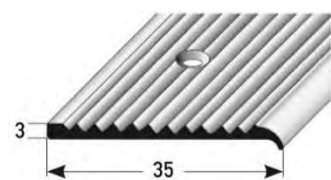

| | | | |
|-----------------------------|-----|---------|-------|
| silver | 1.0 | 28530-4 | 8,72 |
| silver | 2.5 | 28535-9 | 21,84 |
| goldfarbig, gold | 1.0 | 28540-3 | 9,02 |
| goldfarbig, gold | 2.5 | 28545-8 | 22,60 |
| bronzef. Hell, bronze light | 1.0 | 28550-2 | 10,40 |
| bronzef. hell bronze light | 2.5 | 28555-7 | 26,00 |
| bronzef. dunkel bronze dark | 1.0 | 28560-1 | 10,40 |
| bronzef. dunkel bronze dark | 2.5 | 28565-6 | 26,00 |

| | |
|---------|-------|
| 28531-1 | 9,58 |
| 28536-6 | 23,98 |
| 28541-0 | 9,90 |
| 28546-5 | 24,78 |
| 28551-9 | 11,72 |
| 28556-4 | 29,20 |
| 28561-8 | 11,28 |
| 28566-3 | 28,22 |

| | | | |
|-----------------------------------|-----|---------|-------|
| MESSING poliert brass polished | 1.0 | 28610-3 | 31,94 |
| MESSING poliert brass polished | 2.0 | 28620-2 | 63,88 |
| MESSING poliert brass polished | 2.5 | 28600-4 | 79,86 |

| | |
|---------|-------|
| 28611-0 | 32,92 |
| 28601-1 | 82,40 |

Bitte fordern Sie unsere Pflegehinweise für Messingprofile an!
care tips for brass profiles!

Please ask for our

1. WINKELPROFILE + TREPPENKANTEN AUS ALUMINIUM + MESSING / 1. ANGLE EDGES + STAIR NOSINGS ALU + BRASS

Andere Eloxafarben siehe Abschnitt 6, Lieferzeit 14 Tage/ other anodized colours see section 6, delivery time 14 days

| Profi-Pack à 10 StUeck im Bund | | | |
|--------------------------------|-----------|-----------|-------------|
| professional packing à 10 pcs. | | | |
| Farbe/colour | L / l (m) | Art./ref. | €/Stk./pcs. |

| SB-Pack incl. Schr./ DUebel; VE 20 Stk. | |
|--|-------------|
| self-service-pack with screws/ dowels; à 20 pcs. | |
| Art./ref. | €/Stk./pcs. |

474 Fassonprofil 2 mm, Aluminium eloxiert, gebohrt

fasson stair nosing 2 mm, aluminium anodized, drilled



| | | | |
|-----------------------------|---------------------|-------------------------|-----------------------|
| silver | 1,0 | 70700-4 | 4,96 |
| silver | 2,7 | 70702-8 | 13,36 |
| goldfarbig, gold | 1,0 | 70704-2 | 5,22 |
| goldfarbig, gold | 2,7 | 70706-6 | 14,10 |
| bronzef. Hell,bronze light | 1,0 | 70708-0 | 5,70 |
| bronzef. hell bronze light | 2,7 | 70710-3 | 15,40 |
| bronzef. dunkel bronze dark | 1,0 | 70712-7 | 5,70 |
| bronzef. dunkel bronze dark | 2,7 | 70714-1 | 15,40 |

| | |
|-------------------------|-----------------------|
| 70716-5 | 5,74 |
| 70718-9 | 15,60 |
| 70720-2 | 6,02 |
| 70722-6 | 16,28 |
| 70724-0 | 6,88 |
| 70726-4 | 18,60 |
| 70728-8 | 6,52 |
| 70730-1 | 18,60 |

475 Fassonprofil 2,5 mm, Aluminium eloxiert, gebohrt

fasson stair nosing 2,5 mm, aluminium anodized, drilled

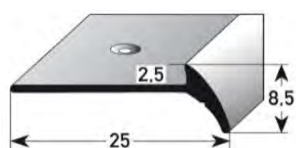

| | | | |
|-----------------------------|---------------------|-------------------------|-----------------------|
| silver | 1,0 | 70734-9 | 4,98 |
| silver | 2,7 | 70736-3 | 13,42 |
| goldfarbig, gold | 1,0 | 70738-7 | 5,26 |
| goldfarbig, gold | 2,7 | 70740-0 | 14,22 |
| bronzef. Hell,bronze light | 1,0 | 70742-4 | 5,74 |
| bronzef. hell bronze light | 2,7 | 70744-8 | 15,52 |
| bronzef. dunkel bronze dark | 1,0 | 70746-2 | 5,74 |
| bronzef. dunkel bronze dark | 2,7 | 70748-6 | 15,52 |

| | |
|-------------------------|-----------------------|
| 70750-9 | 5,8 |
| 70752-3 | 15,7 |
| 70754-7 | 6,06 |
| 70756-1 | 16,40 |
| 70758-5 | 6,92 |
| 70760-8 | 18,74 |
| 70762-2 | 6,56 |
| 70764-6 | 18,74 |

476 Fassonprofil 3 mm, Aluminium eloxiert, gebohrt

fasson stair nosing 3 mm, aluminium anodized, drilled

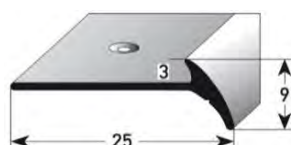

| | | | |
|-----------------------------|---------------------|-------------------------|-----------------------|
| silver | 1,0 | 70768-4 | 5,02 |
| silver | 2,7 | 70770-7 | 13,54 |
| goldfarbig, gold | 1,0 | 70772-1 | 5,30 |
| goldfarbig, gold | 2,7 | 70774-5 | 14,32 |
| bronzef. Hell,bronze light | 1,0 | 70776-9 | 5,80 |
| bronzef. hell bronze light | 2,7 | 70778-3 | 15,64 |
| bronzef. dunkel bronze dark | 1,0 | 70780-6 | 5,80 |
| bronzef. dunkel bronze dark | 2,7 | 70782-0 | 15,64 |

| | |
|-------------------------|-----------------------|
| 70784-4 | 5,82 |
| 70786-8 | 15,78 |
| 70788-2 | 6,10 |
| 70790-5 | 16,52 |
| 70792-9 | 6,96 |
| 70794-3 | 18,84 |
| 70796-7 | 6,60 |
| 70798-1 | 18,84 |



| |
|---|
| Befestigungsschenkel ausklinken attachment flanges notched |
| Befestigungsschenkel ausklinken und biegen attachment flanges notched and bent |

| | |
|---------------------------|----------------------|
| Art./ref. | €/m |
| 22240-8 | 5,72 |
| auf Anfrage on reqUest | |

1. WINKELPROFILE + TREPPENKANTEN AUS ALUMINIUM + MESSING / 1. ANGLE EDGES + STAIR NOSINGS ALU + BRASS

Andere Eloxalfarben siehe Abschnitt 6, Lieferzeit 14 Tage/ other anodized colours see section 6, delivery time 14 days

| Profi-Pack à 10 StUeck im Bund | | | |
|--------------------------------|-----------|-----------|-------------|
| professional packing à 10 pcs. | | | |
| Farbe/colour | L / l (m) | Art./ref. | €/Stk./pcs. |

| SB-Pack incl. Schr./ DUEBEL; VE 20 Stk. | |
|--|-------------|
| self-service-pack with screws/ dowels; à 20 pcs. | |
| Art./ref. | €/Stk./pcs. |

435 Treppenkante 10 x 37 x 2 mm, Aluminium eloxiert, gebohrt

stair nosing 10 x 37 x 2 mm, aluminium anodized, drilled

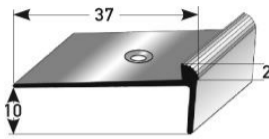

| | | | |
|-----------------------------|------------|----------------|--------------|
| silver | <u>1.0</u> | <u>68100-7</u> | <u>9,12</u> |
| silver | <u>2.7</u> | <u>68102-1</u> | <u>24,66</u> |
| goldfarbig, gold | <u>1.0</u> | <u>68104-5</u> | <u>9,66</u> |
| goldfarbig, gold | <u>2.7</u> | <u>68106-9</u> | <u>26,06</u> |
| bronzef. Hell,bronze light | <u>1.0</u> | <u>68108-3</u> | <u>10,86</u> |
| bronzef. hell bronze light | <u>2.7</u> | <u>68110-6</u> | <u>29,36</u> |
| bronzef. dunkel bronze dark | <u>1.0</u> | <u>68112-0</u> | <u>10,86</u> |
| bronzef. dunkel bronze dark | <u>2.7</u> | <u>68114-4</u> | <u>29,36</u> |

| | |
|----------------|--------------|
| <u>68118-2</u> | <u>9,94</u> |
| <u>68120-5</u> | <u>27,10</u> |
| <u>68122-9</u> | <u>10,46</u> |
| <u>68124-3</u> | <u>28,52</u> |
| <u>68126-7</u> | <u>11,68</u> |
| <u>68128-1</u> | <u>31,80</u> |
| <u>68130-4</u> | <u>11,68</u> |
| <u>68132-8</u> | <u>31,80</u> |

436 Treppenkante 24 x 37 x 2 mm, Aluminium eloxiert, gebohrt

stair nosing 24 x 37 x 2 mm, aluminium anodized, drilled

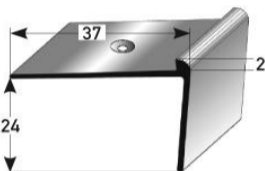

| | | | |
|-----------------------------|------------|----------------|--------------|
| silver | <u>1.0</u> | <u>68150-2</u> | <u>9,82</u> |
| silver | <u>2.7</u> | <u>68152-6</u> | <u>26,52</u> |
| goldfarbig, gold | <u>1.0</u> | <u>68154-0</u> | <u>10,32</u> |
| goldfarbig, gold | <u>2.7</u> | <u>68156-4</u> | <u>27,86</u> |
| bronzef. Hell,bronze light | <u>1.0</u> | <u>68158-8</u> | <u>11,60</u> |
| bronzef. hell bronze light | <u>2.7</u> | <u>68160-1</u> | <u>31,32</u> |
| bronzef. dunkel bronze dark | <u>1.0</u> | <u>68162-5</u> | <u>11,60</u> |
| bronzef. dunkel bronze dark | <u>2.7</u> | <u>68164-9</u> | <u>31,32</u> |

| | |
|----------------|--------------|
| <u>68168-7</u> | <u>10,6</u> |
| <u>68170-0</u> | <u>29,0</u> |
| <u>68172-4</u> | <u>11,14</u> |
| <u>68174-8</u> | <u>30,32</u> |
| <u>68176-2</u> | <u>12,42</u> |
| <u>68178-6</u> | <u>33,78</u> |
| <u>68180-9</u> | <u>12,42</u> |
| <u>68182-3</u> | <u>33,78</u> |

266 Treppenkante 40 x 37 x 2 mm, Aluminium eloxiert, gebohrt

stair nosing 40 x 37 x 2 mm, aluminium anodized, drilled

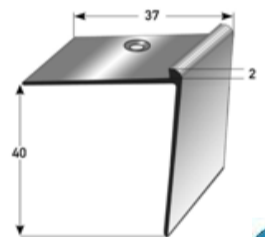

| | | | |
|-----------------------------|------------|----------------|--------------|
| silver | <u>1.0</u> | <u>46482-2</u> | <u>10,78</u> |
| silver | <u>2.7</u> | <u>46480-8</u> | <u>29,14</u> |
| goldfarbig, gold | <u>1.0</u> | <u>46492-1</u> | <u>11,22</u> |
| goldfarbig, gold | <u>2.7</u> | <u>46490-7</u> | <u>30,36</u> |
| bronzef. Hell,bronze light | <u>1.0</u> | <u>46502-7</u> | <u>12,74</u> |
| bronzef. hell bronze light | <u>2.7</u> | <u>46500-3</u> | <u>34,38</u> |
| bronzef. dunkel bronze dark | <u>1.0</u> | <u>46512-6</u> | <u>12,74</u> |
| bronzef. dunkel bronze dark | <u>2.7</u> | <u>46510-2</u> | <u>34,38</u> |

| | |
|----------------|--------------|
| <u>46486-0</u> | <u>11,60</u> |
| <u>46484-6</u> | <u>31,56</u> |
| <u>46496-9</u> | <u>12,04</u> |
| <u>46494-5</u> | <u>32,78</u> |
| <u>46506-5</u> | <u>13,54</u> |
| <u>46504-1</u> | <u>36,80</u> |
| <u>46516-4</u> | <u>13,54</u> |
| <u>46514-0</u> | <u>36,80</u> |

383 Treppen. 10 x 37 x 2,5 mm, Aluminium eloxiert, gebohrt

stair nosing 10 x 37 x 2,5 mm, aluminium anodized, drilled

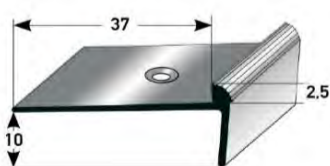

| | | | |
|-----------------------------|------------|----------------|--------------|
| silver | <u>1.0</u> | <u>66556-4</u> | <u>9,62</u> |
| silver | <u>2.7</u> | <u>66558-8</u> | <u>26,04</u> |
| goldfarbig, gold | <u>1.0</u> | <u>66560-1</u> | <u>10,16</u> |
| goldfarbig, gold | <u>2.7</u> | <u>66562-5</u> | <u>27,40</u> |
| bronzef. Hell,bronze light | <u>1.0</u> | <u>66564-9</u> | <u>11,36</u> |
| bronzef. hell bronze light | <u>2.7</u> | <u>66566-3</u> | <u>30,66</u> |
| bronzef. dunkel bronze dark | <u>1.0</u> | <u>66568-7</u> | <u>11,36</u> |
| bronzef. dunkel bronze dark | <u>2.7</u> | <u>66570-0</u> | <u>30,66</u> |

| | |
|----------------|--------------|
| <u>66580-9</u> | <u>10,44</u> |
| <u>66582-3</u> | <u>28,46</u> |
| <u>66584-7</u> | <u>10,96</u> |
| <u>66586-1</u> | <u>29,84</u> |
| <u>66588-5</u> | <u>12,16</u> |
| <u>66590-8</u> | <u>33,10</u> |
| <u>66592-2</u> | <u>12,16</u> |
| <u>66594-6</u> | <u>33,10</u> |



| | | |
|---|---------------------------|-------------|
| Befestigungsschenkel ausklinken attachment flanges notched | Art./ref. | €/m |
| | <u>22240-8</u> | <u>5,72</u> |
| Befestigungsschenkel ausklinken und biegen attachment flanges notched and bent | auf Anfrage on request | |

Andere Eloxalfarben siehe Abschnitt 6, Lieferzeit 14 Tage/ other anodized colours see section 6, delivery time 14 days

1. WINKELPROFILE + TREPPENKANTEN AUS ALUMINIUM + MESSING / 1. ANGLE EDGES + STAIR NOSINGS ALU + BRASS

| Profi-Pack à 10 StUeck im Bund | | | |
|--------------------------------|-----------|-----------|-------------|
| professional packing à 10 pcs. | | | |
| Farbe/colour | L / l (m) | Art./ref. | €/Stk./pcs. |

| SB-Pack incl. Schr./ DÜbel; VE 20 Stk. | |
|--|-------------|
| self-service-pack with screws/ dowels; à 20 pcs. | |
| Art./ref. | €/Stk./pcs. |

384 Treppen. 24 x 37 x 2,5 mm, Alum. eloxiert, geb.

stair nosing 24 x 37 x 2,5 mm, aluminium anodized, drilled

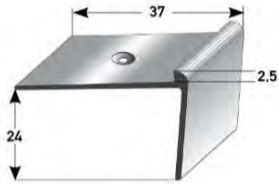

| | | | |
|-----------------------------|---------------------|-------------------------|-----------------------|
| silver | 1,0 | 66604-2 | 9,90 |
| silver | 2,7 | 66606-6 | 26,74 |
| goldfarbig, gold | 1,0 | 66608-0 | 10,40 |
| goldfarbig, gold | 2,7 | 66610-3 | 28,12 |
| bronzef. ,bronze light | 1,0 | 66612-7 | 11,66 |
| bronzef. hell bronze light | 2,7 | 66614-1 | 31,50 |
| bronzef. dunkel bronze dark | 1,0 | 66616-5 | 11,66 |
| bronzef. dunkel bronze dark | 2,7 | 66618-9 | 31,50 |

| | |
|-------------------------|-----------------------|
| 66628-8 | 10,72 |
| 66630-1 | 29,18 |
| 66632-5 | 11,22 |
| 66634-9 | 30,54 |
| 66636-3 | 12,48 |
| 66638-7 | 33,94 |
| 66640-0 | 12,48 |
| 66642-4 | 33,94 |

385 Treppen. 40 x 37 x 2,5 mm, Alu. eloxiert, geb.

stair nosing 40 x 37 x 2,5 mm, aluminium anodized, drilled

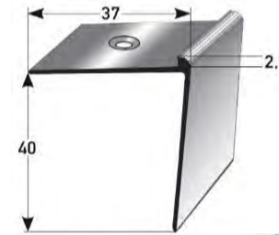

| | | | |
|-----------------------------|---------------------|-------------------------|-----------------------|
| silver | 1,0 | 66652-3 | 10,84 |
| silver | 2,7 | 66654-7 | 29,48 |
| goldfarbig, gold | 1,0 | 66656-1 | 11,26 |
| goldfarbig, gold | 2,7 | 66658-5 | 30,42 |
| bronzef. Hell,bronze light | 1,0 | 66660-8 | 13,40 |
| bronzef. hell bronze light | 2,7 | 66662-2 | 36,20 |
| bronzef. dunkel bronze dark | 1,0 | 66664-6 | 13,40 |
| bronzef. dunkel bronze dark | 2,7 | 66666-0 | 36,20 |

| | |
|-------------------------|-----------------------|
| 66676-9 | 11,7 |
| 66678-3 | 31,9 |
| 66680-6 | 12,08 |
| 66682-0 | 32,86 |
| 66684-4 | 14,22 |
| 66686-8 | 38,62 |
| 66688-2 | 14,22 |
| 66690-5 | 38,62 |

437 Treppen. 10 x 37 x 3 mm, Aluminium eloxiert, gebohrt

stair nosing 10 x 37 x 3 mm, aluminium anodized, drilled

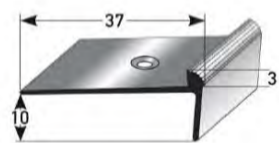

| | | | |
|-----------------------------|---------------------|-------------------------|-----------------------|
| silver | 1,0 | 68200-4 | 9,30 |
| silver | 2,7 | 68202-8 | 25,10 |
| goldfarbig, gold | 1,0 | 68204-2 | 9,82 |
| goldfarbig, gold | 2,7 | 68206-6 | 26,52 |
| bronzef. Hell,bronze light | 1,0 | 68208-0 | 11,00 |
| bronzef. hell bronze light | 2,7 | 68210-3 | 29,68 |
| bronzef. dunkel bronze dark | 1,0 | 68212-7 | 11,00 |
| bronzef. dunkel bronze dark | 2,7 | 68214-1 | 29,68 |

| | |
|-------------------------|-----------------------|
| 68218-9 | 10,12 |
| 68220-2 | 27,54 |
| 68222-6 | 10,64 |
| 68224-0 | 28,98 |
| 68226-4 | 11,82 |
| 68228-8 | 32,14 |
| 68230-1 | 11,82 |
| 68232-5 | 32,14 |

9 4 Treppen. 24 x 37 x 3 mm, Aluminium eloxiert, gebohrt

stair nosing 24 x 37 x 3 mm, aluminium anodized, drilled

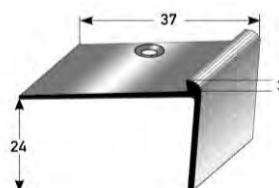

| | | | |
|-----------------------------|---------------------|-------------------------|-----------------------|
| silver | 1,0 | 35560-1 | 9,98 |
| silver | 2,7 | 35520-5 | 27,02 |
| goldfarbig, gold | 1,0 | 35570-0 | 10,50 |
| goldfarbig, gold | 2,7 | 35530-4 | 28,34 |
| bronzef. Hell,bronze light | 1,0 | 35580-9 | 11,72 |
| bronzef. hell bronze light | 2,7 | 35540-3 | 31,58 |
| bronzef. dunkel bronze dark | 1,0 | 35590-8 | 11,72 |
| bronzef. dunkel bronze dark | 2,7 | 35550-2 | 31,58 |

| | |
|-------------------------|-----------------------|
| 35561-8 | 10,80 |
| 35521-2 | 29,20 |
| 35571-7 | 11,26 |
| 35531-1 | 30,54 |
| 35581-6 | 12,50 |
| 35541-0 | 33,80 |
| 35591-5 | 12,50 |
| 35551-9 | 33,80 |



| | | |
|---|---------------------------|----------------------|
| Befestigungsschenkel ausklinken attachment flanges notched | Art./ref. | €/m |
| | 22240-8 | 5,72 |
| Befestigungsschenkel ausklinken und biegen attachment flanges notched and bent | auf Anfrage on reqUest | |

1. WINKELPROFILE + TREPPENKANTEN AUS ALUMINIUM + MESSING / 1. ANGLE EDGES + STAIR NOSINGS ALU + BRASS

Andere Eloxalfarben siehe Abschnitt 6, Lieferzeit 14 Tage/ other anodized colours see section 6, delivery time 14 days

| Profi-Pack à 10 StUeck im Bund | | | |
|--------------------------------|-----------|-----------|-------------|
| professional packing à 10 pcs. | | | |
| Farbe/colour | L / l (m) | Art./ref. | €/Stk./pcs. |

| SB-Pack incl. Schr./DUebel; VE 20 Stk. | |
|---|-------------|
| self-service-pack with screws/dowels; à 20 pcs. | |
| Art./ref. | €/Stk./pcs. |

341 Treppenkante 40 x 40 x 3 mm, Aluminium eloxiert, gebohrt

stair nosing 40 x 40 x 3 mm, aluminium anodized, drilled

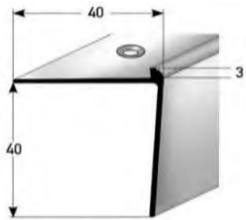

| | | | |
|-----------------------------|---------------------|-------------------------|-----------------------|
| silver | 1.0 | 65750-7 | 10,88 |
| silver | 2.7 | 65752-1 | 29,44 |
| goldfarbig, gold | 1.0 | 65754-5 | 11,32 |
| goldfarbig, gold | 2.7 | 65756-9 | 30,60 |
| bronzef. Hell,bronze light | 1.0 | 65758-3 | 13,50 |
| bronzef. hell bronze light | 2.7 | 65760-6 | 36,42 |
| bronzef. dunkel bronze dark | 1.0 | 65762-0 | 13,50 |
| bronzef. dunkel bronze dark | 2.7 | 65764-4 | 36,42 |

| | |
|-------------------------|-----------------------|
| 65770-5 | 11,66 |
| 65772-9 | 31,74 |
| 65774-3 | 12,10 |
| 65776-7 | 32,92 |
| 65778-1 | 14,26 |
| 65780-4 | 38,72 |
| 65782-8 | 14,26 |
| 65784-2 | 38,72 |

334 Treppenkante 10 x 37 x 5 mm, Aluminium eloxiert, gebohrt

stair nosing 10 x 37 x 5 mm, aluminium anodized, drilled

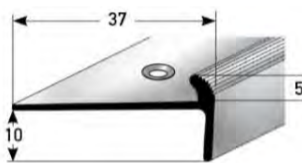

| | | | |
|-----------------------------|---------------------|-------------------------|-----------------------|
| silver | 1.0 | 65350-9 | 10,04 |
| silver | 2.7 | 65352-3 | 27,20 |
| goldfarbig, gold | 1.0 | 65360-8 | 10,58 |
| goldfarbig, gold | 2.7 | 65362-2 | 28,54 |
| bronzef. Hell,bronze light | 1.0 | 65370-7 | 11,76 |
| bronzef. hell bronze light | 2.7 | 65372-1 | 31,78 |
| bronzef. dunkel bronze dark | 1.0 | 65380-6 | 11,76 |
| bronzef. dunkel bronze dark | 2.7 | 65382-0 | 31,78 |

| | |
|-------------------------|-----------------------|
| 65354-7 | 10,8 |
| 65356-1 | 29,6 |
| 65364-6 | 11,36 |
| 65366-0 | 30,92 |
| 65374-5 | 12,56 |
| 65376-9 | 34,18 |
| 65384-4 | 12,56 |
| 65386-8 | 34,18 |

267 Treppenkante 24 x 37 x 5 mm, Aluminium eloxiert, gebohrt

stair nosing 24 x 37 x 5 mm, aluminium anodized, drilled

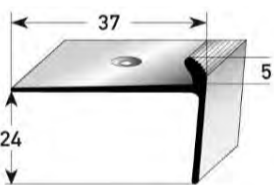

| | | | |
|-----------------------------|---------------------|-------------------------|-----------------------|
| silver | 1.0 | 46522-5 | 10,18 |
| silver | 2.7 | 46520-1 | 27,44 |
| goldfarbig, gold | 1.0 | 46532-4 | 10,68 |
| goldfarbig, gold | 2.7 | 46530-0 | 28,82 |
| bronzef. Hell,bronze light | 1.0 | 46542-3 | 11,88 |
| bronzef. hell bronze light | 2.7 | 46540-9 | 32,10 |
| bronzef. dunkel bronze dark | 1.0 | 46552-2 | 11,88 |
| bronzef. dunkel bronze dark | 2.7 | 46550-8 | 32,10 |

| | |
|-------------------------|-----------------------|
| 46526-3 | 10,98 |
| 46524-9 | 29,86 |
| 46536-2 | 11,48 |
| 46534-8 | 31,26 |
| 46546-1 | 12,70 |
| 46544-7 | 34,54 |
| 46556-0 | 12,70 |
| 46554-6 | 34,54 |

340 Treppenkante 40 x 40 x 5 mm, Aluminium eloxiert, gebohrt

stair nosing 40 x 40 x 5 mm, aluminium anodized, drilled

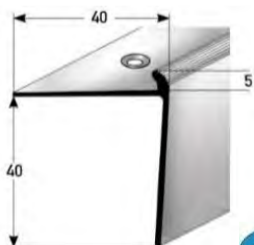

| | | | |
|-----------------------------|---------------------|-------------------------|-----------------------|
| silver | 1.0 | 65708-8 | 11,16 |
| silver | 2.7 | 65710-1 | 30,12 |
| goldfarbig, gold | 1.0 | 65712-5 | 11,62 |
| goldfarbig, gold | 2.7 | 65714-9 | 31,38 |
| bronzef. Hell,bronze light | 1.0 | 65716-3 | 13,82 |
| bronzef. hell bronze light | 2.7 | 65718-7 | 37,32 |
| bronzef. dunkel bronze dark | 1.0 | 65720-0 | 13,82 |
| bronzef. dunkel bronze dark | 2.7 | 65722-4 | 37,32 |

| | |
|-------------------------|-----------------------|
| 65728-6 | 11,94 |
| 65730-9 | 32,44 |
| 65732-3 | 12,40 |
| 65734-7 | 33,70 |
| 65736-1 | 14,58 |
| 65738-5 | 39,64 |
| 65740-8 | 14,58 |
| 65742-2 | 39,64 |



| |
|---|
| Befestigungsschenkel ausklinken attachment flanges notched |
| Befestigungsschenkel ausklinken und biegen attachment flanges notched and bent |

| Art./ref. | €/m |
|---------------------------|----------------------|
| 22240-8 | 5,72 |
| auf Anfrage on reqUest | |

1. WINKELPROFILE + TREPPENKANTEN AUS ALUMINIUM + MESSING / 1. ANGLE EDGES + STAIR NOSINGS ALU + BRASS

Andere Eloxalfarben siehe Abschnitt 6, Lieferzeit 14 Tage/ other anodized colours see section 6, delivery time 14 days

| Profi-Pack à 10 StUeck im Bund | | | |
|--------------------------------|-----------|-----------|-------------|
| professional packing à 10 pcs. | | | |
| Farbe/colour | L / l (m) | Art./ref. | €/Stk./pcs. |

| SB-Pack incl. Schr./ DUEbel; VE 20 Stk. | |
|--|-------------|
| self-service-pack with screws/ dowels; à 20 pcs. | |
| Art./ref. | €/Stk./pcs. |

333 Treppen. 10 x 37 x 7 mm, Alu. eloxiert, gebohrt

stair nosing 10 x 37 x 7 mm, aluminium anodized, drilled

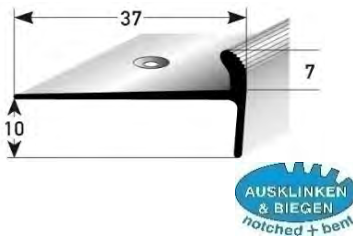

| | | | |
|-----------------------------|---------------------|-------------------------|-----------------------|
| silver | 1,0 | 65300-4 | 10,18 |
| silver | 2,7 | 65302-8 | 27,44 |
| goldfarbig, gold | 1,0 | 65310-3 | 10,68 |
| goldfarbig, gold | 2,7 | 65312-7 | 28,82 |
| bronzef. Hell, bronze light | 1,0 | 65320-2 | 11,88 |
| bronzef. hell bronze light | 2,7 | 65322-6 | 32,10 |
| bronzef. dunkel bronze dark | 1,0 | 65330-1 | 11,88 |
| bronzef. dunkel bronze dark | 2,7 | 65332-5 | 32,10 |

| | |
|-------------------------|-----------------------|
| 65304-2 | 10,98 |
| 65306-6 | 29,86 |
| 65314-1 | 11,48 |
| 65316-5 | 31,26 |
| 65324-0 | 12,70 |
| 65326-4 | 34,54 |
| 65334-9 | 12,70 |
| 65336-3 | 34,54 |



| Befestigungsschenkel ausklinken attachment flanges notched | |
|---|--|
| Befestigungsschenkel ausklinken und biegen attachment flanges notched and bent | |

| Art./ref. | €/m |
|---|-----|
| 22240-8 | |
| auf Anfrage on reqUest | |

| Wendbares Treppenseitenprofil aus Aluminium für 3 und 5 mm Beläge | |
|---|--|
| turnable stair side profiles out of aluminium, for 3 and 5mm flooring | |

| Profi-Pack à 10 StUeck im Bund | | | |
|--------------------------------|-----------|-----------|-------------|
| professional packing à 10 pcs. | | | |
| Farbe/colour | L / l (m) | Art./ref. | €/Stk./pcs. |

| SB-Pack; VE 20 Stk. | |
|------------------------------|-------------|
| self-service-pack; à 20 pcs. | |
| Art./ref. | €/Stk./pcs. |

496 wendb. Treppenseitenp. 3 / 5 mm, Alu. eloxiert, ungeb.

turnable stair side profile / 5 mm, aluminium anodized, undrilled

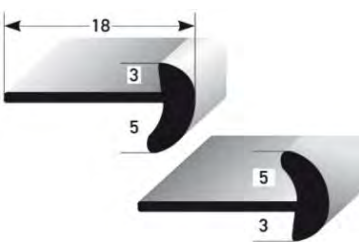

| | | | |
|-----------------------------|---------------------|-------------------------|-----------------------|
| silberfarbig ,silver | 2,7 | 71330-2 | 13,02 |
| goldfarbig, gold | 2,7 | 71332-6 | 13,24 |
| bronzef. Hell, bronze light | 2,7 | 71334-0 | 16,14 |
| bronzef. dunkel bronze dark | 2,7 | 71336-4 | 16,14 |

| | |
|-------------------------|-----------------------|
| 71338-8 | 13,62 |
| 71340-1 | 13,84 |
| 71342-5 | 16,74 |
| 71344-9 | 16,74 |

1. WINKELPROFILE + TREPPENKANTEN AUS ALUMINIUM + MESSING / 1. ANGLE EDGES + STAIR NOSINGS ALU + BRASS

Andere Eloxalfarben siehe
Abschnitt 6, Lieferzeit 14 Tage/
other anodized colours see section 6,
delivery time 14 days

| Treppeninnenecken aus Aluminium | | | |
|---------------------------------------|--|--|--|
| stair inside corners out of aluminium | | | |

| Profi-Pack à 10 StUeck im Bund | | | |
|--------------------------------|-----------|-----------|-------------|
| professional packing à 10 pcs. | | | |
| Farbe/colour | L / l (m) | Art./ref. | €/Stk./pcs. |

| SB-Pack incl. Schr./ DUebel; VE 20 Stk. | |
|---|-------------|
| self-service-pack with screws/ dowels; à 20 pcs. | |
| Art./ref. | €/Stk./pcs. |

369 Treppeninnenecke 3 mm, Aluminium eloxiert, gebohrt

stair inside corner 3 mm,
aluminium anodized, drilled

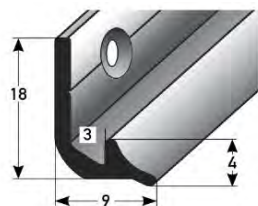

| | | | |
|-----------------------------|---------------------|-------------------------|-----------------------|
| silver | 1,0 | 66426-0 | 5,18 |
| silver | 2,7 | 66428-4 | 13,98 |
| goldfarbig, gold | 1,0 | 66430-7 | 5,32 |
| goldfarbig, gold | 2,7 | 66432-1 | 14,38 |
| bronzef. Hell,bronze light | 1,0 | 66434-5 | 5,84 |
| bronzef. hell bronze light | 2,7 | 66436-9 | 15,76 |
| bronzef. dunkel bronze dark | 1,0 | 66438-3 | 5,84 |
| bronzef. dunkel bronze dark | 2,7 | 66440-6 | 15,76 |

| | |
|-------------------------|-----------------------|
| 66427-7 | 5,98 |
| 66429-1 | 16,42 |
| 66431-4 | 6,14 |
| 66433-8 | 16,80 |
| 66435-2 | 6,66 |
| 66437-6 | 18,22 |
| 66439-0 | 6,66 |
| 66441-3 | 18,22 |

370 Treppeninnenecke 5 mm, Aluminium eloxiert, gebohrt

stair inside corner 5 mm,
aluminium anodized, drilled

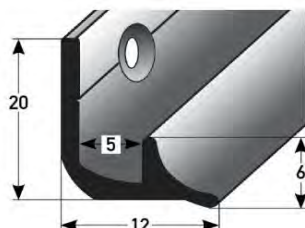

| | | | |
|-----------------------------|---------------------|-------------------------|-----------------------|
| silver | 1,0 | 66444-4 | 5,92 |
| silver | 2,7 | 66446-8 | 15,98 |
| goldfarbig, gold | 1,0 | 66448-2 | 6,10 |
| goldfarbig, gold | 2,7 | 66450-5 | 16,46 |
| bronzef. Hell,bronze light | 1,0 | 66452-9 | 6,58 |
| bronzef. hell bronze light | 2,7 | 66454-3 | 17,78 |
| bronzef. dunkel bronze dark | 1,0 | 66456-7 | 6,58 |
| bronzef. dunkel bronze dark | 2,7 | 66458-1 | 17,78 |

| | |
|-------------------------|-----------------------|
| 66445-1 | 6,74 |
| 66447-5 | 18,42 |
| 66449-9 | 6,90 |
| 66451-2 | 18,90 |
| 66453-6 | 7,38 |
| 66455-0 | 20,20 |
| 66457-4 | 7,38 |
| 66459-8 | 20,20 |

Beispiel: Treppeninnenecke 5 mm,
Aluminium eloxiert, gebohrt,
siehe oben
example: stair inside corner 5 mm,
aluminium anodized, drilled,
see above



1. WINKELPROFILE + TREPPENKANTEN AUS ALUMINIUM + MESSING / 1. ANGLE EDGES + STAIR NOSINGS ALU + BRASS

205

| Profi-Pack à 10 StUeck im Bund | | | |
|--------------------------------|-----------|-----------|-------------|
| professional packing à 10 pcs. | | | |
| Farbe/colour | L / l (m) | Art./ref. | €/Stk./pcs. |

| SB-Pack incl. Schr./DUebel; VE 20 Stk. | |
|---|-------------|
| self-service-pack with screws/dowels; à 20 pcs. | |
| Art./ref. | €/Stk./pcs. |

Treppen. 10 x 30 x 1,2 mm, Messing pol.t, profil. geb.

stair nosing 10 x 30 x 1,2 mm, brass polished, fluted profile, drilled

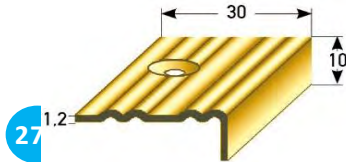

| | | | |
|---------------------------------------|---------------------|-------------------------|-----------------------|
| MESSING poliert brass polished | 1,0 | 61850-8 | 13,82 |
| MESSING poliert brass polished | 2,7 | 61870-6 | 37,32 |

| | |
|-------------------------|-----------------------|
| 61860-7 | 15,14 |
| 61880-5 | 40,76 |

Bitte fordern Sie unsere Pflegehinweise fUer Messingprofile an!
Please ask for our care tips for brass profiles!

Treppen. 20 x 40 x 1,5 mm, Messing matt, profil., geb.

stair nosing 20 x 40 x 1,5 mm, brass satin, fluted profile, drilled

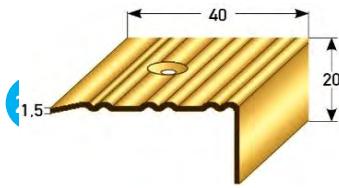

| | | | |
|---------------------------------|---------------------|-------------------------|-----------------------|
| MESSING matt brass satin | 1,0 | 46600-0 | 29,04 |
| MESSING matt brass satin | 2,0 | 46602-4 | 58,06 |

| | |
|-------------------------|-----------------------|
| 46604-8 | 29,82 |
| 46606-2 | 59,64 |

Bitte fordern Sie unsere Pflegehinweise fUer Messingprofile an!
Please ask for our care tips for brass profiles!

Treppen. 40 x 40 x 1,5 mm, Messing matt, profil. Riffelung, geb.

stair nosing 40 x 40 x 1,5 mm, brass satin, fluted profile, drilled

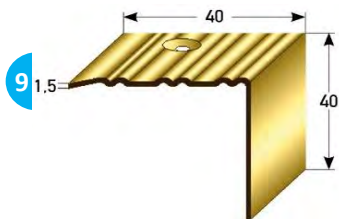

| | | | |
|---------------------------------|---------------------|-------------------------|-----------------------|
| MESSING matt brass satin | 1,0 | 46610-9 | 37,88 |
| MESSING matt brass satin | 2,0 | 46612-3 | 75,78 |

| | |
|-------------------------|-----------------------|
| 46614-7 | 38,68 |
| 46616-1 | 77,38 |

Bitte fordern Sie unsere Pflegehinweise fUer Messingprofile an!
Please ask for our care tips for brass profiles!

Treppenkante 15 x 35 mm, Messing poliert, gebohrt

stair nosing 15 x 35 mm, brass polished, drilled

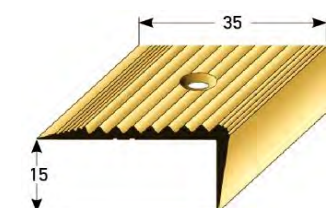

| | | | |
|---------------------------------------|---------------------|-------------------------|-----------------------|
| MESSING poliert brass polished | 1,0 | 28712-4 | 37,42 |
| MESSING poliert brass polished | 2,5 | 28710-0 | 93,56 |

| | |
|-------------------------|-----------------------|
| 28713-1 | 38,26 |
| 28711-7 | 96,06 |

Bitte fordern Sie unsere Pflegehinweise fUer Messingprofile an!
Please ask for our care tips for brass profiles!

1. WINKELPROFILE + TREPPENKANTEN AUS ALUMINIUM + MESSING / 1. ANGLE EDGES + STAIR NOSINGS ALU + BRASS

Andere Eloxalfarben siehe Abschnitt 6,
Lieferzeit 14 Tage/ other anodized
section 6, delivery
82 see
14 days

| Profi-Pack à 10 StUeck im Bund | | | |
|--------------------------------|-----------|-----------|-------------|
| professional packing à 10 pcs. | | | |
| Farbe/colour | L / l (m) | Art./ref. | €/Stk./pcs. |

| SB-Pack incl. Schr./ DUebel; VE 20 Stk. | |
|---|-------------|
| self-service-pack with screws/ dowels; à 20 pcs. | |
| Art./ref. | €/Stk./pcs. |

Kombi-Treppen. 27 x 40 mm, Alu. eloxiert, geb.

combination stair nosing
27 x 40 mm, aluminium anodized,
drilled

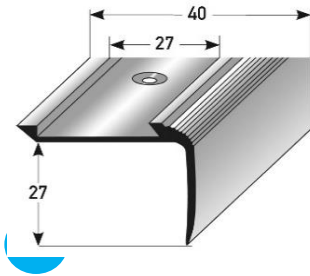

| | | | | | |
|-----------------------------|-----|-------------------------|-----------------------|-------------------------|-----------------------|
| silver | 1,0 | 07501-1 | 11,98 | | |
| silver | 2,5 | 07500-4 | 29,94 | 07502-8 | 32,10 |
| goldfarbig, gold | 1,0 | 07521-9 | 12,18 | | |
| goldfarbig, gold | 2,5 | 07520-2 | 30,54 | 07522-6 | 32,70 |
| bronzef. Hell,bronze light | 1,0 | 07541-7 | 13,86 | | |
| bronzef. hell bronze light | 2,5 | 07540-0 | 34,68 | 07542-4 | 36,92 |
| bronzef. dunkel bronze dark | 1,0 | 07561-5 | 13,86 | | |
| bronzef. dunkel bronze dark | 2,5 | 07560-8 | 34,68 | 07562-2 | 36,92 |

passend fUer Einlage 27 mm, siehe Seite 21
suitable for insert 27 mm, see page 21

Kombi-Treppen. 27 x 58 mm, Alu. eloxiert, geb.

combination stair nosing
27 x 58 mm, aluminium anodized,
drilled

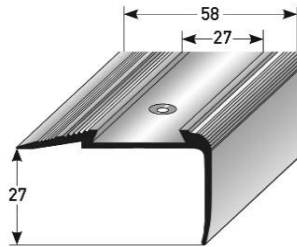

| | | | | | |
|-----------------------------|-----|-------------------------|-----------------------|-------------------------|-----------------------|
| silver | 1,0 | 07941-5 | 12,68 | | |
| silver | 2,5 | 07940-8 | 31,70 | 07942-2 | 33,74 |
| goldfarbig, gold | 1,0 | 07951-4 | 15,86 | | |
| goldfarbig, gold | 2,5 | 07950-7 | 39,68 | 07952-1 | 41,84 |
| bronzef. Hell,bronze light | 1,0 | 07961-3 | 17,56 | | |
| bronzef. hell bronze light | 2,5 | 07960-6 | 43,86 | 07962-0 | 46,06 |
| bronzef. dunkel bronze dark | 1,0 | 07971-2 | 17,56 | | |
| bronzef. dunkel bronze dark | 2,5 | 07970-4 | 43,86 | 07972-9 | 46,06 |

Aluminium mit abriebfester Spezialmaillierung, gebohrt/ aluminium enameled, hard wearing, drilled

147
stainless steel-enameled, colour - dark grey
stainless steel-enameled, colour - silver metallic

Farbton - dunkelgrau
Farbton - dunkelgrau

| | | | | |
|-----|-------------------------|------------------------|--|--|
| 1,0 | 40100-1 | 46,52 | | |
| 2,5 | 40110-0 | 116,28 | | |

| | |
|-------------------------|------------------------|
| 40101-8 | 47,78 |
| 40111-7 | 119,46 |

Farbton - dunkelgrau
Farbton - dunkelgrau

| | | | | |
|-----|-------------------------|------------------------|--|--|
| 1,0 | 40250-3 | 52,96 | | |
| 2,5 | 40251-0 | 132,38 | | |

| | |
|-------------------------|------------------------|
| 40252-7 | 54,24 |
| 40253-4 | 135,58 |

passend fUer Einlage 27 mm, siehe Seite 21
suitable for insert 27 mm, see page 21

Kombi-Treppen. 45 x 58 mm, Alu. eloxiert, geb.

combination stair nosing
45 x 58 mm, aluminium anodized,
drilled

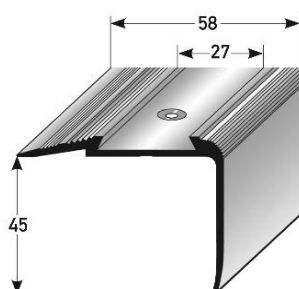

| | | | | | |
|-----------------------------|-----|-------------------------|-----------------------|-------------------------|-----------------------|
| silver | 1,0 | 42700-1 | 17,32 | | |
| silver | 2,7 | 42705-6 | 46,78 | 42710-0 | 49,00 |
| goldfarbig, gold | 1,0 | 42715-5 | 18,32 | | |
| goldfarbig, gold | 2,7 | 42720-9 | 49,36 | 42725-4 | 51,56 |
| bronzef. Hell,bronze light | 1,0 | 42730-8 | 20,20 | | |
| bronzef. hell bronze light | 2,7 | 42735-3 | 54,62 | 42740-7 | 56,76 |
| bronzef. dunkel bronze dark | 1,0 | 42745-2 | 20,20 | | |
| bronzef. dunkel bronze dark | 2,7 | 42750-6 | 54,62 | 42755-1 | 56,76 |

passend fUer Einlage 27 mm, siehe Seite 21
suitable for insert 27 mm, see page 21

1. WINKELPROFILE + TREPPENKANTEN AUS ALUMINIUM + MESSING / 1. ANGLE EDGES + STAIR NOSINGS ALU + BRASS

Andere Eloxalfarben siehe **Abschnitt 6, Lieferzeit 14 Tage/** other anodized colours see section 6, **delivery time 14 days**

| Profi-Pack à 10 StUeck im Bund | | | |
|--------------------------------|-----------|-----------|-------------|
| professional packing à 10 pcs. | | | |
| Farbe/colour | L / l (m) | Art./ref. | €/Stk./pcs. |

| SB-Pack incl. Schr./DUebel; VE 20 Stk. | |
|---|-------------|
| self-service-pack with screws/dowels; à 20 pcs. | |
| Art./ref. | €/Stk./pcs. |

146 Kombi-Treppen. 80 x 58 mm, Alu. eloxiert, gebohrt

combination stair nosing 80 x 58 mm, aluminium anodized, drilled

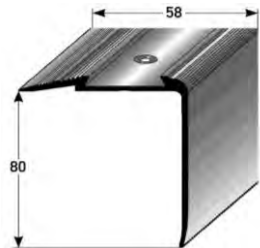

| | | | |
|-----------------------------|---------------------|-------------------------|-----------------------|
| silver | 1,0 | 42760-5 | 23,52 |
| silver | 2,7 | 42765-0 | 63,52 |
| goldfarbig, gold | 1,0 | 42775-9 | 24,82 |
| goldfarbig, gold | 2,7 | 42780-3 | 67,06 |
| bronzef. Hell, bronze light | 1,0 | 42790-2 | 27,44 |
| bronzef. hell bronze light | 2,7 | 42795-7 | 74,10 |
| bronzef. dunkel bronze dark | 1,0 | 42805-3 | 27,44 |
| bronzef. dunkel bronze dark | 2,7 | 42810-7 | 74,10 |

| | |
|-------------------------|-----------------------|
| 42770-4 | 65,68 |
| 42785-8 | 69,24 |
| 42800-8 | 76,26 |
| 42815-2 | 76,26 |

passend fUer Einlage 27 mm, siehe unten/ suitable for insert 27 mm, see below

Der lange Schenkel kann gekUerzt werden./ The long side can be shortened on reqUest.

121 -Einl. 27 mm, Weich-PVC

fUer Kombi-Treppenkanten Nr. 81, 82, 146 und 147

PVC-insert 27 mm for combination stair nosing no. 81, 82, 146 +147 made of soft PVC

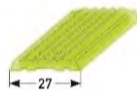

| | | eben/ smooth | | gerippt/ ribbed | |
|-----------------------------|---------------------|---|------------------------|-------------------------|-----------------------|
| | | | | | |
| grau/ grey | 1,0 | 55301-4 | 2,66/m | 56301-3 | 2,66 |
| schwarz/ black | 1,0 | 55302-1 | 2,66/m | 56302-0 | 2,66 |
| braun/ brown | 1,0 | 55303-8 | 2,66/m | 56303-7 | 2,66 |
| beige/ beige | 1,0 | 55304-5 | 2,66/m | 56304-4 | 2,66 |
| rot/ red | 1,0 | 55309-0 | 2,66/m | 56309-9 | 2,66 |
| blau/ blUe | 1,0 | 55300-7 | 2,66/m | 56300-6 | 2,66 |
| Extrem nachleuchtend | 1,0 | mit extremer Leuchtkraft with extreme luminosity | | 40135-3 | 18,08 |

fUer Zuschnitte erheben wir einen Arbeitsaufschlag von 15 %./ For cuttings we charge a labor surcharge of 15%.

Montagehinweis: Bei der Montage sind die Enden der Einlagen mit Montagekleber an der Schiene zu befestigen.

Installation advice: Fix the ends of the inserts at the profile with installation glUe.

92 Treppen. 15 x 36 mm, Alu. Elox., geb., fUer Einlage 12 mm,

stair nosing 15 x 36 mm, alu. anodized, drilled, suitable for insert 12 mm, see below

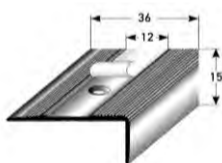

| Profi-Pack à 10 StUeck im Bund | | | |
|--------------------------------|---------------------|-------------------------|-----------------------|
| professional packing à 10 pcs. | | | |
| Farbe/colour | L / l (m) | Art./ref. | €/Stk./pcs. |
| silver | 1,0 | 07710-7 | 8,88 |
| silver | 2,7 | 07720-6 | 23,92 |
| goldfarbig, gold | 1,0 | 07730-5 | 9,18 |
| goldfarbig, gold | 2,7 | 07740-4 | 24,80 |
| bronzef. Hell, bronze light | 1,0 | 07750-3 | 10,52 |
| bronzef. hell bronze light | 2,7 | 07760-2 | 28,40 |
| bronzef. dunkel bronze dark | 1,0 | 07770-1 | 10,52 |
| bronzef. dunkel bronze dark | 2,7 | 07780-0 | 28,40 |

| SB-Pack incl. Schr./DUebel; VE 20 Stk. | |
|--|-----------------------|
| self-service-pack with screws/dowels; à 20 | |
| Art./ref. | €/Stk./pcs. |
| 07711-4 | 9,68 |
| 07721-3 | 26,08 |
| 07731-2 | 9,98 |
| 07741-1 | 26,98 |
| 07751-0 | 11,32 |
| 07761-9 | 30,64 |
| 07771-8 | 11,32 |
| 07781-7 | 30,64 |

485 Anti-Rutsch-Einlage 12 mm, gerippt,

selbstklebend, aus Weich-PVC, fUer Treppenkante Nr. 92 anti-slip insert 12 mm, ribbed, self-adhesive, soft PVC, for stair nosing no. 92

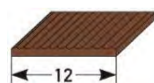

| Farbe/colour | L / l (m) | Art./ref. | € |
|----------------|-----------|-------------------------|----------------------|
| schwarz/ black | 1,0 | 07860-9 | 1,98 |
| grau/ grey | 1,0 | 07870-8 | 1,98 |
| braun/ brown | 1,0 | 07840-1 | 1,98 |
| beige/ beige | 1,0 | 07850-0 | 1,98 |

fUer Zuschnitte erheben wir einen Arbeitsaufschlag von 15 %.
For cuttings we charge a labor surcharge of 15%.

486 Easy-Clean-Einlage 12 mm, rau,

selbstklebend, fUer Treppenkante Nr. 92 easy-clean insert 12 mm, self-adhesive, rough, for stair nosing no. 92



| | | | |
|---------------------------|-----|-------------------------|----------------------|
| schwarz/ black | 1,0 | 71100-1 | 2,16 |
| grau/ grey | 1,0 | 71102-5 | 2,16 |
| gelb-schwarz yellow-black | 1,0 | 71104-9 | 2,30 |

fUer Zuschnitte erheben wir einen Arbeitsaufschlag von 15 %.
For cuttings we charge a labor surcharge of 15%.

Achtung! Verlegeanleitung fUer Einlagen beachten! Siehe Abschnitt 13./ Attention! Please follow the installation advice in section 13.

1. WINKELPROFILE + TREPPENKANTEN AUS ALUMINIUM + MESSING / 1. ANGLE EDGES + STAIR NOSINGS ALU + BRASS

Andere Eloxalfarben siehe Abschnitt 6, Lieferzeit 14 Tage/ other anodized colours see section 6, delivery time 14 days

| Profi-Pack à 10 StUeck im Bund | | | |
|--------------------------------|-----------|-----------|-------------|
| professional packing à 10 pcs. | | | |
| Farbe/colour | L / l (m) | Art./ref. | €/Stk./pcs. |

| SB-Pack incl. Schr./ DUebel; VE 20 Stk. | |
|--|-------------|
| self-service-pack with screws/ dowels; à 20 pcs. | |
| Art./ref. | €/Stk./pcs. |

373 Treppen. 39 x 48 mm, Alu. eloxiert, geb.

stair nosing 39 x 48 mm, aluminium anodized, drilled

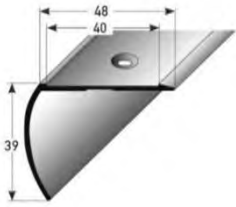

| | | | | | |
|-----------------------------|---------------------|-------------------------|-----------------------|-------------------------|-----------------------|
| silver | 1,0 | 66362-1 | 11,96 | | |
| silver | 2,7 | 66364-5 | 32,26 | 66366-9 | 34,68 |
| goldfarbig, gold | 1,0 | 66368-3 | 12,48 | | |
| goldfarbig, gold | 2,7 | 66370-6 | 33,70 | 66372-0 | 36,10 |
| bronzef. Hell,bronze light | 1,0 | 66374-4 | 14,20 | | |
| bronzef. hell bronze light | 2,7 | 66376-8 | 38,34 | 66378-2 | 40,76 |
| bronzef. dunkel bronze dark | 1,0 | 66380-5 | 14,20 | | |
| bronzef. dunkel bronze dark | 2,7 | 66382-9 | 38,34 | 66384-3 | 40,76 |

passend fUer Einlage 39 mm, siehe unten/ suitable for insert 39 mm, see below

374 Treppenkante 43 x 50 mm, Aluminium eloxiert, gebohrt

stair nosing 43 x 50 mm, aluminium anodized, drilled

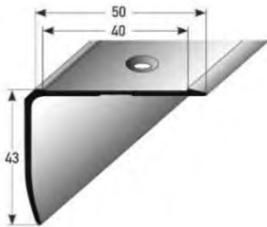

| | | | | | |
|-----------------------------|---------------------|-------------------------|-----------------------|-------------------------|-----------------------|
| silver | 1,0 | 66388-1 | 12,66 | | |
| silver | 2,7 | 66390-4 | 34,18 | 66392-8 | 36,58 |
| goldfarbig, gold | 1,0 | 66394-2 | 14,48 | | |
| goldfarbig, gold | 2,7 | 66396-6 | 39,10 | 66398-0 | 41,52 |
| bronzef. Hell,bronze light | 1,0 | 66400-0 | 14,98 | | |
| bronzef. hell bronze light | 2,7 | 66402-4 | 40,48 | 66404-8 | 42,90 |
| bronzef. dunkel bronze dark | 1,0 | 66406-2 | 14,98 | | |
| bronzef. dunkel bronze dark | 2,7 | 66408-6 | 40,48 | 66410-9 | 42,90 |

passend fUer Einlage 39 mm, siehe unten/ suitable for insert 39 mm, see below

390

Anti-Rutsch-Einlage 39 mm, gerippt, aus Weich-PVC, selbstklebend

anti-slip insert 39 mm, ribbed, self-adhesive,



| Farbe/colour | L / l (m) | Art./ref. | € |
|----------------|----------------------|-------------------------|----------------------|
| schwarz/ black | 1,00 | 66800-8 | 3,62 |
| grau/ grey | 1,00 | 66806-0 | 3,62 |
| braun/ brown | 1,00 | 66812-1 | 3,62 |
| beige/ beige | 1,00 | 66818-3 | 3,62 |

Easy-Clean-Einlage 39 mm, rau, selbstklebend

easy-clean insert 39 mm,



| | | | |
|---------------------------|----------------------|-------------------------|----------------------|
| schwarz/ black | 1,00 | 66416-1 | 2,58 |
| grau/ grey | 1,00 | 66414-7 | 2,58 |
| gelb-schwarz yellow-black | 1,00 | 66418-5 | 2,58 |

Anti-Rutsch-Einlage 39 mm, grobe Koernung K60, selbstklebend

anti-slip insert 39 mm,

self-adhesive

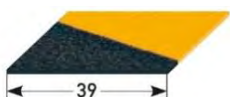

| | | | |
|---------------------------|----------------------|-------------------------|----------------------|
| schwarz/ black | 1,00 | 71110-0 | 2,58 |
| grau/ grey | 1,00 | 71112-4 | 2,58 |
| braun/ brown | 1,00 | 71114-8 | 2,58 |
| gelb-schwarz,yellow-black | 1,00 | 71116-2 | 3,06 |

passend fUer Uebergangprofil Nr. 412 & Treppenkanten Nr. 373/ 374/ 394-396
suitable for connecting profile no. 412 and stair nosing no. 373/ 374/ 394-396

FUer Zuschnitte erheben wir einen Arbeitsaufschlag von 15 %.
For cuttings we charge a labor surcharge of 15%.

1. WINKELPROFILE + TREPPENKANTEN AUS ALUMINIUM + MESSING / 1. ANGLE EDGES + STAIR NOSINGS ALU + BRASS

Andere Eloxalfarben siehe Abschnitt 6, Lieferzeit 14 Tage/ other anodized colours see section 6, delivery time 14 days

| Profi-Pack à 10 StUeck im Bund | | | |
|--------------------------------|-----------|-----------|-------------|
| professional packing à 10 pcs. | | | |
| Farbe/colour | L / l (m) | Art./ref. | €/Stk./pcs. |

| SB-Pack incl. Schr./ DUebel; VE 20 Stk. | |
|--|-------------|
| self-service-pack with screws/ dowels; à 20 pcs. | |
| Art./ref. | €/Stk./pcs. |

86 Treppenkante 28,5 x 53 mm, Aluminium eloxiert, gebohrt

stair nosing 28,5 x 53 mm, aluminium anodized, drilled

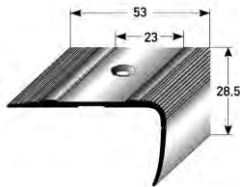

| | | | | | |
|-----------------------------|-----|---------|-------|---------|-------|
| silver | 1,0 | 35440-6 | 14,64 | | |
| silver | 2,7 | 35400-0 | 39,52 | 35401-7 | 41,72 |
| goldfarbig, gold | 1,0 | 35450-5 | 15,12 | | |
| goldfarbig, gold | 2,7 | 35410-9 | 40,78 | 35411-6 | 42,96 |
| bronzef. Hell,bronze light | 1,0 | 35460-4 | 17,18 | | |
| bronzef. hell bronze light | 2,7 | 35420-8 | 46,42 | 35421-5 | 48,62 |
| bronzef. dunkel bronze dark | 1,0 | 35470-3 | 17,18 | | |
| bronzef. dunkel bronze dark | 2,7 | 35430-7 | 46,42 | 35431-4 | 48,62 |

passend fUer Einlage 23 mm siehe unten/ suitable for insert 23 mm see below

80 Treppenkante 28,5 x 75 mm, Aluminium eloxiert, gebohrt

stair nosing 28,5 x 75 mm, aluminium anodized, drilled

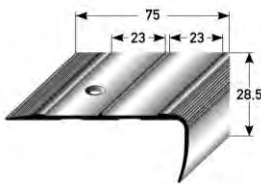

| | | | | | |
|-----------------------------|-----|---------|-------|---------|-------|
| silver | 1,0 | 39660-4 | 17,56 | | |
| silver | 2,7 | 39670-3 | 47,36 | 39671-0 | 49,54 |
| goldfarbig, gold | 1,0 | 39680-2 | 18,22 | | |
| goldfarbig, gold | 2,7 | 39690-1 | 49,12 | 39691-8 | 51,32 |
| bronzef. Hell,bronze light | 1,0 | 39700-7 | 20,36 | | |
| bronzef. hell bronze light | 2,7 | 39710-6 | 55,04 | 39711-3 | 57,22 |
| bronzef. dunkel bronze dark | 1,0 | 39720-5 | 20,36 | | |
| bronzef. dunkel bronze dark | 2,7 | 39730-4 | 55,04 | 39731-1 | 57,22 |

doppelte Menge der Einlage 23 mm berUecksichtigen/ double number of inserts 23 mm required

488 Anti-Rutsch-Einlage 23 mm, gerippt, aus Weich-PVC, selbstklebend

anti-slip insert 23 mm, ribbed, self-adhesive, soft PVC

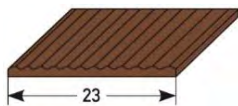

| Farbe/colour | L / l (m) | Art./ref. | € |
|----------------|-----------|-----------|------|
| schwarz/ black | 1,00 | 35490-1 | 2,00 |
| grau/ grey | 1,00 | 35480-2 | 2,00 |
| braun/ brown | 1,00 | 35500-7 | 2,00 |
| beige/ beige | 1,00 | 35510-6 | 2,00 |

fUer Treppenkanten Nr. 80 + 86
for stair nosings no. 80 + 86

489 Easy-Clean-Einlage 23 mm, rau, selbstklebend

easy-clean insert 23 mm, self-adhesive, rough



| | | | |
|---------------------------|------|---------|------|
| schwarz/ black | 1,00 | 71122-3 | 2,36 |
| grau/ grey | 1,00 | 71124-7 | 2,36 |
| gelb-schwarz yellow-black | 1,00 | 71126-1 | 2,60 |

fUer Treppenkanten Nr. 80 + 86
for stair nosings no. 80 + 86

490 Anti-Rutsch-Einlage 23 mm, grobe Körnung K60, selbstklebend,

anti-slip insert 23 mm, coarse grain K60, adhesive

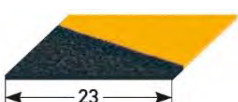

| | | | |
|----------------------------|------|---------|------|
| schwarz/ black | 1,00 | 71132-2 | 2,36 |
| grau/ grey | 1,00 | 71134-6 | 2,36 |
| braun/ brown | 1,00 | 71136-0 | 2,36 |
| gelb-schwarz ,yellow-black | 1,00 | 71138-4 | 2,60 |

fUer Treppenkanten Nr. 80 + 86
for stair nosings no. 80 + 86

FUer Zuschnitte erheben wir einen Arbeitsaufschlag von 15 %.
For cuttings we charge a labor surcharge of 15%.

Achtung! Verlegeanleitung fUer Einlagen beachten!
Siehe Abschnitt 13.
Attention! Please follow the installation advice in section 13.

1. WINKELPROFILE + TREPPENKANTEN AUS ALUMINIUM + MESSING / 1. ANGLE EDGES + STAIR NOSINGS ALU + BRASS

Andere Eloxalfarben siehe Abschnitt 6, Lieferzeit 14 Tage/ other anodized colours section 6, delivery time 14 days

264

| Profi-Pack à 10 StUeck im Bund | | | |
|--------------------------------|-----------|-----------|-------------|
| professional packing à 10 pcs. | | | |
| Farbe/colour | L / l (m) | Art./ref. | €/Stk./pcs. |

| SB-Pack incl. Schr./ DÜbel; VE 20 Stk. | |
|--|-------------|
| self-service-pack with screws/ dowels; à 20 pcs. | |
| Art./ref. | €/Stk./pcs. |

Treppenkante 30 x 40 x 2 mm, Aluminium eloxiert, gebohrt

stair nosing 30 x 40 x 2 mm, aluminium anodized, drilled

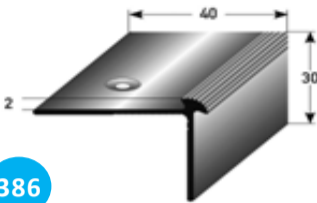

386



| | | | |
|-----------------------------|---------------------|-------------------------|-----------------------|
| silver | 1.0 | 46560-7 | 9.42 |
| silver | 2.7 | 46562-1 | 25.42 |
| goldfarbig, gold | 1.0 | 46570-6 | 9.78 |
| goldfarbig, gold | 2.7 | 46572-0 | 26.42 |
| bronzef. Hell,bronze light | 1.0 | 46580-5 | 11.38 |
| bronzef. hell bronze light | 2.7 | 46582-9 | 30.72 |
| bronzef. dunkel bronze dark | 1.0 | 46590-4 | 11.38 |
| bronzef. dunkel bronze dark | 2.7 | 46592-8 | 30.72 |

| | |
|-------------------------|-----------------------|
| 46564-5 | 10.24 |
| 46566-9 | 27.84 |
| 46574-4 | 10.60 |
| 46576-8 | 28.82 |
| 46584-3 | 12.16 |
| 46586-7 | 33.14 |
| 46594-2 | 12.16 |
| 46596-6 | 33.14 |

Treppenkante 30 x 40 x 2,5 mm, Aluminium eloxiert, gebohrt

stair nosing 30 x 40 x 2,5 mm, aluminium anodized, drilled

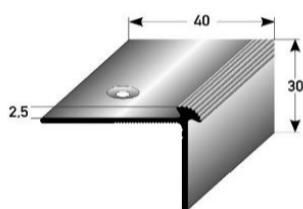

| | | | |
|-----------------------------|---------------------|-------------------------|-----------------------|
| silver | 1.0 | 66700-1 | 9.70 |
| silver | 2.7 | 66702-5 | 26.14 |
| goldfarbig, gold | 1.0 | 66704-9 | 10.96 |
| goldfarbig, gold | 2.7 | 66706-3 | 27.08 |
| bronzef. Hell,bronze light | 1.0 | 66708-7 | 11.66 |
| bronzef. hell bronze light | 2.7 | 66710-0 | 31.50 |
| bronzef. dunkel bronze dark | 1.0 | 66712-4 | 11.66 |
| bronzef. dunkel bronze dark | 2.7 | 66714-8 | 31.50 |

| | |
|-------------------------|-----------------------|
| 66724-7 | 10.46 |
| 66726-1 | 28.54 |
| 66728-5 | 11.74 |
| 66730-8 | 29.48 |
| 66732-2 | 12.46 |
| 66734-6 | 33.86 |
| 66736-0 | 12.46 |
| 66738-4 | 33.86 |

Treppenkante 30 x 40 x 3 mm, Aluminium eloxiert, gebohrt

stair nosing 30 x 40 x 3 mm, aluminium anodized, drilled

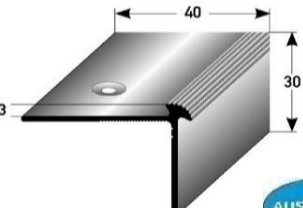

135



| | | | |
|-----------------------------|---------------------|-------------------------|-----------------------|
| silver | 1.0 | 41340-0 | 11.08 |
| silver | 2.7 | 41350-9 | 29.80 |
| goldfarbig, gold | 1.0 | 41360-8 | 11.48 |
| goldfarbig, gold | 2.7 | 41370-7 | 31.02 |
| bronzef. Hell,bronze light | 1.0 | 41380-6 | 12.54 |
| bronzef. hell bronze light | 2.7 | 41390-5 | 33.82 |
| bronzef. dunkel bronze dark | 1.0 | 41400-1 | 12.54 |
| bronzef. dunkel bronze dark | 2.7 | 41410-0 | 33.82 |

| | |
|-------------------------|-----------------------|
| 41341-7 | 11.86 |
| 41351-6 | 32.04 |
| 41361-5 | 12.34 |
| 41371-4 | 33.28 |
| 41381-3 | 13.38 |
| 41391-2 | 36.06 |
| 41401-8 | 13.38 |
| 41411-7 | 36.06 |

Treppenkante 30 x 40 x 5 mm, Aluminium eloxiert, gebohrt

stair nosing 30 x 40 x 5 mm, aluminium anodized, drilled

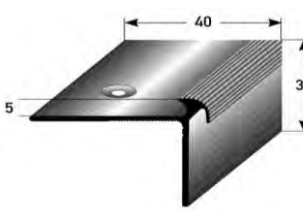

| | | | |
|-----------------------------|---------------------|-------------------------|-----------------------|
| silver | 1.0 | 41260-1 | 12.14 |
| silver | 2.7 | 41270-0 | 32.82 |
| goldfarbig, gold | 1.0 | 41280-9 | 12.68 |
| goldfarbig, gold | 2.7 | 41290-8 | 34.18 |
| bronzef. Hell,bronze light | 1.0 | 41300-4 | 13.82 |
| bronzef. hell bronze light | 2.7 | 41310-3 | 37.32 |
| bronzef. dunkel bronze dark | 1.0 | 41320-2 | 13.82 |
| bronzef. dunkel bronze dark | 2.7 | 41330-1 | 37.32 |

| | |
|-------------------------|-----------------------|
| 41261-8 | 12.94 |
| 41271-7 | 35.22 |
| 41281-6 | 13.46 |
| 41291-5 | 36.58 |
| 41301-1 | 14.62 |
| 41311-0 | 39.74 |
| 41321-9 | 14.62 |
| 41331-8 | 39.74 |



| | |
|---|--|
| Befestigungsschenkel ausklinken attachment flanges notched | |
| Befestigungsschenkel ausklinken und biegen attachment flanges notched and bent | |

| | |
|---------------------------|----------------------|
| Art./ref. | €/m |
| 22240-8 | 5.72 |
| auf Anfrage on reqUest | |

5. EINSCHUB- & ANSTOßPROFILE/ 5. INSERT PROFILES

Andere Eloxalfarben siehe
6, Lieferzeit 14 Tage/
other anodized
section 6,
time 14 days

Abschnitt
other anodized
section 6,

| Profi-Pack à 10 StUeck im Bund | | | |
|--------------------------------|-----------|-----------|-------------|
| professional packing à 10 pcs. | | | |
| Farbe/colour | L / l (m) | Art./ref. | €/Stk./pcs. |

| SB-Pack incl. Schr./ DUebel; VE 20 Stk. | |
|---|-------------|
| self-service-pack with screws/ dowels; à 20 pcs. | |
| Art./ref. | €/Stk./pcs. |

Treppenk. Doppelseinschub 3 mm, Alu. eloxiert, 2 x geb.

double insert stair nosing
3 mm, aluminium anodized,
2 x drilled

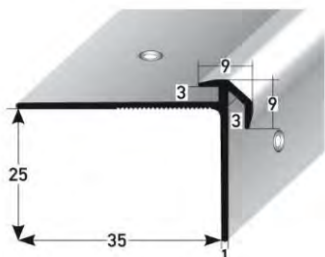

492

| | | | |
|--------------------------------|---------------------|-------------------------|-----------------------|
| silver | 1.0 | 71144-5 | 10.46 |
| silver | 2.7 | 71146-9 | 28.24 |
| goldfarbig, gold | 1.0 | 71148-3 | 10.90 |
| goldfarbig, gold | 2.7 | 71150-6 | 29.44 |
| bronzef. Hell,bronze light | 1.0 | 71152-0 | 12.82 |
| bronzef. hell bronze light | 2.7 | 71154-4 | 34.62 |
| bronzef. dunkel bronze dark | 1.0 | 71156-8 | 12.82 |
| bronzef. dunkel bronze dark | 2.7 | 71158-2 | 34.62 |
| gold hell, gold light | 1.0 | 71160-5 | 10.90 |
| gold hell, gold light | 2.7 | 71162-9 | 29.44 |
| edelstahlf. stainl. steel col. | 1.0 | 71164-3 | 12.82 |
| edelstahlf. stainl. steel col. | 2.7 | 71166-7 | 34.62 |

| | |
|-------------------------|-----------------------|
| 71168-1 | 11.20 |
| 71170-4 | 30.46 |
| 71172-8 | 11.64 |
| 71174-2 | 32.68 |
| 71176-6 | 13.56 |
| 71178-0 | 36.84 |
| 71180-3 | 13.56 |
| 71182-7 | 36.84 |
| 71184-1 | 11.64 |
| 71186-5 | 31.66 |
| 71188-9 | 13.56 |
| 71190-2 | 36.84 |

Treppenk. Doppelseinschub 5 mm, Alu. eloxiert, 2 x geb.

double insert stair nosing
5 mm, aluminium anodized,
2 x drilled

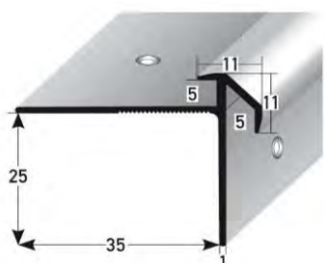

| | | | |
|--------------------------------|---------------------|-------------------------|-----------------------|
| silver | 1.0 | 71196-4 | 10.86 |
| silver | 2.7 | 71198-8 | 29.32 |
| goldfarbig, gold | 1.0 | 71200-8 | 11.40 |
| goldfarbig, gold | 2.7 | 71202-2 | 30.78 |
| bronzef. Hell,bronze light | 1.0 | 71204-6 | 13.26 |
| bronzef. hell bronze light | 2.7 | 71206-0 | 35.80 |
| bronzef. dunkel bronze dark | 1.0 | 71208-4 | 13.26 |
| bronzef. dunkel bronze dark | 2.7 | 71210-7 | 35.80 |
| gold hell, gold light | 1.0 | 71212-1 | 11.40 |
| gold hell, gold light | 2.7 | 71214-5 | 30.78 |
| edelstahlf. stainl. steel col. | 1.0 | 71216-9 | 13.26 |
| edelstahlf. stainl. steel col. | 2.7 | 71218-3 | 35.80 |

| | |
|-------------------------|-----------------------|
| 71220-6 | 11.60 |
| 71222-0 | 31.54 |
| 71224-4 | 12.14 |
| 71226-8 | 33.00 |
| 71228-2 | 14.00 |
| 71230-5 | 38.02 |
| 71232-9 | 14.00 |
| 71234-3 | 38.02 |
| 71236-7 | 12.14 |
| 71238-1 | 33.00 |
| 71240-4 | 14.00 |
| 71242-8 | 38.02 |

Technische Datenblaetter, Verlegehinweise, Materialbeschreibungen & Pflegehinweise erhalten Sie auf Anfrage./ Technical details, installation tips, material descriptions and care instructions are available on request.

2. TREPPENKANTEN EDELSTAHL

2. STAIR NOSINGS STAINLESS STEEL

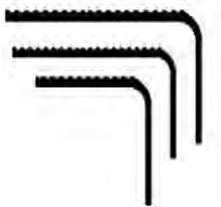
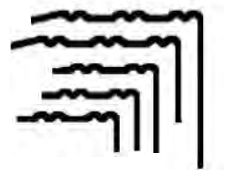
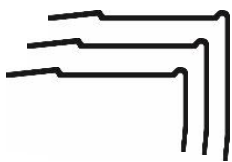

2. TREPPENKANTEN EDELSTAHL/ 2. STAIR NOSINGS STAINLESS STEEL

Edelstahlschrauben siehe Abschnitt 12/ stainless steel screws see section 12

394

Treppenk. 25 x 63 x 1,5 mm INOX PROTECT, Edelstahl matt, geb.

stair nosing 25 x 63 x 1,5 mm INOX PROTECT, stainless steel satin, drilled

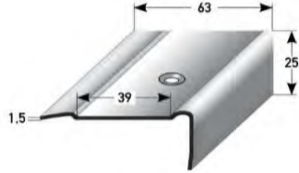

395

Treppenk. 35 x 63 x 1,5 mm INOX PROTECT, Edelstahl matt, geb.

stair nosing 35 x 63 x 1,5 mm INOX PROTECT, stainless steel satin, drilled

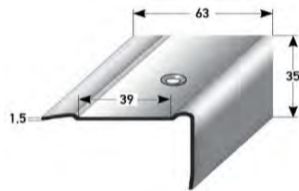

396

Treppenkanten 45 x 63 x 1,5 mm INOX PROTECT, Edelstahl matt, gebohrt

stair nosing 45 x 63 x 1,5 mm INOX PROTECT, stainless steel satin, drilled

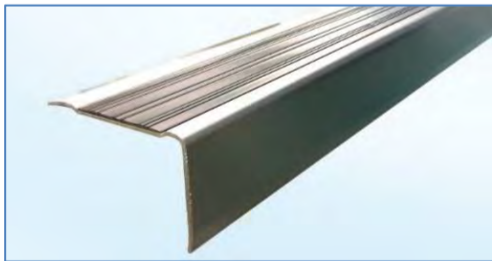
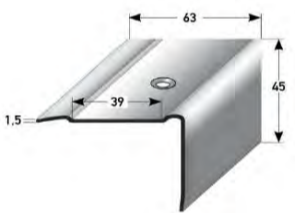

Treppenkante INOX PROTECT mit Einlage 39 mm, schwarz, gerippt (siehe oben bzw. Seite 22)
nosing INOX PROTECT with insert 39 mm, black, ribbed (see above and at page 22)

Edelstahl-Treppenkanten INOX PROTECT 39 mm zur Verlegung mit Einlage

stainless steel stair nosings for installation with insert 39 mm

| L / l (m) | VE/unit | Art./ref. | €/Stk./pcs. |
|----------------|-----------------------|-------------------------|------------------------|
| edelstahl matt | 1,0 m | 67000-1 | 41,24 |
| edelstahl matt | 2,5 m | 67002-5 | 103,12 |
| edelstahl matt | 3,0 m | 67004-9 | 123,72 |

fUer Verlegung mit Einlage 39 mm, siehe Seite 22
for installation with insert 39 mm, see page 22

| | | | |
|----------------|-----------------------|-------------------------|------------------------|
| edelstahl matt | 1,0 m | 67008-7 | 45,82 |
| edelstahl matt | 2,5 m | 67010-0 | 114,56 |
| edelstahl matt | 3,0 m | 67012-4 | 137,48 |

fUer Verlegung mit Einlage 39 mm, siehe Seite 22
for installation with insert 39 mm, see page 22

| | | | |
|----------------|-----------------------|-------------------------|------------------------|
| edelstahl matt | 1,0 m | 67016-2 | 50,40 |
| edelstahl matt | 2,5 m | 67018-6 | 126,02 |
| edelstahl matt | 3,0 m | 67020-9 | 151,22 |

fUer Verlegung mit Einlage 39 mm, siehe Seite 22
for installation with insert 39 mm, see page 22

3,0 m-Ware ist nur per Spedition lieferbar (gesonderte Transportkosten)
3,0 m profiles are only available per forwarding agency (separate transport costs)

Trennscheibe 115 x 1 mm Inox special, zum Trennen von Edelstahlprofilen

cutting disc 115 x 1 mm Inox special, suitable for cutting stainless steel profiles Trennscheibe 1mm



| VE/unit | Art./ref. | €/Stk./pcs. |
|---------|-------------------------|----------------------|
| 1 | 22246-0 | 4,52 |

kaum Gratbildung bzw. thermische Blaufaerbung
hardly any flashing and no discolouring

Faechersch. 115 x 22,2 mm, Koern. 60 zum Entgraten von Edelstahl

flap disc 115 x 22,2 mm, grain size 60, suitable for deburring stainless steel Faecherscheibe#e 22,2mm



| | | |
|---|-------------------------|----------------------|
| 1 | 22250-7 | 7,36 |
|---|-------------------------|----------------------|

2. TREPPENKANTEN EDELSTAHL/ 2. STAIR NOSINGS STAINLESS STEEL

Edelstahl-Einschubprofile matt gebürstet für Höhen von 2 mm bis 22 mm

insert profiles out of stainless steel for heights from 2 mm till 22 mm

| Koffernr./ case no. | AxBxCxD (mm) | L / l (m) | Art./ref. | €/Stk./pcs. |
|------------------------|--------------|-----------|-----------|-------------|
|------------------------|--------------|-----------|-----------|-------------|

Andere Abmaße auf
Anfrage/ other dimensions on
demand

Einschubprofil mit Nase, Edelstahl matt, gebohrt

nosed insert profile, stainless steel satin, drilled

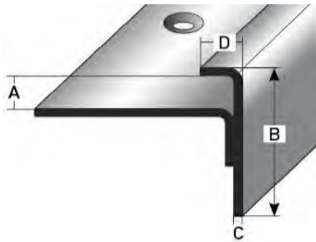

| | | | | |
|-----|--------------------|-------|---------|--------|
| 352 | 2 x 23 x 1,5 x 6 | 2,7 m | 60385-6 | 105,94 |
| 353 | 2,5 x 23 x 1,5 x 6 | 2,7 m | 60395-5 | 105,94 |
| 354 | 3 x 23 x 1,5 x 6 | 2,7 m | 60405-1 | 105,94 |
| 355 | 5 x 23 x 1,5 x 6 | 2,7 m | 60416-7 | 105,94 |

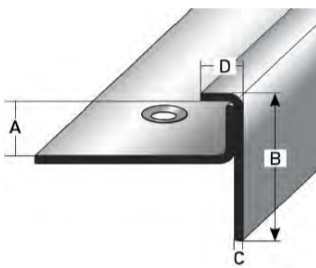

| | | | | |
|-----|-------------------|-------|---------|--------|
| 399 | 8 x 23 x 1,5 x 6 | 2,7 m | 67662-1 | 105,94 |
| 400 | 10 x 23 x 1,5 x 6 | 2,7 m | 67668-3 | 105,94 |
| 401 | 11 x 23 x 1,5 x 6 | 2,7 m | 67674-4 | 105,94 |
| 402 | 12 x 23 x 1,5 x 6 | 2,7 m | 67680-5 | 105,94 |
| 403 | 15 x 23 x 1,5 x 6 | 2,7 m | 67686-7 | 105,94 |

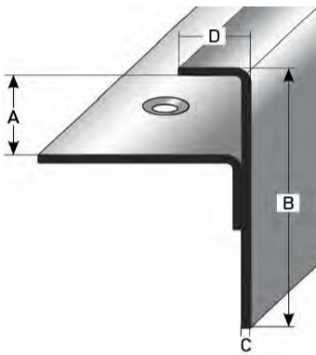

| | | | | |
|-----|---------------------|-------|---------|--------|
| 252 | 2,5 x 40 x 1,5 x 10 | 2,5 m | 60380-1 | 137,44 |
| 229 | 4,5 x 40 x 1,5 x 10 | 2,5 m | 60390-0 | 137,44 |
| 228 | 8 x 40 x 1,5 x 10 | 2,5 m | 60400-6 | 137,44 |
| 404 | 11 x 40 x 1,5 x 10 | 2,5 m | 60402-0 | 137,44 |
| 405 | 12 x 40 x 1,5 x 10 | 2,5 m | 60408-2 | 137,44 |
| 253 | 15 x 40 x 1,5 x 10 | 2,5 m | 60410-5 | 137,44 |
| 254 | 22 x 40 x 1,5 x 10 | 2,5 m | 60420-4 | 137,44 |

passende Edelstahlschrauben siehe Abschnitt 12/ suitable stainless steel screws see section 12

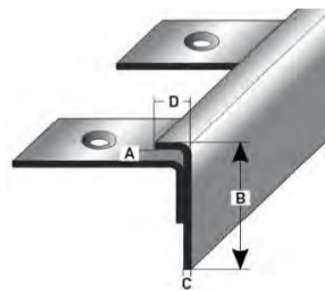

| | |
|-------------------------------|---------------------------|
| Profil biegen profile bent | auf Anfrage on request |
|-------------------------------|---------------------------|



Die Fertigung erfolgt auf Fixlängen, Verschnitt wird mit berechnet, ohne Zuschnittskosten.
Production takes place on fixed lengths, blended is charged with, without calculation of the cost of cutting.

2. TREPPENKANTEN EDELSTAHL/ 2. STAIR NOSINGS STAINLESS STEEL

Edelstahl-Treppeninnenecken matt gebürstet für Höhen von 2 mm bis 22 mm

Andere Abmaße auf Anfrage/ other dimensions on demand

stair inside corner out of stainless steel satin for heights from 2 mm till 22 mm

| Koffernr./ case no. | FÜer Belaghöhe = h in mm/ for flooring height = h in mm | L / l (m) | VE/unit | Art./ref. |
|------------------------|--|-----------|---------|-----------|
|------------------------|--|-----------|---------|-----------|

Treppeninnenecke Edelstahl matt, gebohrt

stair inside corner, stainless steel satin, drilled

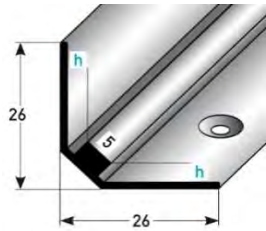

| | | | | |
|-----|----------|-----------------------|-------------------------|-----------------------|
| 367 | 2 - 3 mm | 1,0 m | 45621-6 | 34,84 |
| | 3 - 3 mm | 2,7 m | 45620-9 | 94,08 |
| 368 | 3 - 5 mm | 1,0 m | 45616-2 | 36,90 |
| | 4 - 5 mm | 2,7 m | 45615-5 | 99,64 |

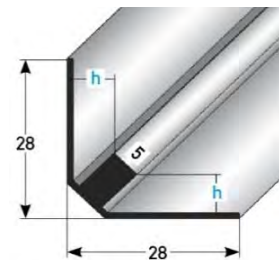

| | | | | |
|-----|-------|-----------------------|-------------------------|------------------------|
| 406 | 8 mm | 1,0 m | 67612-6 | 47,54 |
| | 9 mm | 2,7 m | 67614-0 | 128,36 |
| 407 | 10 mm | 1,0 m | 67620-1 | 47,54 |
| | 11 mm | 2,7 m | 67622-5 | 128,36 |
| 408 | 11 mm | 1,0 m | 67628-7 | 50,14 |
| | 12 mm | 2,7 m | 67630-0 | 135,34 |
| 409 | 12 mm | 1,0 m | 67636-2 | 50,14 |
| | 13 mm | 2,7 m | 67638-6 | 135,34 |

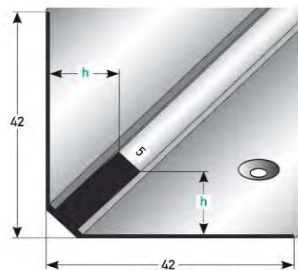

| | | | | |
|-----|-------|-----------------------|-------------------------|------------------------|
| 410 | 15 mm | 1,0 m | 67644-7 | 55,70 |
| | 16 mm | 2,7 m | 67646-1 | 150,40 |
| 411 | 22 mm | 1,0 m | 67652-2 | 57,82 |
| | 23 mm | 2,7 m | 67654-6 | 156,10 |

passende Edelstahlschrauben siehe Abschnitt 12

suitable stainless steel screws see section 12

Beispiel: Edelstahl-Einschubprofil mit Nase und Edelstahl-Treppeninnenecke (siehe oben und Seite 28) /

example: stainless steel insert profile with nose and stainless steel stair inside corner (see above and page 28)



Die Fertigung erfolgt auf Fixlängen, Verschnitt wird mit berechnet, ohne Zuschnittkosten.
Production takes place on fixed lengths, blended is charged with, without calculation of the cost of cutting.

2. TREPPENKANTEN EDELSTAHL/ 2. STAIR NOSINGS STAINLESS STEEL

Rutschhemmungsklasse: R10 PrUefzeugnis kann angefordert werden.

slip resistance class: R10 certificate can be reqUested.

Edelstahl-Treppenkante mit profilierter Riffelung, matt, 1,5 mm Materialdicke

stair nosing out of stainless steel satin, with fluted ruffle, 1,5 mm material thickness

passende Edelstahlschrauben
siehe Abschnitt 12/ suitable
stainless steel screws see section 12

Profi-Pack à 10 StUeck im Bund

professional packing à 10 pcs.

SB incl. DUEbel/ Edelstahlschrauben

self-service-pack with dowels/
stainless steel screws

| L / l (m) | VE/unit | Art./ref. | €/Stk./pcs. |
|-----------|---------|-----------|-------------|
|-----------|---------|-----------|-------------|

| Art./ref. | €/Stk./pcs. |
|-----------|-------------|
|-----------|-------------|

Edelstahl-Treppenkante 20 x 40 x 1,5 mm, profilierte Riffelung, matt, gebohrt

stainless steel stair nosing 20 x 40 x 1,5 mm, fluted profile, satin, drilled

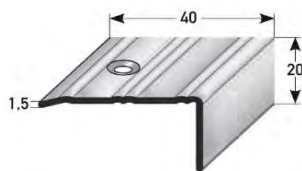

| | | | |
|-----------|---------------------|-------------------------|-----------------------|
| edelstahl | 1,0 | 61630-6 | 35,68 |
| edelstahl | 2,7 | 61640-5 | 96,40 |

| | |
|-------------------------|------------------------|
| 61635-1 | 37,80 |
| 61645-0 | 102,72 |

R10

154

Edelstahl-Treppenk. 40 x 40 x 1,5 mm, profilierte Riffelung, matt, geb.

stainless steel stair nosing 40 x 40 x 1,5 mm, fluted profile, satin, drilled

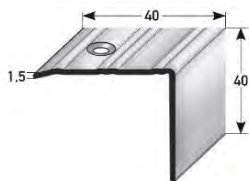

| | | | |
|-----------|---------------------|-------------------------|------------------------|
| edelstahl | 1,0 | 61690-0 | 47,60 |
| edelstahl | 2,7 | 61700-6 | 128,54 |

| | |
|-------------------------|------------------------|
| 61695-5 | 49,72 |
| 61705-1 | 134,84 |

R10

201

Edelstahl-Treppenk. 30 x 30 x 1,5 mm, profilierte Riffelung, matt, geb.

stainless steel stair nosing 30 x 30 x 1,5 mm, fluted profile, satin, drilled

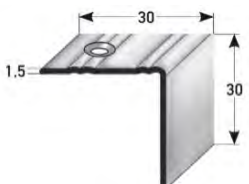

| | | | |
|-----------|---------------------|-------------------------|-----------------------|
| edelstahl | 1,0 | 61720-4 | 35,68 |
| edelstahl | 2,7 | 61730-3 | 96,40 |

| | |
|-------------------------|------------------------|
| 61725-9 | 37,80 |
| 61735-8 | 102,72 |

R10

202

Edelstahl-Treppenk. 20 x 30 x 1,5 mm, prof. Riffelung, matt, geb.

stainless steel stair nosing 20 x 30 x 1,5 mm, fluted profile, satin, drilled

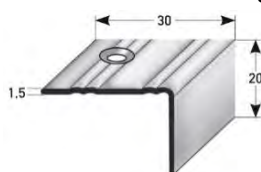

| | | | |
|-----------|---------------------|-------------------------|-----------------------|
| edelstahl | 1,0 | 61750-1 | 29,74 |
| edelstahl | 2,7 | 61760-0 | 80,32 |

| | |
|-------------------------|-----------------------|
| 61755-6 | 31,84 |
| 61765-5 | 86,64 |

R10

203

Edelstahl-Treppenk. 10 x 30 x 1,5 mm, prof. Riffelung, matt, geb.

stainless steel stair nosing 10 x 30 x 1,5 mm, fluted profile, satin, drilled

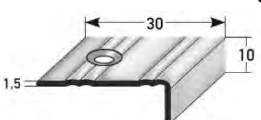

| | | | |
|-----------|---------------------|-------------------------|-----------------------|
| edelstahl | 1,0 | 61780-8 | 23,80 |
| edelstahl | 2,7 | 61790-7 | 64,26 |

| | |
|-------------------------|-----------------------|
| 61785-3 | 25,92 |
| 61795-2 | 70,54 |

R10

204

- ungebohrte Profile & Laengen bis 6,0 m auf Anfrage/ undrilled profiles and lengths up to 6,0 m on reqUest
- Werkstoff 1.4301 (V2A) / V4A auf Anfrage/ material 1.4301 (V2A) / V4A on reqUest

- Qualitaet zu waehlen ist die beste Art zu sparen -

choosing quality is the best way to save

2. TREPPENKANTEN EDELSTAHL/ 2. STAIR NOSINGS STAINLESS STEEL

Rutschhemmungsklasse: R10 PrUefzeugnis kann angefordert werden.

slip resistance class: R10 certificate can be requested.

Edelstahl-Treppenkante mit gefraester Riffelung - Zum Gegenstoßen von Bodenbelägen oder Beschichtungen bis 3mm, rutschhemmende Riffelung, Glattflaeche matt, gekantet, gebohrt mit Senkung

206

stainless steel stair nosing with milled fluting - for installation with carpets up to 3mm, antislip fluting, smooth edge satin, edged, countersunk drilled

| L / l (m) | VE/unit | Art./ref. | €/Stk./pcs. |
|-----------|---------|-----------|-------------|
|-----------|---------|-----------|-------------|

Edelstahl-Treppenkante 20 x 40 x 3 mm, gefraeste Riffelung, gekantet, gebohrt

stainless steel stair nosing 20 x 40 x 3 mm, milled fluting, edged, drilled

207

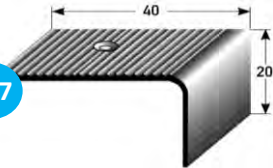

| | | | |
|-----------|---------------------|-------------------------|------------------------|
| edelstahl | 1,0 | 60500-3 | 145,24 |
| edelstahl | 2,5 | 60501-0 | 363,14 |

passende Edelstahlschrauben siehe
Abschnitt 12 suitable

R10

Edelstahl-Treppenkante 30 x 30 x 3 mm, gefraeste Riffelung, gekantet, gebohrt

stainless steel stair nosing 30 x 30 x 3 mm, milled fluting, edged, drilled

208

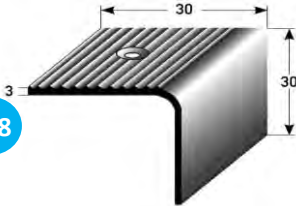

| | | | |
|-----------|---------------------|-------------------------|------------------------|
| edelstahl | 1,0 | 60510-2 | 145,24 |
| edelstahl | 2,5 | 60511-9 | 363,14 |

passende Edelstahlschrauben siehe
Abschnitt 12 suitable

R10

Edelstahl-Treppenkante 28 x 50 x 3 mm, gefraeste Riffelung, gekantet, gebohrt

stainless steel stair nosing 28 x 50 x 3 mm, milled fluting, edged, drilled

209

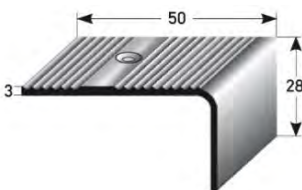

| | | | |
|-----------|---------------------|-------------------------|------------------------|
| edelstahl | 1,0 | 60520-1 | 193,66 |
| edelstahl | 2,5 | 60521-8 | 484,18 |

passende Edelstahlschrauben siehe
Abschnitt 12 suitable

R10



Kante im Auslauf anphasen (zum Aufsetzen auf Bodenbelag)

chamfering edges (to be installed on top of flooring)

| | | | |
|-------|-------------------|-------------------------|-----------------------|
| Kante | 1 | 22213-2 | 34,14 |
|-------|-------------------|-------------------------|-----------------------|

Treppenkante Edelstahl V4A gezogen

drawn stainless steel stair nosing V4A

438

Profi-Pack à 10 StUeck im Bund

professional packing à 10 pcs.

| L / l (m) | VE/unit | Art./ref. | €/Stk./pcs. |
|-----------|---------|-----------|-------------|
|-----------|---------|-----------|-------------|

**SB incl. DUebel/
Edelstahlschrauben**

self-service-pack with dowels/
stainless steel screws

| Art./ref. | €/Stk./pcs. |
|-----------|-------------|
|-----------|-------------|

Treppenkante 23 x 25 x 3,5 mm, Edelstahl V4A gezogen, gebohrt

drawn stainless steel stair nosing V4A 23 x 25 x 3,5 mm, drilled

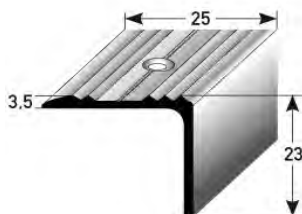

| | | |
|-----------|---------------------|------------------------|
| edelstahl | 1,0 | 102,20 |
| edelstahl | 2,5 | 255,50 |

| | |
|-------------------------|------------------------|
| 68256-1 | 104,32 |
| 68258-5 | 261,80 |

2. TREPPENKANTEN EDELSTAHL/ 2. STAIR NOSINGS STAINLESS STEEL

Rutschhemmungsklasse: R12 Prüfzeugnis kann angefordert werden.

slip resistance class: R12 certificate can be requested.

3,5 mm-Edelstahlschrauben,
siehe Abschnitt 12
3.5 mm stainless steel screws, see section 12

311

Edelstahl-Treppenkanten mit Praegelochung, matt gebürstet, gebohrt, mit Schutzfolie, VE 1 StUeck

stainless steel stair nosings with embossed punching, 1,5 mm material thickness, satin brushed, drilled, unit 1 pcs.

| Dimension (mm) | L / l (m) | Art./ref. | €/Stk./pcs. |
|----------------|-----------|-----------|-------------|
|----------------|-----------|-----------|-------------|

Treppenk. mit Praegelochung., Edelstahl matt, geb., mit Schutzf.

stair nosing 10 x 30 x 1,5 mm with embossed punching, stainless steel satin, drilled, with protective film

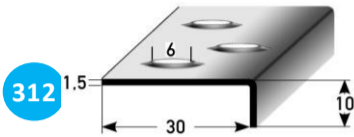

312

| | | | |
|---------------|-----------------------|-------------------------|-----------------------|
| 10 x 30 x 1,5 | 1,0 m | 65118-5 | 27,00 |
| 11 x 30 x 1,5 | 2,5 m | 65120-8 | 67,54 |
| 12 x 30 x 1,5 | 3,0 m | 65122-2 | 81,02 |

R12

Treppenkante 20 x 40 x 1,5 mm mit Praegelochung, Edelstahl matt, gebohrt, mit Schutzfolie

stair nosing 20 x 40 x 1,5 mm with embossed punching, stainless steel satin, drilled, with protective film

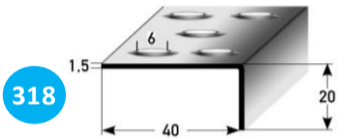

318

| | | | |
|---------------|-----------------------|-------------------------|------------------------|
| 20 x 40 x 1,5 | 1,0 m | 65128-4 | 44,38 |
| 21 x 40 x 1,5 | 2,5 m | 65130-7 | 110,92 |
| 22 x 40 x 1,5 | 3,0 m | 65132-1 | 133,10 |

R12

Treppenkante 25 x 60 x 1,5 mm mit Praegelochung, Edelstahl matt, gebohrt, mit Schutzfolie

stair nosing 25 x 60 x 1,5 mm with embossed punching, stainless steel satin, drilled, with protective film

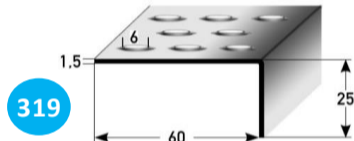

319

| | | | |
|---------------|-----------------------|-------------------------|------------------------|
| 25 x 60 x 1,5 | 1,0 m | 65158-1 | 66,54 |
| 26 x 60 x 1,5 | 2,5 m | 65160-4 | 166,40 |
| 27 x 60 x 1,5 | 3,0 m | 65162-8 | 199,68 |

R12

Treppenkante 25 x 80 x 1,5 mm mit Praegelochung, Edelstahl matt, gebohrt, mit Schutzfolie

stair nosing 25 x 80 x 1,5 mm with embossed punching, stainless steel satin, drilled, with protective film

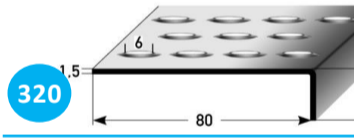

320

| | | | |
|---------------|-----------------------|-------------------------|------------------------|
| 25 x 80 x 1,5 | 1,0 m | 65168-0 | 88,76 |
| 26 x 80 x 1,5 | 2,5 m | 65170-3 | 221,86 |
| 27 x 80 x 1,5 | 3,0 m | 65172-7 | 266,26 |

R12

Treppenkante 50 x 80 x 1,5 mm mit Praegelochung, Edelstahl matt, gebohrt, mit Schutzfolie

stair nosing 50 x 80 x 1,5 mm with embossed punching, stainless steel satin, drilled, with protective film

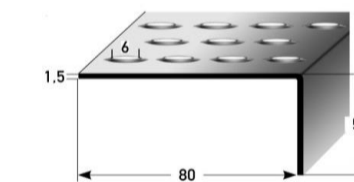

320

| | | | |
|---------------|-----------------------|-------------------------|------------------------|
| 50 x 80 x 1,5 | 1,0 m | 65178-9 | 109,90 |
| 51 x 80 x 1,5 | 2,5 m | 65180-2 | 274,72 |
| 52 x 80 x 1,5 | 3,0 m | 65182-6 | 329,64 |

R12

Lieferzeit nach vorheriger Absprache
delivery time by prior arrangement

Alternativ mit Noppenprägung (geschlossene Oberfläche) auf Anfrage erhältlich.

Alternatively available with knobs embossing (closed surface) on request.

3,0 m-Ware ist nur per Spedition lieferbar (gesonderte Transportkosten)
3,0 m profiles are only available per forwarding agency (separate transport costs)

2. TREPPENKANTEN EDELSTAHL/ 2. STAIR NOSINGS STAINLESS STEEL

Rutschhemmungsklasse: R12 PrUefzeugnis kann angefordert werden.

slip resistance class: R12 certificate can be reqUested.

Edelstahl-Treppenkanten mit Praegelochung und ANKER, matt gebUerstet, mit Schutzfolie, VE 1 StUeck, mit Stahlanker zum Einbetten in Beton

328

stainless steel stair nosings with embossed punching and anchor bolt, satin brushed, unit 1 pcs., with steel anchors for embedding in concrete

| Dimension (mm) | L / l (m) | Art./ref. | €/Stk./pcs. |
|----------------|-----------|-----------|-------------|
|----------------|-----------|-----------|-------------|

Treppenkante mit Praegelochung und ANKER, Edelstahl matt

stair nosing 10 x 30 x 1,5 mm with embossed punching + anchor, stainless steel satin

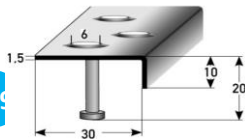

329

| | | | |
|---------------|-----------------------|-------------------------|------------------------|
| 10 x 30 x 1,5 | 1,0 m | 65188-8 | 42,40 |
| 11 x 30 x 1,5 | 2,5 m | 65190-1 | 106,06 |
| 12 x 30 x 1,5 | 3,0 m | 65192-5 | 127,24 |

R12

5 Bolzen/ LaufMeter Preis pro StUeck à ø 6 mm und 20 mm Laenge

5 anchor bolt/ running Meter Preis pro StUeck à ø 6 mm and 20 mm length

Treppenkante mm mit Praegelochung und ANKER, Edelstahl matt

stair nosing 20 x 40 x 1,5 mm with embossed punching + anchor, stainless steel satin

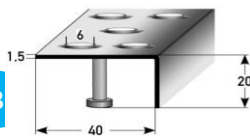

33

| | | | |
|---------------|-----------------------|-------------------------|------------------------|
| 20 x 40 x 1,5 | 1,0 m | 65198-7 | 59,78 |
| 21 x 40 x 1,5 | 2,5 m | 65200-7 | 149,44 |
| 22 x 40 x 1,5 | 3,0 m | 65202-1 | 179,32 |

R12

5 Bolzen/ LaufMeter Preis pro StUeck à ø 6 mm und 20 mm Laenge

5 anchor bolt/ running Meter Preis pro StUeck à ø 6 mm and 20 mm length

Treppenkante mm mit Praegelochung und ANKER, Edelstahl matt

stair nosing 25 x 60 x 1,5 mm with embossed punching + anchor, stainless steel satin

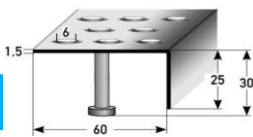

33

| | | | |
|---------------|-----------------------|-------------------------|------------------------|
| 25 x 60 x 1,5 | 1,0 m | 65208-3 | 81,94 |
| 26 x 60 x 1,5 | 2,5 m | 65210-6 | 204,90 |
| 27 x 60 x 1,5 | 3,0 m | 65212-0 | 245,86 |

R12

5 Bolzen/ LaufMeter Preis pro StUeck à ø 6 mm und 30 mm Laenge

5 anchor bolt/ running Meter Preis pro StUeck à ø 6 mm and 30 mm length

Treppenkante mit Praegelochung und ANKER, Edelstahl matt

stair nosing 25 x 80 x 1,5 mm with embossed punching + anchor, stainless steel satin

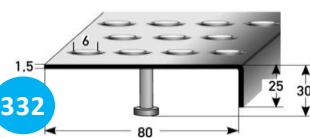

332

| | | | |
|---------------|-----------------------|-------------------------|------------------------|
| 25 x 80 x 1,5 | 1,0 m | 65238-0 | 104,16 |
| 26 x 80 x 1,5 | 2,5 m | 65240-3 | 260,42 |
| 27 x 80 x 1,5 | 3,0 m | 65242-7 | 312,50 |

R12

5 Bolzen/ LaufMeter Preis pro StUeck à ø 6 mm und 30 mm Laenge

5 anchor bolt/ running Meter Preis pro StUeck à ø 6 mm and 30 mm length

Treppenkante mit Praegelochung und ANKER, Edelstahl matt

stair nosing 50 x 80 x 1,5 mm with embossed punching + anchor, stainless steel satin

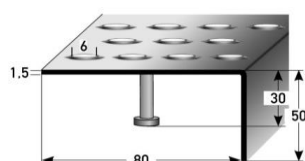

| | | | |
|---------------|-----------------------|-------------------------|------------------------|
| 50 x 80 x 1,5 | 1,0 m | 65248-9 | 125,30 |
| 51 x 80 x 1,5 | 2,5 m | 65250-2 | 313,24 |
| 52 x 80 x 1,5 | 3,0 m | 65252-6 | 375,88 |

R12

5 Bolzen/ LaufMeter Preis pro StUeck à ø 6 mm und 30 mm Laenge

5 anchor bolt/ running Meter Preis pro StUeck à ø 6 mm and 30 mm length

Lieferzeit nach vorheriger Absprache/ delivery time by prior arrangement

Alternativ mit Noppenpraegung auf Anfrage erhaeltlich./ Alternatively available with knobs embossing on reqUest.

3,0 m-Ware ist nur per Spedition lieferbar (gesonderte Transportkosten)
3,0 m profiles are only available per forwarding agency (separate transport costs)

4. UeBERGANGSPROFILE AUS ALUMINIUM, EDELSTAHL UND MESSING 4. CONNECTING PROFILES OUT OF ALUMINIUM + STAINLESS STEEL + BRASS



4. UEBERGANGSPROFILE/ 4. CONNECTING PROFILES

Seitlich gebohrt, ungebohrt oder als Flachstreifen auf Anfrage erhaeltlich!
Laterally drilled, undrilled or as flat profile available on demand!

| 142 Profi-Pack à 10 StUeck im Bund | | | | |
|------------------------------------|-------------|-----------|-----------|-------------|
| professional packing à 10 pcs. | | | | |
| Dicke + Befestigung fixing | thickness + | L / l (m) | Art./ref. | €/Stk./pcs. |

| SB-Pack incl. Schr./ DUebel; VE 20 Stk. | |
|---|-------------|
| self-service-pack with screws/ dowels; à 20 pcs. | |
| Art./ref. | €/Stk./pcs. |

Uebergangspr. 20 mm, Messing pol.

connecting profile 20 mm, brass polished, with **143** active film

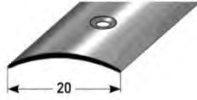

| 1,2 mm | 1,2mm gebohrt , drilled | 0,9 | 41200-7 | 5,68 |
|--------|-------------------------|-----|---------|-------|
| | | 1,0 | 41210-6 | 6,30 |
| | | 2,7 | 41220-5 | 17,02 |

| | |
|---------|-------|
| 41201-4 | 6,54 |
| 41211-3 | 7,28 |
| 41221-2 | 19,62 |

Uebergangsp. 20 mm, Edelstahl pol.

connecting profile 20 mm, stainless steel polished, with protective film

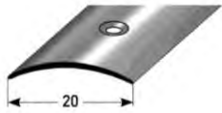

| 1,0 mm | 1,0mm, gebohrt, drilled | 0,9 | 41230-4 | 4,96 | |
|--------|---------------------------|-------------------------|---------|---------|-------|
| | | 1,0mm, ebohrt, drilled | 1,0 | 41240-3 | 5,50 |
| | | 1,0mm, gebohrt, drilled | 2,7 | 41250-2 | 14,86 |
| 1,5 mm | 1,5mm gebohrt, drilled | 1,0 | 42220-4 | 6,10 | |
| | 1,5mm , gebohrt, drilled | 2,7 | 42230-3 | 16,34 | |
| 2,0 mm | 2,0 mm , gebohrt, drilled | 1,0 | 42250-1 | 7,04 | |
| | 2,0 mm , gebohrt, drilled | 2,7 | 42260-0 | 19,04 | |

| | |
|---------|-------|
| 41231-1 | 5,74 |
| 41241-0 | 6,38 |
| 41251-9 | 17,20 |
| 42221-1 | 6,94 |
| 42231-0 | 18,76 |
| 42251-8 | 7,98 |
| 42261-7 | 21,46 |

Uebergangsp. 20 mm, Edelstahl matt

connecting profile 20 mm, stainless steel satin, with protective film

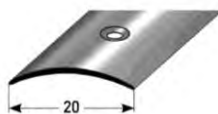

| 1,0 mm | 1,0mm, gebohrt, drilled | 1,0 | 42280-8 | 6,58 |
|--------|---------------------------|------------------------|---------|---------|
| | | 1,0mm, ebohrt, drilled | 2,7 | 42290-7 |
| 1,5 mm | 1,5mm gebohrt, drilled | 1,0 | 42310-2 | 8,38 |
| | 1,5mm gebohrt, drilled | 2,7 | 42320-1 | 22,62 |
| 2,0 mm | 2,0 mm , gebohrt, drilled | 1,0 | 42340-9 | 10,24 |
| | 2,0 mm , gebohrt, drilled | 2,7 | 42350-8 | 27,58 |

| | |
|---------|-------|
| 42281-5 | 7,48 |
| 42291-4 | 20,20 |
| 42311-9 | 9,32 |
| 42321-8 | 25,12 |
| 42341-6 | 11,14 |
| 42351-5 | 30,02 |

Uebergangprofil 28 mm, Messing pol.

connecting profile 28 mm, brass polished, with **140** active film

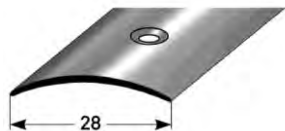

| 1,0 mm | 1,0mm, gebohrt, drilled | 0,9 | 3090-4 | 8,92 |
|--------|----------------------------|-----|--------|-------|
| | 1,0mm, gebohrt, drilled | 1,0 | 3100-0 | 9,90 |
| | 1,0mm, gebohrt, drilled | 2,0 | 3110-9 | 19,80 |
| | 1,0mm, gebohrt, drilled | 2,7 | 3120-8 | 26,70 |
| | 1,0mm, gebohrt, drilled | 0,9 | 3390-5 | 8,92 |
| | 1,0mm, gebohrt, drilled | 1,0 | 3400-1 | 9,90 |
| | 1,0mm, gebohrt, drilled | 2,0 | 3410-0 | 19,80 |
| | 1,0mm, gebohrt, drilled | 2,7 | 3420-9 | 26,70 |
| | 1,0mm, selbstkl.,self-adh. | 0,9 | 3093-5 | 10,14 |
| | 1,0mm, selbstkl.,self-adh. | 1,0 | 3103-1 | 11,12 |
| | 1,0mm, selbstkl.,self-adh. | 2,7 | 3123-9 | 30,00 |

| | |
|--------|-------|
| 3091-1 | 9,72 |
| 3101-7 | 10,70 |
| 3111-6 | 21,40 |
| 3121-5 | 29,14 |
| 3391-2 | 9,72 |
| 3401-8 | 10,70 |
| 3411-7 | 21,40 |
| 3421-6 | 29,14 |
| 3092-8 | 10,72 |
| 3102-4 | 11,72 |
| 3126-0 | 31,80 |

Bitte fordern Sie unsere Pflegehinweise fuer Messingprofile an!

Please ask for our care tips for brass profiles!

| 1,2 mm | gebohrt, drilled | 0,9 | 3095-9 | 10,26 |
|----------------------------|-----------------------------------|--------|--------|-------|
| | gebohrt, drilled | 1,0 | 3105-5 | 11,38 |
| | gebohrt, drilled | 2,7 | 3125-3 | 30,72 |
| | seitlich gebohrt,aterally drilled | 0,9 | 3094-2 | 10,26 |
| | seitlich gebohrt,aterally drilled | 1,0 | 2104-9 | 11,38 |
| | seitlich gebohrt,aterally drilled | 2,7 | 3124-6 | 30,72 |
| | 1,2mm, selbstkl.,self-adh. | 0,9 | 3097-3 | 11,44 |
| | 1,2mm, selbstkl.,self-adh. | 1,0 | 3107-9 | 12,58 |
| 1,2mm, selbstkl.,self-adh. | 2,7 | 3127-7 | 33,98 | |

| | |
|--------|-------|
| 3096-6 | 11,06 |
| 3106-2 | 12,16 |
| 3122-2 | 33,14 |
| 3099-7 | 11,06 |
| 3109-3 | 12,16 |
| 3129-1 | 33,14 |
| 3098-0 | 12,06 |
| 3108-6 | 13,18 |
| 3128-4 | 35,82 |

Laengen bis 5,0 m
Anfrage/ lengths up
5,0 m on request

4. UebergangSPROFILE/ 4. CONNECTING PROFILES

13 Seitlich gebohrt, ungebohrt oder Flachstreifen auf Anfrage erhaeltlich!
Laterally drilled, undrilled or as flat profile available on demand!

Uebergangspr. 28 mm, Edelst. Pol.

connecting profile 28 mm, stainless steel polished, with protective film

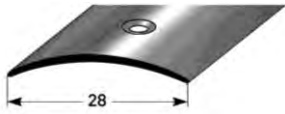

| Profi-Pack à 10 StUeck im Bund | | | | |
|--------------------------------|-------------|-----------|-----------|-------------|
| professional packing à 10 pcs. | | | | |
| Dicke + Befestigung fixing | thickness + | L / l (m) | Art./ref. | €/Stk./pcs. |

| SB-Pack incl. Schr./DUebel; VE 20 Stk. | |
|---|-------------|
| self-service-pack with screws/dowels; à 20 pcs. | |
| Art./ref. | €/Stk./pcs. |

| 1,0 mm | 1,0mm, gebohrt, drilled | | | | | |
|--------|---|---------|---------|---------|---------|-------|
| | | 0,9 | 4 | 4,00 | 3191-8 | 4,80 |
| | 1,0 | 3200-7 | 4,42 | 3201-4 | 5,22 | |
| | 2,0 | 3210-6 | 8,88 | 3211-3 | 10,44 | |
| | 2,7 | 3220-5 | 11,98 | 3221-2 | 14,40 | |
| 1,0 mm | 1,0mm, seitlich geb., laterally drilled | | | | | |
| | | 0,9 | 3490-2 | 4,00 | 3491-9 | 4,80 |
| | | 1,0 | 3500-8 | 4,42 | 3501-5 | 5,22 |
| | | 2,0 | 3510-7 | 8,88 | 3511-4 | 10,44 |
| | | 2,7 | 3520-6 | 11,98 | 3521-3 | 14,40 |
| | 1,0mm selbstkl., self-adhesive | | | | | |
| | | 0,9 | 3193-2 | 5,20 | 3192-5 | 5,82 |
| | | 1,0 | 3203-8 | 5,80 | 3202-1 | 6,38 |
| | 2,7 | 3223-6 | 15,60 | 3224-3 | 17,44 | |
| 1,5 mm | 1,5 mm gebohrt ,centr. drilled | | | | | |
| | | 1,0 | 42370-6 | 6,00 | 42371-3 | 6,82 |
| | | 2,7 | 42380-5 | 16,26 | 42381-2 | 18,70 |
| | 1,5mm selbstkl., self-adhesive | | | | | |
| | 1,0 | 42400-0 | 7,24 | 42401-7 | 7,84 | |
| | 2,7 | 42410-9 | 19,52 | 42411-6 | 21,36 | |
| 2,0 mm | 2,0mm mittig geb., entr. drilled | | | | | |
| | | 1,0 | 42430-7 | 7,22 | 42431-4 | 8,02 |
| | | 2,7 | 42440-6 | 19,46 | 42441-3 | 21,90 |
| | 2,0mm selbstkl., self-adhesive | | | | | |
| | 1,0 | 42460-4 | 8,42 | 42461-1 | 9,02 | |
| | 2,7 | 42470-3 | 22,76 | 42471-0 | 24,56 | |

Uebergangspr. 28 mm, Edelst. Matt

connecting profile 28 mm, stainless steel satin, with protective film

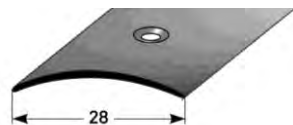

| 1,0 mm | 1,0mm, gebohrt, drilled | | | | | |
|--------|---|---------|---------|---------|---------|-------|
| | | 0,9 | 3690-6 | 5,22 | 3691-3 | 6,00 |
| | | 1,0 | 3700-2 | 5,82 | 3701-9 | 6,60 |
| | 2,7 | 3720-0 | 15,68 | 3721-7 | 18,08 | |
| 1,0 mm | 1,0mm, seitlich geb., laterally drilled | | | | | |
| | | 0,9 | 3790-3 | 5,22 | 3791-0 | 6,00 |
| | | 1,0 | 3800-9 | 5,82 | 3801-6 | 6,60 |
| | | 2,7 | 3820-7 | 15,68 | 3821-4 | 18,08 |
| | 1,0mm selbstkl., self-adhesive | | | | | |
| | | 0,9 | 3890-0 | 6,44 | 3891-7 | 7,04 |
| | 1,0 | 3900-6 | 7,02 | 3901-3 | 7,36 | |
| | 2,7 | 3920-4 | 18,94 | 3921-1 | 20,78 | |
| 1,5 mm | 1,5 mm gebohrt ,centr. drilled | | | | | |
| | | 1,0 | 60005-3 | 8,18 | 60006-0 | 8,98 |
| | | 2,7 | 60021-3 | 22,10 | 60023-7 | 24,52 |
| | 1,5mm selbstkl., self-adhesive | | | | | |
| | 1,0 | 60007-7 | 9,40 | 60024-4 | 9,98 | |
| | 2,7 | 60009-1 | 25,34 | 60026-8 | 27,22 | |
| 2,0 mm | 2,0mm mittig geb., entr. drilled | | | | | |
| | | 1,0 | 60530-0 | 10,84 | 60531-7 | 11,66 |
| | | 2,7 | 60542-3 | 29,34 | 60543-0 | 31,76 |
| | 2,0mm selbstkl., self-adhesive | | | | | |
| | 1,0 | 60532-4 | 12,32 | 60533-1 | 12,92 | |
| | 2,7 | 60538-6 | 33,26 | 60539-3 | 35,06 | |

4. UEBERGANGSPROFILE/ 4. CONNECTING PROFILES

Andere Eloxalfarben siehe **Abschnitt**
 6, Lieferzeit 14 Tage/ other anodized
 colours see section 6, delivery time 14 days

| Profi-Pack à 10 Stück im Bund | | | |
|--------------------------------|-----------|-----------|-------------|
| professional packing à 10 pcs. | | | |
| Farbe/colour | L / l (m) | Art./ref. | €/Stk./pcs. |

| SB-Pack incl. Schr./ DUebel; VE 20 Stk. | |
|--|-------------|
| self-service-pack with screws/ dowels; à 20 pcs. | |
| Art./ref. | €/Stk./pcs. |

Uebergangsp. 28 x 1,5 mm, Aluminium eloxiert, mittig gebohrt

connecting profile 28 x 1,5 mm,
 aluminium anodized,
 centrally drilled

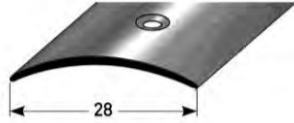

seitlich gebohrt auf Anfrage
 laterally drilled on request

| | | | |
|-----------------------------|-----|---------|-------|
| silver coloured | 0,9 | 8490-7 | 3,62 |
| silver coloured | 1.0 | 8500-3 | 4.02 |
| silver coloured | 2,0 | 8510-2 | 8,04 |
| silver coloured | 2,7 | 8520-1 | 10,86 |
| gold coloured | 0,9 | 8590-4 | 4,70 |
| gold coloured | 1,0 | 8600-0 | 5,22 |
| gold coloured | 2,0 | 8610-9 | 10,50 |
| gold coloured | 2,7 | 8620-8 | 14,20 |
| bronze light col. | 0,9 | 8690-1 | 4,98 |
| bronze light col. | 1,0 | 8700-7 | 5,54 |
| bronze light col. | 2,0 | 8710-6 | 11,10 |
| bronze light col. | 2,7 | 8720-5 | 14,96 |
| bronze dark col. | 0,9 | 8790-8 | 4,98 |
| bronze dark col. | 1,0 | 8800-4 | 5,54 |
| bronze dark col. | 2,0 | 8810-3 | 11,10 |
| bronze dark col. | 2,7 | 8820-2 | 14,96 |
| gold light col, | 0,9 | 70802-5 | 4,70 |
| gold light col, | 1,0 | 70804-9 | 5,22 |
| gold light col, | 2,0 | 70806-3 | 10,50 |
| gold light col. | 2,7 | 70808-7 | 14,20 |
| fine-hon.stainl. steel col. | 0,9 | 70818-6 | 4,98 |
| fine-hon.stainl. steel col. | 1,0 | 70820-9 | 5,54 |
| fine-hon.stainl. steel col. | 2,0 | 70822-3 | 11,10 |
| fine-hon.stainl. steel col. | 2,7 | 70824-7 | 14,96 |

| | |
|---------|-------|
| 8491-4 | 4,36 |
| 8501-0 | 4,76 |
| 8511-9 | 9,52 |
| 8521-8 | 12,96 |
| 8591-1 | 5,46 |
| 8601-7 | 6,10 |
| 8611-6 | 12,10 |
| 8621-5 | 16,34 |
| 8691-8 | 6,10 |
| 8701-4 | 6,76 |
| 8711-3 | 13,46 |
| 8721-2 | 18,22 |
| 8791-5 | 5,72 |
| 8801-1 | 6,34 |
| 8811-0 | 12,70 |
| 8821-9 | 17,10 |
| 70810-0 | 5,46 |
| 70812-4 | 6,10 |
| 70814-8 | 12,10 |
| 70816-2 | 16,34 |
| 70826-1 | 5,72 |
| 70828-5 | 6,34 |
| 70830-8 | 12,70 |
| 70832-2 | 17,10 |



Holzdekorfolie/ wood decor

| | | | |
|----------------------------|-----|---------|-------|
| Buche, beech | 1,0 | 38160-0 | 9,46 |
| Buche, beech | 2,7 | 38170-9 | 25,54 |
| Eiche, oak | 1,0 | 38180-8 | 9,46 |
| Eiche, oak | 2,7 | 38190-7 | 25,54 |
| Ahorn,maple | 1,0 | 38200-3 | 9,46 |
| Ahorn,maple | 2,7 | 38210-2 | 25,54 |
| Kirschbaum,cherry wood | 1,0 | 38220-1 | 9,46 |
| Kirschbaum,cherry wood | 2,7 | 38225-6 | 25,54 |
| Eiche rustikal ,rustic oak | 1,0 | 38230-0 | 9,46 |
| Eiche rustikal ,rustic oak | 2,7 | 38235-5 | 25,54 |

| | |
|---------|-------|
| 38161-7 | 10,30 |
| 38171-6 | 27,76 |
| 38181-5 | 10,30 |
| 38191-4 | 27,76 |
| 38201-0 | 10,30 |
| 38211-9 | 27,76 |
| 38221-8 | 10,30 |
| 38226-3 | 27,76 |
| 38231-7 | 10,30 |
| 38236-2 | 27,76 |

4. UeBERGANGSPROFILE/ 4. CONNECTING PROFILES

Andere Eloxalfarben siehe **Abschnitt 6, Lieferzeit 14 Tage/** other anodized colours see section 6, delivery time 14 days

| Profi-Pack à 10 StUeck im Bund | | | |
|--------------------------------|-----------|-----------|-------------|
| professional packing à 10 pcs. | | | |
| Farbe/colour | L / l (m) | Art./ref. | €/Stk./pcs. |

| SB-Pack; VE 20 Stk. | |
|------------------------------|-------------|
| self-service-pack; à 20 pcs. | |
| Art./ref. | €/Stk./pcs. |

Uebergangprofil.l 28 x 1,5 mm, Alu. eloxiert, selbstkl.

connecting profile 28 x 1,5 mm, aluminium anodized, self-adhesive

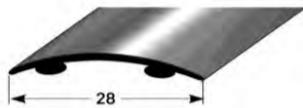

05

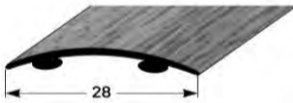

Holzdekorfolie/ wood decor

| | | | |
|-----------------------------|---------------------|-------------------------|-----------------------|
| silver coloured | 0,9 | 8493-8 | 5,18 |
| silver coloured | 1,0 | 8503-4 | 5,76 |
| silver coloured | 2,7 | 8523-2 | 15,56 |
| gold coloured | 0,9 | 8593-5 | 6,38 |
| gold coloured | 1,0 | 8603-1 | 7,12 |
| gold coloured | 2,7 | 8623-9 | 19,16 |
| bronze light col. | 0,9 | 8693-2 | 6,66 |
| bronze light col. | 1,0 | 8703-8 | 7,36 |
| bronze light col. | 2,7 | 8723-6 | 19,94 |
| bronze dark col. | 0,9 | 8793-9 | 6,66 |
| bronze dark col. | 1,0 | 8803-5 | 7,36 |
| bronze dark col. | 2,7 | 8823-3 | 19,94 |
| gold light col, | 0,9 | 70836-0 | 6,38 |
| gold light col, | 1,0 | 70838-4 | 7,12 |
| gold light col, | 2,7 | 70840-7 | 19,16 |
| fine-hon.stainl. steel col. | 0,9 | 70848-3 | 6,66 |
| fine-hon.stainl. steel col. | 1,0 | 70850-6 | 7,36 |
| fine-hon.stainl. steel col. | 2,7 | 70852-0 | 19,94 |
| | | | |
| Buche, beech | 1,0 | 38100-6 | 11,66 |
| Buche, beech | 2,7 | 38110-5 | 31,42 |
| Eiche, oak | 1,0 | 38120-4 | 11,66 |
| Eiche, oak | 2,7 | 38130-3 | 31,42 |
| Ahorn,maple | 1,0 | 38140-2 | 11,66 |
| Ahorn,maple | 2,7 | 38150-1 | 31,42 |
| Kirschbaum,cherry wood | 1,0 | 38240-9 | 11,66 |
| Kirschbaum,cherry wood | 2,7 | 38245-4 | 31,42 |
| Eiche rustikal ,rustic oak | 1,0 | 38250-8 | 11,66 |
| Eiche rustikal ,rustic oak | 2,7 | 38255-3 | 31,42 |

| | |
|-------------------------|-----------------------|
| 8492-1 | 5,68 |
| 8502-7 | 6,26 |
| 8524-9 | 17,02 |
| 8592-8 | 6,84 |
| 8602-4 | 7,62 |
| 8624-6 | 20,62 |
| 8692-5 | 7,14 |
| 8702-1 | 7,96 |
| 8724-3 | 21,38 |
| 8792-2 | 7,14 |
| 8802-8 | 7,96 |
| 8824-0 | 21,38 |
| 70842-1 | 6,84 |
| 70844-5 | 7,62 |
| 70846-9 | 20,62 |
| 70854-4 | 7,14 |
| 70856-8 | 7,96 |
| 70858-2 | 21,38 |

| | |
|-------------------------|-----------------------|
| 38101-3 | 12,12 |
| 38111-2 | 32,82 |
| 38121-1 | 12,12 |
| 38131-0 | 32,82 |
| 38141-9 | 12,12 |
| 38151-8 | 32,82 |
| 38241-6 | 12,12 |
| 38246-1 | 32,82 |
| 38251-5 | 12,12 |
| 38256-0 | 32,82 |

4. UEBERGANGSPROFILE/ 4. CONNECTING PROFILES

Andere Eloxalfarben siehe

Abchnitt 6, Lieferzeit 14 Tage/

10 Anodized colours see section 6,
delivery time 14 days

Uebergangsp. 24,5 x 1,25 mm,

24,5 x 1,25 mm,

Aluminium eloxiert,

mittig gebohrt

connecting profile 24,5 x 1,25 mm,
aluminium anodized,
centrally drilled

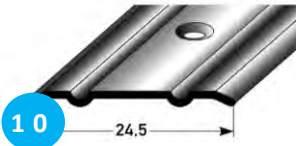

| Profi-Pack à 10 StUeck im Bund | | | |
|--------------------------------|-----------|-----------|-------------|
| professional packing à 10 pcs. | | | |
| Farbe/colour | L / l (m) | Art./ref. | €/Stk./pcs. |
| silver coloured | 0,9 | 31105-8 | 4,52 |
| silver coloured | 1.0 | 31110-2 | 5.00 |
| silver coloured | 2.7 | 31115-7 | 13.50 |
| gold coloured | 0.9 | 31120-1 | 4.60 |
| gold coloured | 1.0 | 31125-6 | 5.10 |
| gold coloured | 2.7 | 31130-0 | 13.82 |
| bronze light col. | 0.9 | 31135-5 | 5.12 |
| bronze light col. | 1.0 | 31140-9 | 5.72 |
| bronze light col. | 2.7 | 31145-4 | 15.40 |
| bronze dark col. | 0.9 | 31150-8 | 5.12 |
| bronze dark col. | 1.0 | 31155-3 | 5.72 |
| bronze dark col. | 2.7 | 31160-7 | 15.40 |

| SB-Pack incl. Schr./ DUebel; VE 20 Stk. | |
|---|-------------|
| self-service-pack with screws/ dowels; à 20 pcs. | |
| Art./ref. | €/Stk./pcs. |
| 31106-5 | 5,20 |
| 31111-9 | 5.82 |
| 31116-4 | 15.66 |
| 31121-8 | 5.32 |
| 31126-3 | 5.90 |
| 31131-7 | 15.98 |
| 31136-2 | 6.22 |
| 31141-6 | 6.90 |
| 31146-1 | 18.66 |
| 31151-5 | 5.86 |
| 31156-0 | 6.52 |
| 31161-4 | 17.58 |

Uebergangsp. 24,5 x 1,25 mm,

24,5 x 1,25 mm,

Aluminium eloxiert,

selbstklebend

connecting profile 24,5 x 1,25 mm,
aluminium anodized,
self-adhesive

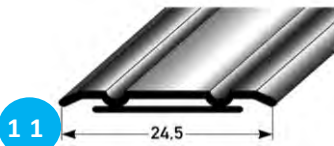

| | | | |
|-------------------|-----|---------|-------|
| silver coloured | 0.9 | 31107-2 | 6.16 |
| silver coloured | 1.0 | 31112-6 | 6.82 |
| silver coloured | 2.7 | 31118-8 | 18.42 |
| gold coloured | 0.9 | 31122-5 | 6.26 |
| gold coloured | 1.0 | 31127-0 | 6.94 |
| gold coloured | 2.7 | 31133-1 | 18.76 |
| bronze light col. | 0.9 | 31137-9 | 6.78 |
| bronze light col. | 1.0 | 31142-3 | 7.54 |
| bronze light col. | 2.7 | 31148-5 | 20.32 |
| bronze dark col. | 0.9 | 31152-2 | 6.78 |
| bronze dark col. | 1.0 | 31157-7 | 7.54 |
| bronze dark col. | 2.7 | 31163-8 | 20.32 |

| | |
|---------|-------|
| 31108-9 | 6.66 |
| 31113-3 | 7.36 |
| 31117-1 | 19.94 |
| 31123-2 | 6.76 |
| 31128-7 | 7.48 |
| 31132-4 | 20.20 |
| 31138-6 | 7.28 |
| 31143-0 | 8.08 |
| 31147-8 | 21.82 |
| 31153-9 | 7.28 |
| 31158-4 | 8.08 |
| 31162-1 | 21.82 |

Uebergangsp. 27 x 1,7 mm,

27 x 1,7 mm,

Aluminium eloxiert,

mittig gebohrt

connecting profile 27 x 1,7 mm,
aluminium anodized,
centrally drilled

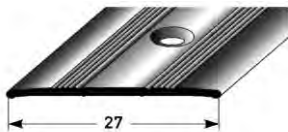

| | | | |
|-------------------|-----|---------|-------|
| silver coloured | 0.9 | 23090-8 | 3.52 |
| silver coloured | 1.0 | 23100-4 | 3.92 |
| silver coloured | 2.0 | 23120-2 | 7.84 |
| silver coloured | 2.7 | 23110-3 | 10.58 |
| gold coloured | 0.9 | 23190-5 | 4.80 |
| gold coloured | 1.0 | 23200-1 | 5.30 |
| gold coloured | 2.0 | 23220-9 | 10.64 |
| gold coloured | 2.7 | 23210-0 | 14.38 |
| bronze light col. | 0.9 | 23290-2 | 5.28 |
| bronze light col. | 1.0 | 23300-8 | 5.88 |
| bronze light col. | 2.0 | 23320-6 | 11.80 |
| bronze light col. | 2.7 | 23310-7 | 15.88 |
| bronze dark col. | 0.9 | 23390-9 | 5.28 |
| bronze dark col. | 1.0 | 23400-5 | 5.88 |
| bronze dark col. | 2.0 | 23420-3 | 11.80 |
| bronze dark col. | 2.7 | 23410-4 | 15.88 |

| | |
|---------|-------|
| 23091-5 | 4.28 |
| 23101-1 | 4.68 |
| 23111-0 | 12.64 |
| 23191-2 | 5.52 |
| 23201-8 | 6.14 |
| 23211-7 | 16.54 |
| 23291-9 | 6.38 |
| 23301-5 | 7.12 |
| 23311-4 | 19.14 |
| 23391-6 | 6.00 |
| 23401-2 | 6.70 |
| 23411-1 | 18.04 |

Uebergangsp. 27 x 1,7 mm,

27 x 1,7 mm,

Aluminium eloxiert,

selbstklebend

connecting profile 27 x 1,7 mm,
aluminium anodized,
self-adhesive

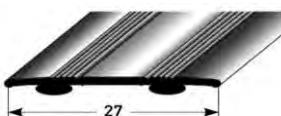

| | | | |
|-------------------|-----|---------|-------|
| silver coloured | 0.9 | 23093-9 | 5.02 |
| silver coloured | 1.0 | 23103-5 | 5.54 |
| silver coloured | 2.7 | 23123-3 | 14.94 |
| gold coloured | 0.9 | 23193-6 | 6.28 |
| gold coloured | 1.0 | 23203-2 | 6.98 |
| gold coloured | 2.7 | 23223-0 | 18.86 |
| bronze light col. | 0.9 | 23293-3 | 6.80 |
| bronze light col. | 1.0 | 23303-9 | 7.56 |
| bronze light col. | 2.7 | 23323-7 | 20.38 |
| bronze dark col. | 0.9 | 23393-0 | 6.80 |
| bronze dark col. | 1.0 | 23403-6 | 7.56 |
| bronze dark col. | 2.7 | 23423-4 | 20.38 |

| | |
|---------|-------|
| 23092-2 | 5.52 |
| 23102-8 | 6.04 |
| 23122-6 | 16.44 |
| 23192-9 | 6.78 |
| 23202-5 | 7.54 |
| 23222-3 | 20.32 |
| 23292-6 | 7.30 |
| 23302-2 | 8.10 |
| 23322-0 | 21.86 |
| 23392-3 | 7.30 |
| 23402-9 | 8.10 |
| 23422-7 | 21.86 |

Andere Eloxalfarben siehe
Abschnitt 6, Lieferzeit 14 Tage/

06 anodized colours see section 6,
delivery time 14 days

4. Uebergangsp Profile / 4. CONNECTING PROFILES

| Profi-Pack à 10 Stueck im Bund | | | |
|--------------------------------|-----------|-----------|-------------|
| professional packing à 10 pcs. | | | |
| Farbe/colour | L / l (m) | Art./ref. | €/Stk./pcs. |

| SB-Pack incl. Schr./ DUebel; VE 20 Stk. | |
|---|-------------|
| self-service-pack with screws/ dowels; à 20 pcs. | |
| Art./ref. | €/Stk./pcs. |

Steg-Uebergangprofil 28 x 4,5 mm, Aluminium eloxiert, mittig gebohrt

connecting profile with bars
28 x 4,5 mm, aluminium
anodized,
centrally drilled

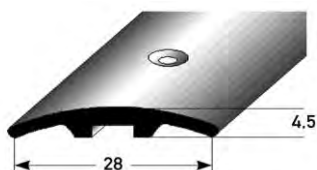

| | | | |
|-------------------|---------------------|-------------------------|-----------------------|
| silver coloured | 0,9 | 31205-5 | 6,18 |
| silver coloured | 1,0 | 31210-9 | 6,84 |
| silver coloured | 2,7 | 31215-4 | 18,48 |
| gold coloured | 0,9 | 31220-8 | 6,26 |
| gold coloured | 1,0 | 31225-3 | 6,92 |
| gold coloured | 2,7 | 31230-7 | 18,74 |
| bronze light col. | 0,9 | 31235-2 | 6,46 |
| bronze light col. | 1,0 | 31240-6 | 7,18 |
| bronze light col. | 2,7 | 31245-1 | 19,36 |
| bronze dark col. | 0,9 | 31250-5 | 6,46 |
| bronze dark col. | 1,0 | 31255-0 | 7,18 |
| bronze dark col. | 2,7 | 31260-4 | 19,36 |

| | |
|-------------------------|-----------------------|
| 31207-9 | 6,90 |
| 31212-3 | 7,64 |
| 31217-8 | 20,72 |
| 31222-2 | 6,98 |
| 31227-7 | 7,72 |
| 31232-1 | 20,92 |
| 31237-6 | 7,54 |
| 31242-0 | 8,36 |
| 31247-5 | 22,58 |
| 31252-9 | 7,20 |
| 31257-4 | 8,00 |
| 31262-8 | 21,54 |

06

Steg-Uebergangprofil 28 x 4,5 mm, Aluminium eloxiert, selbstklebend

connecting profile with bars
28 x 4,5 mm, aluminium
anodized,
self-adhesive

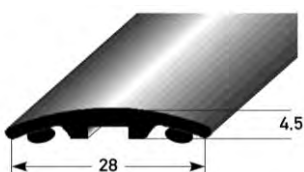

| | | | |
|-------------------|---------------------|-------------------------|-----------------------|
| silver coloured | 0,9 | 31206-2 | 7,82 |
| silver coloured | 1,0 | 31211-6 | 8,70 |
| silver coloured | 2,7 | 31216-1 | 23,48 |
| gold coloured | 0,9 | 31221-5 | 7,96 |
| gold coloured | 1,0 | 31226-0 | 8,80 |
| gold coloured | 2,7 | 31231-4 | 23,74 |
| bronze light col. | 0,9 | 31236-9 | 8,10 |
| bronze light col. | 1,0 | 31241-3 | 9,00 |
| bronze light col. | 2,7 | 31246-8 | 24,32 |
| bronze dark col. | 0,9 | 31251-2 | 8,10 |
| bronze dark col. | 1,0 | 31256-7 | 9,00 |
| bronze dark col. | 2,7 | 31261-1 | 24,32 |

| | |
|-------------------------|-----------------------|
| 31208-6 | 8,28 |
| 31213-0 | 9,26 |
| 31218-5 | 24,98 |
| 31223-9 | 8,38 |
| 31228-4 | 9,36 |
| 31233-8 | 25,18 |
| 31238-3 | 8,62 |
| 31243-7 | 9,54 |
| 31248-2 | 25,78 |
| 31253-6 | 8,62 |
| 31258-1 | 9,54 |
| 31263-5 | 25,78 |

4. UEBERGANGSPROFILE/ 4. CONNECTING PROFILES

Andere Eloxalfarben siehe
Abschnitt 6, Lieferzeit 14 Tage/

07 anodized colours see section 6,
delivery time 14 days

| Profi-Pack à 10 StUeck im Bund | | | |
|--------------------------------|-----------|-----------|-------------|
| professional packing à 10 pcs. | | | |
| Farbe/colour | L / l (m) | Art./ref. | €/Stk./pcs. |

| SB-Pack incl. Schr./ DUebel; VE 20 Stk. | |
|---|-------------|
| self-service-pack with screws/ dowels; à 20 pcs. | |
| Art./ref. | €/Stk./pcs. |

Uebergangprofil 37 x 4,5 mm, Aluminium eloxiert, mittig gebohrt

connecting profile 37 x 4,5 mm,
aluminium anodized,
centrally drilled

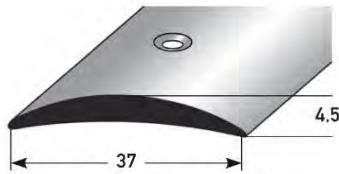

07

| | | | |
|-------------------|---------------------|-------------------------|-----------------------|
| silver coloured | 0,9 | 31305-2 | 7,96 |
| silver coloured | 1,0 | 31310-6 | 8,82 |
| silver coloured | 2,7 | 31315-1 | 23,80 |
| gold coloured | 0,9 | 31320-5 | 8,14 |
| gold coloured | 1,0 | 31325-0 | 9,02 |
| gold coloured | 2,7 | 31330-4 | 24,40 |
| bronze light col. | 0,9 | 31335-9 | 8,86 |
| bronze light col. | 1,0 | 31340-3 | 9,82 |
| bronze light col. | 2,7 | 31345-8 | 26,54 |
| bronze dark col. | 0,9 | 31350-2 | 8,86 |
| bronze dark col. | 1,0 | 31355-7 | 9,82 |
| bronze dark col. | 2,7 | 31360-1 | 26,54 |

| | |
|-------------------------|-----------------------|
| 31307-6 | 8,66 |
| 31312-0 | 9,60 |
| 31317-5 | 25,96 |
| 31322-9 | 8,88 |
| 31327-4 | 9,84 |
| 31332-8 | 26,58 |
| 31337-3 | 9,92 |
| 31342-7 | 11,06 |
| 31347-2 | 29,74 |
| 31352-6 | 9,56 |
| 31357-1 | 10,64 |
| 31362-5 | 28,72 |

Uebergangprofil 37 x 4,5 mm, Aluminium eloxiert, seitlich gebohrt

connecting profile 37 x 4,5 mm,
aluminium anodized,
laterally drilled

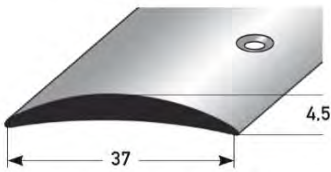

07

| | | | |
|-------------------|---------------------|-------------------------|-----------------------|
| silver coloured | 0,9 | 47700-6 | 7,96 |
| silver coloured | 1,0 | 47702-0 | 8,82 |
| silver coloured | 2,7 | 47704-4 | 23,80 |
| gold coloured | 0,9 | 47712-9 | 8,14 |
| gold coloured | 1,0 | 47714-3 | 9,02 |
| gold coloured | 2,7 | 47716-7 | 24,40 |
| bronze light col. | 0,9 | 47724-2 | 8,86 |
| bronze light col. | 1,0 | 47726-6 | 9,82 |
| bronze light col. | 2,7 | 47728-0 | 26,54 |
| bronze dark col. | 0,9 | 47736-5 | 8,86 |
| bronze dark col. | 1,0 | 47738-9 | 9,82 |
| bronze dark col. | 2,7 | 47740-2 | 26,54 |

| | |
|-------------------------|-----------------------|
| 47706-8 | 8,66 |
| 47708-2 | 9,60 |
| 47710-5 | 25,96 |
| 47718-1 | 8,88 |
| 47720-4 | 9,84 |
| 47722-8 | 26,58 |
| 47730-3 | 9,92 |
| 47732-7 | 11,06 |
| 47734-1 | 29,74 |
| 47742-6 | 9,56 |
| 47744-0 | 10,64 |
| 47746-4 | 28,72 |

Uebergangprofil 37 x 4,5 mm, Aluminium eloxiert, selbstklebend

connecting profile 37 x 4,5 mm,
aluminium anodized,
self-adhesive

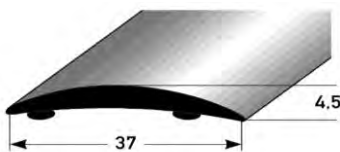

| | | | |
|-------------------|---------------------|-------------------------|-----------------------|
| silver coloured | 0,9 | 31306-9 | 9,58 |
| silver coloured | 1,0 | 31311-3 | 10,66 |
| silver coloured | 2,7 | 31316-8 | 28,76 |
| gold coloured | 0,9 | 31321-2 | 9,80 |
| gold coloured | 1,0 | 31326-7 | 10,84 |
| gold coloured | 2,7 | 31331-1 | 29,36 |
| bronze light col. | 0,9 | 31336-6 | 10,50 |
| bronze light col. | 1,0 | 31341-0 | 11,66 |
| bronze light col. | 2,7 | 31346-5 | 31,48 |
| bronze dark col. | 0,9 | 31351-9 | 10,50 |
| bronze dark col. | 1,0 | 31356-4 | 11,66 |
| bronze dark col. | 2,7 | 31361-8 | 31,48 |

| | |
|-------------------------|-----------------------|
| 31308-3 | 10,04 |
| 31313-7 | 11,18 |
| 31318-2 | 30,20 |
| 31323-6 | 10,28 |
| 31328-1 | 11,40 |
| 31333-5 | 30,80 |
| 31338-0 | 10,98 |
| 31343-4 | 12,16 |
| 31348-9 | 32,90 |
| 31353-3 | 10,98 |
| 31358-8 | 12,16 |
| 31363-2 | 32,90 |

Beispiel: Uebergangprofil 37 x 4,5 mm,
Aluminium (siehe oben) /
example: connecting profile 37 x 4,5 mm,
aluminium (see above)





4. UeBERGANGSPROFILE/ 4. CONNECTING PROFILES

Seitlich gebohrt, ungebohrt oder als Flachstreifen auf Anfrage erhaeltlich!
Laterally drilled, undrilled or as flat profil available on demand!

02 Profil 37 mm Messing
37 mm,
Messing poliert,
mit Schutzfolie

connecting profile 37 mm,
brass polished,
with protective film

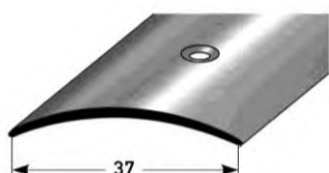

| Profi-Pack à 10 StUeck im Bund | | | | | SB-Pack incl. Schr./DUebel; VE 20 Stk. | |
|--------------------------------|---|-----------|-----------|-------------|---|-------------|
| professional packing à 10 pcs. | | | | | self-service-pack with screws/dowels; à 20 pcs. | |
| Dicke + Befestigung | thickness + fixing | L / l (m) | Art./ref. | €/Stk./pcs. | Art./ref. | €/Stk./pcs. |
| 1,0 mm | 1,0mm, gebohrt, drilled | 0,9 | 06090-1 | 12,14 | 06091-8 | 12,94 |
| | 1,0mm, gebohrt, drilled | 1,0 | 06100-7 | 13,52 | 06101-4 | 14,30 |
| | 1,0mm, gebohrt, drilled | 2,0 | 06110-6 | 27,00 | | |
| | 1,0mm, gebohrt, drilled | 2,7 | 06120-5 | 36,46 | 06121-2 | 38,90 |
| | 1,0mm, seitlich geb. ,laterally drilled | 0,9 | 06390-2 | 12,14 | 06391-9 | 12,94 |
| | 1,0mm, seitlich geb. ,laterally drilled | 1,0 | 06400-8 | 13,52 | 06401-5 | 14,30 |
| | 1,0mm, seitlich geb. ,laterally drilled | 2,0 | 06410-7 | 27,00 | | |
| | 1,0mm, seitlich geb. ,laterally drilled | 2,7 | 06420-6 | 36,46 | 06421-3 | 38,90 |
| | 1,0mmselfbstkl., self-adhesive | 0,9 | 06093-2 | 13,38 | 06092-5 | 13,96 |
| | 1,0mmselfbstkl., self-adhesive | 1,0 | 06103-8 | 14,72 | 06102-1 | 15,32 |
| 1,0mmselfbstkl., self-adhesive | 2,7 | 06123-6 | 42,16 | 06122-9 | 43,98 | |
| 1,2 mm | 1,2mm, mittig gebohrt, centrally drilled | 0,9 | 06095-6 | 13,42 | 06096-3 | 14,22 |
| | 1,2mm, mittig gebohrt, centrally drilled | 1,0 | 06105-2 | 14,90 | 06106-9 | 15,70 |
| | 1,2mm, mittig gebohrt, centrally drilled | 2,7 | 06125-0 | 40,26 | 06126-7 | 42,68 |
| | 1,2mm, seitlich gebohrt,laterally drilled | 0,9 | 06094-9 | 13,42 | 06099-4 | 14,22 |
| | 1,2mm, seitlich gebohrt,laterally drilled | 1,0 | 06104-5 | 14,90 | 06109-0 | 15,70 |
| | 1,2mm, seitlich gebohrt,laterally drilled | 2,7 | 06124-3 | 40,26 | 06129-8 | 42,68 |
| | 1,2 mm, selbstklebend ,self-adhesive | 0,9 | 06097-0 | 14,62 | 06098-7 | 15,24 |
| | 1,2 mm, selbstklebend ,self-adhesive | 1,0 | 06107-6 | 16,14 | 06108-3 | 16,72 |
| | 1,2 mm, selbstklebend ,self-adhesive | 2,7 | 06127-4 | 43,54 | 06128-1 | 45,34 |

15 Profil 37 mm Edelstahl,staier
37 mm,
Edelstahl poliert,
mit Schutzfolie

connecting profile 37 mm,
stainless steel polished,
with protective film

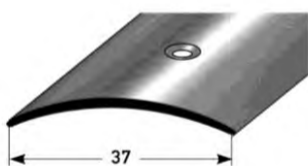

| | | | | | | |
|--------------------------------|--|---------|---------|---------|---------|-------|
| 1,0 mm | 1,0mm, gebohrt, drilled | 0,9 | 06190-8 | 4,90 | 06191-5 | 5,72 |
| | 1,0mm, gebohrt, drilled | 1,0 | 06200-4 | 5,46 | 06201-1 | 6,26 |
| | 1,0mm, gebohrt, drilled | 2,0 | 06210-3 | 10,88 | | |
| | 1,0mm, gebohrt, drilled | 2,7 | 06220-2 | 14,72 | 06221-9 | 17,14 |
| | 1,0mm, seitlich geb. ,laterally drilled | 0,9 | 06490-9 | 4,90 | 06491-6 | 5,72 |
| | 1,0mm, seitlich geb. ,laterally drilled | 1,0 | 06500-5 | 5,46 | 06501-2 | 6,26 |
| | 1,0mm, seitlich geb. ,laterally drilled | 2,0 | 06510-4 | 10,88 | | |
| | 1,0mm, seitlich geb. ,laterally drilled | 2,7 | 06520-3 | 14,72 | 06521-0 | 17,14 |
| | 1,0mmselfbstkl., self-adhesive | 0,9 | 06193-9 | 6,14 | 06192-2 | 6,72 |
| | 1,0mmselfbstkl., self-adhesive | 1,0 | 06203-5 | 6,66 | 06202-8 | 7,88 |
| 1,0mmselfbstkl., self-adhesive | 2,7 | 06223-3 | 17,96 | 06222-6 | 20,38 | |
| 1,5 mm | 1,5 mm, mittig gebohrt,centrally drilled | 1,0 | 42490-1 | 6,68 | 42491-8 | 7,48 |
| | 1,5 mm, mittig gebohrt,centrally drilled | 2,7 | 42500-7 | 18,02 | 42501-4 | 20,46 |
| | 1,5mm, selbstklebend, self-adhesive | 1,0 | 42520-5 | 7,90 | 42521-2 | 8,52 |
| | 1,5mm, selbstklebend, self-adhesive | 2,7 | 42530-4 | 21,30 | 42531-1 | 23,72 |
| 2,0 mm | 2,0mm, mittig gebohrt ,entrally drilled | 1,0 | 42550-2 | 8,14 | 42551-9 | 8,94 |
| | 2,0mm, mittig gebohrt ,entrally drilled | 2,7 | 42560-1 | 21,94 | 42561-8 | 24,36 |
| | 2,0mmselfbstkl., self-adhesive | 1,0 | 42580-9 | 9,36 | 42581-6 | 10,02 |
| | 2,0mmselfbstkl., self-adhesive | 2,7 | 42590-8 | 25,22 | 42591-5 | 27,02 |

16 Profil 37 mm Edelstahl Matt ,stainl. s
37 mm,
Edelstahl matt,
mit Schutzfolie

connecting profile 37 mm,
stainless steel satin,
with protective film

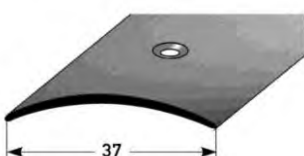

| | | | | | | |
|--|---|--|---------|---------|---------|---------|
| 1,0 mm | 1,0mm, mittig gebohrt, centrally drilled | 0,9 | 06690-3 | 6,76 | 06691-0 | 7,56 |
| | 1,0mm, mittig gebohrt, centrally drilled | 1,0 | 06700-9 | 7,52 | 06701-6 | 8,28 |
| | 1,0mm, mittig gebohrt, centr.drilled | 2,7 | 06720-7 | 20,26 | 06721-4 | 22,70 |
| | 1,0mm, seitlich gebohrt,laterally drilled | 0,9 | 06790-0 | 6,76 | 06791-7 | 7,56 |
| | 1,0mm, seitlich gebohrt,laterally drilled | 1,0 | 06800-6 | 7,52 | 06801-3 | 8,28 |
| | 1,0mm, seitlich gebohrt,laterally drilled | 2,7 | 06820-4 | 20,26 | 06821-1 | 22,70 |
| | 1,0mmselfbstkl., self-adhesive | 0,9 | 06890-7 | 7,98 | 06891-4 | 8,58 |
| | 1,0mmselfbstkl., self-adhesive | 1,0 | 06900-3 | 8,70 | 06901-0 | 9,34 |
| | 1,0mmselfbstkl., self-adhesive | 2,7 | 06920-1 | 23,52 | 06921-8 | 25,96 |
| | 1,5 mm | 1,5 mm, mittig gebohrt,centrally drilled | 1,0 | 60025-1 | 10,04 | 42601-1 |
| 1,5 mm, mittig gebohrt,centra. drilled | | 2,7 | 42600-4 | 27,22 | 42603-5 | 29,62 |
| 1,5mm, selbstklebend, self-adhesive | | 1,0 | 42610-3 | 11,28 | 42611-0 | 11,88 |
| 1,5mm, selbstklebend, self-adhesive | | 2,7 | 42630-1 | 30,46 | 42631-8 | 32,88 |
| 2,0 mm | 2,0mm, mittig gebohrt ,entrally drilled | 1,0 | 60545-4 | 12,68 | 42641-7 | 13,46 |
| | 2,0mm, mittig gebohrt ,entrally drilled | 2,7 | 42640-0 | 34,18 | 42643-1 | 36,58 |
| | 2,0mmselfbstkl., self-adhesive | 1,0 | 42650-9 | 13,86 | 42651-6 | 14,48 |
| | 2,0mmselfbstkl., self-adhesive | 2,7 | 42670-7 | 37,42 | 42671-4 | 39,86 |



BODENBELAG

4. UebergangSPROFILE/ 4. CONNECTING PROFILES

Andere Eloxalfarben siehe Abschnitt 6, Lieferzeit 14 Tage/
other anodized colours see section 6,
delivery time 14 days

| Profi-Pack à 10 StUeck im Bund | | | |
|--------------------------------|-----------|-----------|-------------|
| professional packing à 10 pcs. | | | |
| Farbe/colour | L / l (m) | Art./ref. | €/Stk./pcs. |

| SB-Pack incl. Schr./DUebel; VE 20 Stk. | |
|---|-------------|
| self-service-pack with screws/dowels; à 20 pcs. | |
| Art./ref. | €/Stk./pcs. |

Uebergangsprofil 38 x 1,8 mm, Aluminium eloxiert, gebohrt

connecting profile 38 x 1,8 mm,
aluminium anodized,
drilled

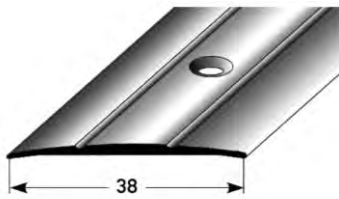

1 2

| | | | |
|------------------------------|-----|---------|-------|
| silberfarbig silver coloured | 0.9 | 23490-6 | 3.88 |
| silberfarbig silver coloured | 1.0 | 23500-2 | 4.32 |
| silberfarbig silver coloured | 2.0 | 23510-1 | 8.64 |
| silberfarbig silver coloured | 2.7 | 23520-0 | 11.66 |
| goldfarbiggold coloured | 0.9 | 23590-3 | 5.50 |
| goldfarbiggold coloured | 1.0 | 23600-9 | 6.12 |
| goldfarbiggold coloured | 2.0 | 23610-8 | 12.18 |
| goldfarbiggold coloured | 2.7 | 23620-7 | 16.50 |
| bronze light col. | 0.9 | 23690-0 | 5.86 |
| bronze light col. | 1.0 | 23700-6 | 6.52 |
| bronze light col. | 2.0 | 23710-5 | 13.00 |
| bronze light col. | 2.7 | 23720-4 | 17.58 |
| bronze dark col. | 0.9 | 23790-7 | 5.86 |
| bronze dark col. | 1.0 | 23800-3 | 6.52 |
| bronze dark col. | 2.0 | 23810-2 | 13.00 |
| bronze dark col. | 2.7 | 23820-1 | 17.58 |
| Buche, beech | 1.0 | 38340-6 | 10.42 |
| Buche, beech | 2.7 | 38350-5 | 28.18 |
| Eiche, oak | 1.0 | 38360-4 | 10.42 |
| Eiche, oak | 2.7 | 38370-3 | 28.18 |
| Ahorn, maple | 1.0 | 38380-2 | 10.42 |
| Ahorn, maple | 2.7 | 38390-1 | 28.18 |
| Kirschbaum, cherry wood | 1.0 | 38400-7 | 10.42 |
| Kirschbaum, cherry wood | 2.7 | 38405-2 | 28.18 |
| Eiche rustikal ,rustic oak | 1.0 | 38410-6 | 10.42 |
| Eiche rustikal ,rustic oak | 2.7 | 38415-1 | 28.18 |

Holzdekorfolie/ wood decor

1 2

| | |
|---------|-------|
| 23491-3 | 4.58 |
| 23501-9 | 5.08 |
| 23521-7 | 13.76 |
| 23591-0 | 6.24 |
| 23601-6 | 6.92 |
| 23621-4 | 18.70 |
| 23691-7 | 6.92 |
| 23701-3 | 7.70 |
| 23721-1 | 20.80 |
| 23791-4 | 6.58 |
| 23801-0 | 7.32 |
| 23821-8 | 19.74 |
| 38341-3 | 11.26 |
| 38351-2 | 30.42 |
| 38361-1 | 11.26 |
| 38371-0 | 30.42 |
| 38381-9 | 11.26 |
| 38391-8 | 30.42 |
| 38401-4 | 11.26 |
| 38406-9 | 30.42 |
| 38411-3 | 11.26 |
| 38416-8 | 30.42 |

Uebergangspr.38 x 1,8 mm, Alu. eloxiert, selbstklebend

connecting profile 38 x 1,8 mm,
aluminium anodized,
self-adhesive

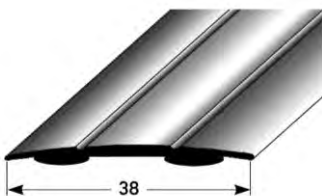

| | | | |
|----------------------------|-----|---------|-------|
| silver coloured | 0.9 | 23493-7 | 5.48 |
| silver coloured | 1.0 | 23503-3 | 6.06 |
| silver coloured | 2.7 | 23523-1 | 16.46 |
| gold coloured | 0.9 | 23593-4 | 7.16 |
| gold coloured | 1.0 | 23603-0 | 7.98 |
| gold coloured | 2.7 | 23623-8 | 21.46 |
| bronze light col. | 0.9 | 23693-1 | 7.52 |
| bronze light col. | 1.0 | 23703-7 | 8.32 |
| bronze light col. | 2.7 | 23723-5 | 22.54 |
| bronze dark col. | 0.9 | 23793-8 | 7.52 |
| bronze dark col. | 1.0 | 23803-4 | 8.32 |
| bronze dark col. | 2.7 | 23823-2 | 22.54 |
| Buche, beech | 1.0 | 38280-5 | 12.60 |
| Buche, beech | 2.7 | 38290-4 | 34.02 |
| Eiche, oak | 1.0 | 38300-0 | 12.60 |
| Eiche, oak | 2.7 | 38310-9 | 34.02 |
| Ahorn, maple | 1.0 | 38320-8 | 12.60 |
| Ahorn, maple | 2.7 | 38330-7 | 34.02 |
| Kirschbaum, cherry wood | 1.0 | 38420-5 | 12.60 |
| Kirschbaum, cherry wood | 2.7 | 38425-0 | 34.02 |
| Eiche rustikal ,rustic oak | 1.0 | 38430-4 | 12.60 |
| Eiche rustikal ,rustic oak | 2.7 | 38435-9 | 34.02 |

Holzdekorfolie/ wood decor

| | |
|---------|-------|
| 23492-0 | 5.98 |
| 23502-6 | 6.60 |
| 23522-4 | 17.96 |
| 23592-7 | 7.62 |
| 23602-3 | 8.50 |
| 23622-1 | 22.92 |
| 23692-4 | 8.02 |
| 23702-0 | 8.90 |
| 23722-8 | 23.96 |
| 23792-1 | 8.02 |
| 23802-7 | 8.90 |
| 23822-5 | 23.96 |
| 38281-2 | 13.14 |
| 38291-1 | 35.44 |
| 38301-7 | 13.14 |
| 38311-6 | 35.44 |
| 38321-5 | 13.14 |
| 38331-4 | 35.44 |
| 38421-2 | 13.14 |
| 38426-7 | 35.44 |
| 38431-1 | 13.14 |
| 38436-6 | 35.44 |

4. UEBERGANGSPROFILE/ 4. CONNECTING PROFILES

Andere Eloxalfarben siehe Abschnitt 6, Lieferzeit 14 Tage/
other anodized colours see section 6, delivery time 14 days

| Profi-Pack à 10 StUeck im Bund | | | |
|-----------------------------------|-----------|-----------|-------------|
| 03 Professional packing à 10 pcs. | | | |
| Farbe/colour | L / l (m) | Art./ref. | €/Stk./pcs. |

| SB-Pack incl. Schr./DUebel; VE 20 Stk. | |
|---|-------------|
| self-service-pack with screws/dowels; à 20 pcs. | |
| Art./ref. | €/Stk./pcs. |

Uebergangsp. 48 x 2 mm, Messing poliert

connecting profile 48 x 2 mm, brass polished, with protective foil

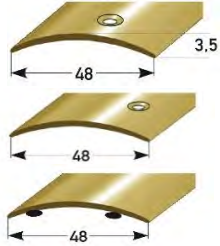

| | | | |
|------------------------------|-----|---------|-------|
| mittig geb., centr. drill. | 1,0 | 28761-2 | 34,74 |
| mittig geb., centr. drill. | 2,5 | 28760-5 | 86,86 |
| seitlich geb.,later. drill. | 1,0 | 48060-0 | 34,74 |
| seitlich geb.,later. drill. | 2,5 | 48062-4 | 86,86 |
| selbstklebend ,self-adhesive | 1,0 | 48070-9 | 36,48 |
| selbstklebend ,self-adhesive | 2,5 | 48072-3 | 91,18 |

| | |
|---------|-------|
| 28763-6 | 35,72 |
| 28762-9 | 89,32 |
| 48064-8 | 35,72 |
| 48066-2 | 89,32 |
| 48074-7 | 37,26 |
| 48076-1 | 93,26 |

Uebergangsp. 50 x 1,5 mm, Edelstahl matt, gewölbt

connecting profile 50 x 1,5 mm, stainless steel satin, curved

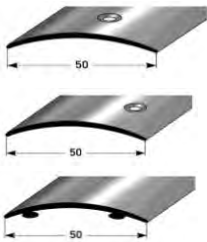

| | | | |
|------------------------------------|-----|---------|-------|
| mittig gebohrt, centrally drilled | 1,0 | 63000-5 | 22,92 |
| mittig gebohrt, centrally drilled | 2,7 | 63005-0 | 61,88 |
| seitlich gebohrt,laterally drilled | 1,0 | 63020-3 | 22,92 |
| seitlich gebohrt,laterally drilled | 2,7 | 63025-8 | 61,88 |
| selbstklebend ,self-adhesive | 1,0 | 63040-1 | 24,84 |
| selbstklebend ,self-adhesive | 2,7 | 63045-6 | 62,12 |

| | |
|---------|-------|
| 63010-4 | 25,14 |
| 63015-9 | 63,86 |
| 63030-2 | 25,14 |
| 63035-7 | 63,86 |
| 63050-0 | 27,02 |
| 63055-5 | 68,68 |

Uebergangsp. 50 x 4 mm, Alu. Elox., mittig geb., stark

connecting profile 50 x 4 mm, aluminium anodized, heavy duty, centrally drilled



| | | | |
|------------------------------|-----|---------|-------|
| silberfarbig silver coloured | 1,0 | 42820-6 | 12,10 |
| silberfarbig silver coloured | 2,7 | 42825-1 | 32,74 |
| goldfarbiggold coloured | 1,0 | 42840-4 | 12,54 |
| goldfarbiggold coloured | 2,7 | 42845-9 | 33,84 |
| bronzef. Hell,bronze light | 1,0 | 42860-2 | 13,38 |
| bronzef. Hell,bronze light | 2,7 | 42865-7 | 36,06 |
| bronzef. Dunkel, bronze dark | 1,0 | 42880-0 | 13,38 |
| bronzef. Dunkel, bronze dark | 2,7 | 42885-5 | 36,06 |

| | |
|---------|-------|
| 42830-5 | 12,92 |
| 42835-0 | 34,96 |
| 42850-3 | 13,36 |
| 42855-8 | 36,00 |
| 42870-1 | 14,54 |
| 42875-6 | 39,32 |
| 42890-9 | 14,20 |
| 42895-4 | 38,24 |

Uebergangsp. 50 x 4 mm, Alu. Elox., seiti. geb., stark

connecting profile 50 x 4 mm, aluminium anodized, heavy duty, laterally drilled

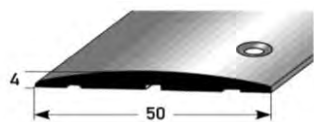

| | | | |
|------------------------------|-----|---------|-------|
| silberfarbig silver coloured | 1,0 | 47818-8 | 12,10 |
| silberfarbig silver coloured | 2,7 | 47820-1 | 32,74 |
| goldfarbiggold coloured | 1,0 | 47826-3 | 12,54 |
| goldfarbiggold coloured | 2,7 | 47828-7 | 33,84 |
| bronzef. Hell,bronze light | 1,0 | 47834-8 | 13,38 |
| bronzef. Hell,bronze light | 2,7 | 47836-2 | 36,06 |
| bronzef. Dunkel, bronze dark | 1,0 | 47842-3 | 13,38 |
| bronzef. Dunkel, bronze dark | 2,7 | 47844-7 | 36,06 |

| | |
|---------|-------|
| 47822-5 | 12,92 |
| 47824-9 | 34,96 |
| 47830-0 | 13,36 |
| 47832-4 | 36,00 |
| 47838-6 | 14,54 |
| 47840-9 | 39,32 |
| 47846-1 | 14,20 |
| 47848-5 | 38,24 |

Uebergangsp. 50 x 4 mm, Alu. Elox., selbstklebend, stark

connecting profile 50 x 4 mm, aluminium anodized, heavy duty, self-adhesive



| | | | |
|------------------------------|-----|---------|-------|
| silberfarbig silver coloured | 1,0 | 47750-1 | 13,94 |
| silberfarbig silver coloured | 2,7 | 47752-5 | 37,70 |
| goldfarbiggold coloured | 1,0 | 47758-7 | 14,40 |
| goldfarbiggold coloured | 2,7 | 47760-0 | 38,80 |
| bronzef. Hell,bronze light | 1,0 | 47766-2 | 15,22 |
| bronzef. Hell,bronze light | 2,7 | 47768-6 | 41,04 |
| bronzef. Dunkel, bronze dark | 1,0 | 47774-7 | 15,22 |
| bronzef. Dunkel, bronze dark | 2,7 | 47776-1 | 41,04 |

| | |
|---------|-------|
| 47754-9 | 14,48 |
| 47756-3 | 39,12 |
| 47762-4 | 14,88 |
| 47764-8 | 40,18 |
| 47770-9 | 16,12 |
| 47772-3 | 43,50 |
| 47778-5 | 16,12 |
| 47780-8 | 43,50 |

4. UeBERGANGSPROFILE/ 4. CONNECTING PROFILES

Andere Eloxalfarben siehe Abschnitt 6, Lieferzeit 14 Tage/
other anodized colours see section 6, delivery time 14 days

| Profi-Pack à 10 StUeck im Bund | | | |
|--------------------------------|-----------|-----------|-------------|
| professional packing à 10 pcs. | | | |
| Farbe/colour | L / l (m) | Art./ref. | €/Stk./pcs. |

| SB-Pack incl. Schr./DUebel; VE 20 Stk. | |
|---|-------------|
| self-service-pack with screws/dowels; à 20 pcs. | |
| Art./ref. | €/Stk./pcs. |

04 Uebergangsprofil 57 x 2 mm, Messing poliert, mit Schutzfolie

connecting profile 57 x 2 mm, brass polished, with protective foil

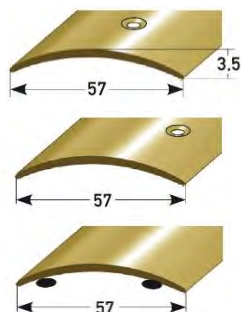

| | | | |
|------------------------------|------------|----------------|--------------|
| mittig geb., centr. drill. | <u>1.0</u> | <u>28771-1</u> | <u>37,28</u> |
| mittig geb., centr. drill. | <u>2.5</u> | <u>28770-4</u> | <u>93,20</u> |
| seitlich geb.,later. drill. | <u>1.0</u> | <u>48080-8</u> | <u>37,28</u> |
| seitlich geb.,later. drill. | <u>2.5</u> | <u>48082-2</u> | <u>93,20</u> |
| selbstklebend ,self-adhesive | <u>1.0</u> | <u>48090-7</u> | <u>39,04</u> |
| selbstklebend ,self-adhesive | <u>2.5</u> | <u>48092-1</u> | <u>97,64</u> |

| | |
|----------------|--------------|
| <u>28773-5</u> | <u>38,24</u> |
| <u>28772-8</u> | <u>95,70</u> |
| <u>48084-6</u> | <u>38,24</u> |
| <u>48086-0</u> | <u>95,70</u> |
| <u>48094-5</u> | <u>39,80</u> |
| <u>48096-9</u> | <u>99,70</u> |

Uebergangsp. 58 x 4 mm, Alu.eloxiert, mittig geb., stark

08

connecting profile 58 x 4 mm, aluminium anodized, heavy duty, centrally drilled



| | | | |
|------------------------------|------------|----------------|--------------|
| silberfarbig silver coloured | <u>1.0</u> | <u>31600-8</u> | <u>13,96</u> |
| silberfarbig silver coloured | <u>2.7</u> | <u>31605-3</u> | <u>37,72</u> |
| goldfarbiggold coloured | <u>1.0</u> | <u>31610-7</u> | <u>14,46</u> |
| goldfarbiggold coloured | <u>2.7</u> | <u>31615-2</u> | <u>39,02</u> |
| bronzef. Hell,bronze light | <u>1.0</u> | <u>31620-6</u> | <u>15,44</u> |
| bronzef. Hell,bronze light | <u>2.7</u> | <u>31625-1</u> | <u>41,64</u> |
| bronzef. Dunkel, bronze dark | <u>1.0</u> | <u>31630-5</u> | <u>15,44</u> |
| bronzef. Dunkel, bronze dark | <u>2.7</u> | <u>31635-0</u> | <u>41,64</u> |

| | |
|----------------|--------------|
| <u>31601-5</u> | <u>14,76</u> |
| <u>31606-0</u> | <u>39,90</u> |
| <u>31611-4</u> | <u>15,28</u> |
| <u>31616-9</u> | <u>41,18</u> |
| <u>31621-3</u> | <u>16,60</u> |
| <u>31626-8</u> | <u>44,84</u> |
| <u>31631-2</u> | <u>16,24</u> |
| <u>31636-7</u> | <u>43,82</u> |

Uebergangsp. 58 x 4 mm, Alu. Elox., seitl. geb., stark

08

connecting profile 58 x 4 mm, aluminium anodized, heavy duty, laterally drilled



| | | | |
|------------------------------|------------|----------------|--------------|
| silberfarbig silver coloured | <u>1.0</u> | <u>47852-2</u> | <u>13,96</u> |
| silberfarbig silver coloured | <u>2.7</u> | <u>47854-6</u> | <u>37,72</u> |
| goldfarbiggold coloured | <u>1.0</u> | <u>47860-7</u> | <u>14,46</u> |
| goldfarbiggold coloured | <u>2.7</u> | <u>47862-1</u> | <u>39,02</u> |
| bronzef. Hell,bronze light | <u>1.0</u> | <u>47868-3</u> | <u>15,44</u> |
| bronzef. Hell,bronze light | <u>2.7</u> | <u>47870-6</u> | <u>41,64</u> |
| bronzef. Dunkel, bronze dark | <u>1.0</u> | <u>47876-8</u> | <u>15,44</u> |
| bronzef. Dunkel, bronze dark | <u>2.7</u> | <u>47878-2</u> | <u>41,64</u> |

| | |
|----------------|--------------|
| <u>47856-0</u> | <u>14,76</u> |
| <u>47858-4</u> | <u>39,90</u> |
| <u>47864-5</u> | <u>15,28</u> |
| <u>47866-9</u> | <u>41,18</u> |
| <u>47872-0</u> | <u>16,60</u> |
| <u>47874-4</u> | <u>44,84</u> |
| <u>47880-5</u> | <u>16,24</u> |
| <u>47882-9</u> | <u>43,82</u> |

Uebergangsp. 58 x 4 mm, Alu. Elox., selbstklebend, stark

08

connecting profile 58 x 4 mm, aluminium anodized, heavy duty, self-adhesive



| | | | |
|------------------------------|------------|----------------|--------------|
| silberfarbig silver coloured | <u>1.0</u> | <u>47784-6</u> | <u>17,36</u> |
| silberfarbig silver coloured | <u>2.7</u> | <u>47786-0</u> | <u>46,86</u> |
| goldfarbiggold coloured | <u>1.0</u> | <u>47792-1</u> | <u>17,86</u> |
| goldfarbiggold coloured | <u>2.7</u> | <u>47794-5</u> | <u>48,18</u> |
| bronzef. Hell,bronze light | <u>1.0</u> | <u>47800-3</u> | <u>18,82</u> |
| bronzef. Hell,bronze light | <u>2.7</u> | <u>47802-7</u> | <u>50,80</u> |
| bronzef. Dunkel, bronze dark | <u>1.0</u> | <u>47808-9</u> | <u>18,82</u> |
| bronzef. Dunkel, bronze dark | <u>2.7</u> | <u>47810-2</u> | <u>50,80</u> |

| | |
|----------------|--------------|
| <u>47788-4</u> | <u>17,58</u> |
| <u>47790-7</u> | <u>47,50</u> |
| <u>47796-9</u> | <u>18,06</u> |
| <u>47798-3</u> | <u>48,76</u> |
| <u>47804-1</u> | <u>19,38</u> |
| <u>47806-5</u> | <u>52,42</u> |
| <u>47812-6</u> | <u>19,38</u> |
| <u>47814-0</u> | <u>52,42</u> |

4. UeBERGANGSPROFILE/ 4. CONNECTING PROFILES

Andere Eloxalfarben siehe
Abschnitt 6, Lieferzeit 14 Tage/

350 anodized colours see section 6,
delivery time 14 days

| Profi-Pack à 10 StUeck im Bund | | | |
|--------------------------------|-----------|-----------|-------------|
| professional packing à 10 pcs. | | | |
| Farbe/colour | L / l (m) | Art./ref. | €/Stk./pcs. |

| SB-Pack incl. Schr./ DUebel; VE 20 Stk. | |
|---|-------------|
| self-service-pack with screws/ dowels; à 20 pcs. | |
| Art./ref. | €/Stk./pcs. |

Uebergangsp. 58 x 3,5mm, Alu.eloxiert, mittig geb., stark

connecting profile 80 x 3,5 mm,
aluminium anodized,
centrally drilled

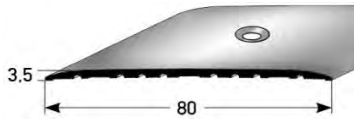

350

| | | | |
|------------------------------|------------|----------------|--------------|
| silberfarbig silver coloured | <u>1,0</u> | <u>65400-1</u> | <u>15,64</u> |
| silberfarbig silver coloured | <u>2,7</u> | <u>65402-5</u> | <u>42,20</u> |
| goldfarbiggold coloured | <u>1,0</u> | <u>65404-9</u> | <u>15,98</u> |
| goldfarbiggold coloured | <u>2,7</u> | <u>65406-3</u> | <u>43,14</u> |
| bronzef. Hell,bronze light | <u>1,0</u> | <u>65408-7</u> | <u>17,82</u> |
| bronzef. Hell,bronze light | <u>2,7</u> | <u>65410-0</u> | <u>48,06</u> |
| bronzef. Dunkel, bronze dark | <u>1,0</u> | <u>65412-4</u> | <u>17,82</u> |
| bronzef. Dunkel, bronze dark | <u>2,7</u> | <u>65414-8</u> | <u>48,06</u> |

| | |
|----------------|--------------|
| <u>65416-2</u> | <u>16,42</u> |
| <u>65418-6</u> | <u>44,56</u> |
| <u>65420-9</u> | <u>16,76</u> |
| <u>65422-3</u> | <u>45,50</u> |
| <u>65424-7</u> | <u>18,58</u> |
| <u>65426-1</u> | <u>50,44</u> |
| <u>65428-5</u> | <u>18,58</u> |
| <u>65430-8</u> | <u>50,44</u> |

Uebergangsp. 80 x 3,5 mm, Alu. Elox., seitl. geb.

connecting profile 80 x 3,5 mm,
aluminium anodized,
laterally drilled

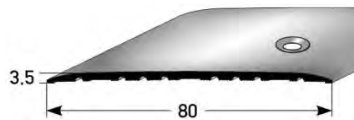

350

| | | | |
|------------------------------|------------|----------------|--------------|
| silberfarbig silver coloured | <u>1,0</u> | <u>65434-6</u> | <u>15,64</u> |
| silberfarbig silver coloured | <u>2,7</u> | <u>65436-0</u> | <u>42,20</u> |
| goldfarbiggold coloured | <u>1,0</u> | <u>65438-4</u> | <u>15,98</u> |
| goldfarbiggold coloured | <u>2,7</u> | <u>65440-7</u> | <u>43,14</u> |
| bronzef. Hell,bronze light | <u>1,0</u> | <u>65442-1</u> | <u>17,82</u> |
| bronzef. Hell,bronze light | <u>2,7</u> | <u>65444-5</u> | <u>48,06</u> |
| bronzef. Dunkel, bronze dark | <u>1,0</u> | <u>65446-9</u> | <u>17,82</u> |
| bronzef. Dunkel, bronze dark | <u>2,7</u> | <u>65448-3</u> | <u>48,06</u> |

| | |
|----------------|--------------|
| <u>65450-6</u> | <u>16,42</u> |
| <u>65452-0</u> | <u>44,56</u> |
| <u>65454-4</u> | <u>16,76</u> |
| <u>65456-8</u> | <u>45,50</u> |
| <u>65458-2</u> | <u>18,58</u> |
| <u>65460-5</u> | <u>50,44</u> |
| <u>65462-9</u> | <u>18,58</u> |
| <u>65464-3</u> | <u>50,44</u> |

Uebergangsp. 80 x 3,5 mm, Alu. Elox., selbstklebend

connecting profile 80 x 3,5 mm,
aluminium anodized,
self-adhesive

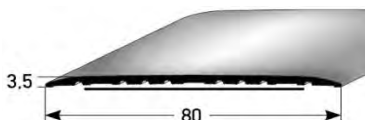

| | | | |
|------------------------------|------------|----------------|--------------|
| silberfarbig silver coloured | <u>1,0</u> | <u>65468-1</u> | <u>18,92</u> |
| silberfarbig silver coloured | <u>2,7</u> | <u>65470-4</u> | <u>51,10</u> |
| goldfarbiggold coloured | <u>1,0</u> | <u>65472-8</u> | <u>19,28</u> |
| goldfarbiggold coloured | <u>2,7</u> | <u>65474-2</u> | <u>52,06</u> |
| bronzef. Hell,bronze light | <u>1,0</u> | <u>65476-6</u> | <u>21,10</u> |
| bronzef. Hell,bronze light | <u>2,7</u> | <u>65478-0</u> | <u>56,98</u> |
| bronzef. Dunkel, bronze dark | <u>1,0</u> | <u>65480-3</u> | <u>21,10</u> |
| bronzef. Dunkel, bronze dark | <u>2,7</u> | <u>65482-7</u> | <u>56,98</u> |

| | |
|----------------|--------------|
| <u>65484-1</u> | <u>19,40</u> |
| <u>65486-5</u> | <u>52,56</u> |
| <u>65488-9</u> | <u>19,76</u> |
| <u>65490-2</u> | <u>53,50</u> |
| <u>65492-6</u> | <u>21,58</u> |
| <u>65494-0</u> | <u>58,42</u> |
| <u>65496-4</u> | <u>21,58</u> |
| <u>65498-8</u> | <u>58,42</u> |

wechselseitig gebohrt auf Anfrage

alternating sides drilled on reqUest

4. Uebergangsp. / 4. CONNECTING PROFILES

439

| Profi-Pack à 10 Stueck im Bund | | | | SB-Pack incl. Schr./ DUEbel; VE 20 Stk. | |
|--------------------------------|-----------|-----------|-------------|--|-------------|
| professional packing à 10 pcs. | | | | self-service-pack with screws/ dowels; à 20 pcs. | |
| Befestigung/fixing | L / l (m) | Art./ref. | €/Stk./pcs. | Art./ref. | €/Stk./pcs. |

Edelst.-Uebergangsp.27 x 1,5 mm, profil. Riffelung, matt

stainless steel connecting profile 27 x 1,8 mm, fluted profile, satin

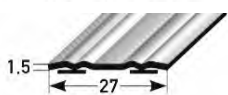
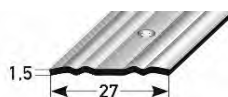

| | | | | | |
|------------------------------------|---------------------|-------------------------|-----------------------|-------------------------|-----------------------|
| mittig gebohrt , centrally drilled | 1,0 | 68270-7 | 9,82 | 68282-0 | 10,62 |
| mittig gebohrt , centrally drilled | 2,7 | 68272-1 | 26,52 | 68284-4 | 28,68 |
| selbstklebend,self-adhesive | 1,0 | 68276-9 | 11,28 | 68288-2 | 11,88 |
| selbstklebend,self-adhesive | 2,7 | 68278-3 | 30,48 | 68290-5 | 32,64 |

440

Edelst.-Uebergangsp.38x 1,5 mm, profil. Riffelung, matt

stainless steel connecting profile 38 x 1,8 mm, fluted profile, satin

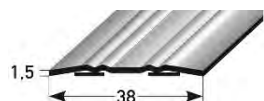
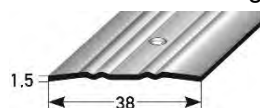

| | | | | | |
|------------------------------------|---------------------|-------------------------|-----------------------|-------------------------|-----------------------|
| mittig gebohrt , centrally drilled | 1,0 | 68300-1 | 12,06 | 68312-4 | 12,86 |
| mittig gebohrt , centrally drilled | 2,7 | 68302-5 | 32,58 | 68314-8 | 34,74 |
| selbstklebend,self-adhesive | 1,0 | 68306-3 | 13,56 | 68318-6 | 14,14 |
| selbstklebend,self-adhesive | 2,7 | 68308-7 | 36,56 | 68320-9 | 38,16 |

441

Uebergangsp. 30 x 3,5 mm, Edelst.V4A gezogen, geb.

drawn stainless steel connecting profile V4A 30 x 3,5 mm, drilled

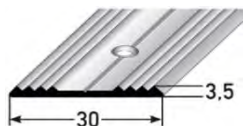

| | | | | | |
|------------------------------------|---------------------|-------------------------|------------------------|-------------------------|------------------------|
| mittig gebohrt , centrally drilled | 1,0 | 68330-8 | 60,12 | 68336-0 | 62,24 |
| mittig gebohrt , centrally drilled | 2,5 | 68332-2 | 150,32 | 68338-4 | 156,64 |

Edelstahlschrauben siehe Abschnitt 12/
stainless steel screws see section 12

412

Uebergangsp.70 x 1,5 mm, Edelst. matt, geb.

connecting profile INOX PROTECT 70 x 1,5 mm, stainless steel satin, drilled

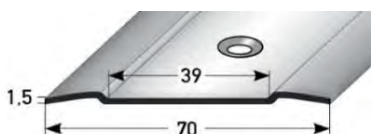

| Edelstahl-Uebergangsp. INOX PROTECT | | | | zur | |
|--|-----------|-----------|-------------|-----|--|
| Verlegung mit Einlage 39 mm | | | | | |
| stainless steel connecting profiles for installation with insert 39 mm | | | | | |
| Befestigung/fixing | L / l (m) | Art./ref. | €/Stk./pcs. | | |

| | | | | | |
|------------------------------------|-----------------------|-------------------------|-----------------------|--|--|
| mittig gebohrt , centrally drilled | 1,0 m | 67034-6 | 32,08 | | |
| mittig gebohrt , centrally drilled | 2,5 m | 67036-0 | 80,18 | | |
| mittig gebohrt , centrally drilled | 3,0 m | 67038-4 | 96,26 | | |

fUr Verlegung mit Einlage 39 mm, siehe Seite 22
installation with insert 39 mm, see page 22

for

3,0 m-Ware ist nur per Spedition lieferbar
(gesonderte Transportkosten)
3,0 m profiles are only available per forwarding agency
(separate transport costs)

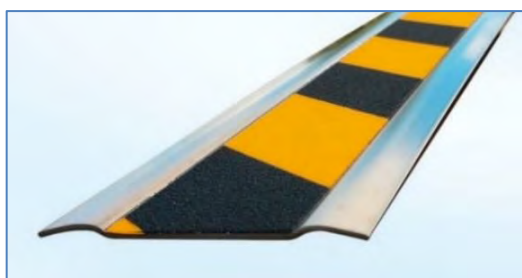

Uebergangsp. INOX PROTECT mit Einlage 39 mm, Easy-Clean, schwarz/ gelb (siehe oben bzw. Seite 22)
connecting profile INOX PROTECT with insert 39 mm, Easy-Clean, black/ yellow (see above and at page 22)

4. UEBERGANGSPROFILE/ 4. CONNECTING PROFILES

Andere Eloxalfarben siehe Abschnitt 6, Lieferzeit 14 Tage/
other anodized colours see section 6, delivery time 14 days

| Profi-Pack à 10 StUeck im Bund | | | | |
|--------------------------------|-----|-----------|-----------|-------------|
| professional packing à 10 pcs. | | | | |
| Farbe/colour | 0 9 | L / l (m) | Art./ref. | €/Stk./pcs. |

| SB-Pack incl. Schr./ DUEbel; VE 20 Stk. | |
|--|-------------|
| self-service-pack with screws/ dowels; à 20 pcs. | |
| Art./ref. | €/Stk./pcs. |

Abschlussp.30 x 4,5 mm, Alu. eloxiert, geb.

adaptation profile 30 x 4,5 mm, aluminium anodized, drilled

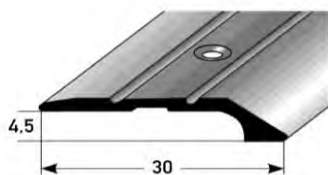

| | | | |
|-------------------|---------|--------|-------|
| silver coloured | 0.9 | 8090-9 | 5,48 |
| silver coloured | 1.0 | 8100-5 | 6,12 |
| silver coloured | 2.7 | 8110-4 | 16,44 |
| gold coloured | 0.9 | 8190-6 | 5,56 |
| gold coloured | 1.0 | 8200-2 | 6,22 |
| gold coloured | 2.7 | 8210-1 | 16,78 |
| bronze light col. | 0.9 | 8290-3 | 5,80 |
| bronze light col. | 1.0 | 8300-9 | 6,44 |
| bronze light col. | 2.7 | 8310-8 | 17,36 |
| bronze dark col. | 0.9 | 8390-0 | 5,80 |
| bronze dark col. | 1.0 | 8400-6 | 6,44 |
| bronze dark col. | 0 9 2.7 | 8410-5 | 17,36 |

| | |
|--------|-------|
| 8091-6 | 6,22 |
| 8101-2 | 6,90 |
| 8111-1 | 18,66 |
| 8191-3 | 6,30 |
| 8201-9 | 7,00 |
| 8211-8 | 18,92 |
| 8291-0 | 6,84 |
| 8301-6 | 7,60 |
| 8311-5 | 20,58 |
| 8391-7 | 6,52 |
| 8401-3 | 7,22 |
| 8411-2 | 19,50 |

Abschlussp. 30 x 4,5 mm, Alu. eloxiert, selbstkl.

adaptation profile 30 x 4,5 mm, aluminium anodized, self-adhesive

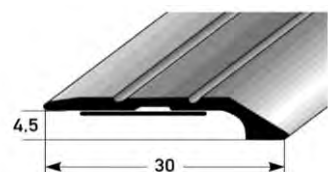

| | | | |
|-------------------|-----|--------|-------|
| silver coloured | 0.9 | 8093-0 | 7,16 |
| silver coloured | 1.0 | 8103-6 | 7,96 |
| silver coloured | 2.7 | 8113-5 | 21,40 |
| gold coloured | 0.9 | 8193-7 | 7,26 |
| gold coloured | 1.0 | 8203-3 | 8,06 |
| gold coloured | 2.7 | 8213-2 | 21,76 |
| bronze light col. | 0.9 | 8293-4 | 7,42 |
| bronze light col. | 1.0 | 8303-0 | 8,24 |
| bronze light col. | 2.7 | 8313-9 | 22,30 |
| bronze dark col. | 0.9 | 8393-1 | 7,42 |
| bronze dark col. | 1.0 | 8403-7 | 8,24 |
| bronze dark col. | 2.7 | 8413-6 | 22,30 |

| | |
|--------|-------|
| 8092-3 | 7,60 |
| 8102-9 | 8,42 |
| 8112-8 | 22,82 |
| 8192-0 | 7,70 |
| 8202-6 | 8,60 |
| 8212-5 | 23,16 |
| 8292-7 | 7,96 |
| 8302-3 | 8,80 |
| 8312-2 | 23,74 |
| 8392-4 | 7,96 |
| 8402-0 | 8,80 |
| 8412-9 | 23,74 |

Anpassungsp.40 mm, 2 bis 16 mm, Alu.elox., geb.

levelling profile 40 mm, height compensation 2-16 mm, aluminium anodized, drilled

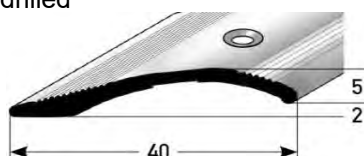

| | | | |
|------------------------------|---------|---------|-------|
| silberfarbig silver coloured | 1.0 | 66116-0 | 8,76 |
| silberfarbig silver coloured | 2.7 | 66118-4 | 23,66 |
| goldfarbiggold coloured | 1.0 | 66120-7 | 9,00 |
| goldfarbiggold coloured | 2.7 | 66122-1 | 24,30 |
| bronzef. Hell,bronze light | 1.0 | 66124-5 | 9,80 |
| bronzef. Hell,bronze light | 2.7 | 66126-9 | 26,46 |
| bronzef. Dunkel, bronze dark | 1.0 | 66128-3 | 9,80 |
| bronzef. Dunkel, bronze dark | 349 2.7 | 66130-6 | 26,46 |

| | |
|---------|-------|
| 66136-8 | 9,54 |
| 66138-2 | 26,04 |
| 66140-5 | 9,80 |
| 66142-9 | 26,66 |
| 66144-3 | 10,98 |
| 66146-7 | 30,02 |
| 66148-1 | 10,60 |
| 66150-4 | 28,82 |

Anpassungsp.40 mm, 2 bis 16 mm, Alu.elox., selbstkl.

levelling profile 40 mm, height compensation 2-16 mm, aluminium anodized, self-adhesive

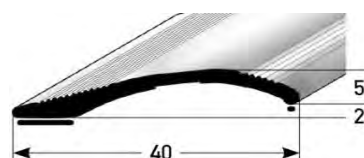

| | | | |
|------------------------------|-----|---------|-------|
| silberfarbig silver coloured | 1.0 | 66158-0 | 10,58 |
| silberfarbig silver coloured | 2.7 | 66160-3 | 28,54 |
| goldfarbiggold coloured | 1.0 | 66162-7 | 10,80 |
| goldfarbiggold coloured | 2.7 | 66164-1 | 29,16 |
| bronzef. Hell,bronze light | 1.0 | 66166-5 | 11,60 |
| bronzef. Hell,bronze light | 2.7 | 66168-9 | 31,32 |
| bronzef. Dunkel, bronze dark | 1.0 | 66170-2 | 11,60 |
| bronzef. Dunkel, bronze dark | 2.7 | 66172-6 | 31,32 |

| | |
|---------|-------|
| 66178-8 | 11,06 |
| 66180-1 | 29,98 |
| 66182-5 | 11,28 |
| 66184-9 | 30,60 |
| 66186-3 | 12,08 |
| 66188-7 | 32,78 |
| 66190-0 | 12,08 |
| 66192-4 | 32,78 |

4. UEBERGANGSPROFILE/ 4. CONNECTING PROFILES

Andere Eloxalfarben siehe
Abschnitt 6, Lieferzeit 14 Tage/
other anodized colours see section 6,
delivery time 14 days

| Profi-Pack à 10 StUeck im Bund | | | |
|--------------------------------|-----------|-----------|-------------|
| professional pack 132 0 pcs. | | | |
| Farbe/colour | L / l (m) | Art./ref. | €/Stk./pcs. |

| SB-Pack incl. Schr./ DUebel; VE 20 Stk. | |
|---|-------------|
| self-service-pack with screws/ dowels; à 20 pcs. | |
| Art./ref. | €/Stk./pcs. |

Abschlussp. Laminat, 34 x 8,5 mm, Alu. Elox., geb.

adaptation profile for laminate,
34 x 8,5 mm, aluminium
anodized, drilled

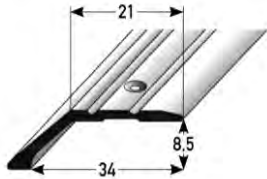

| | | | | | |
|------------------------------|-----|---------|-------|---------|-------|
| silberfarbig silver coloured | 1,0 | 41580-0 | 8,00 | 41581-7 | 8,82 |
| silberfarbig silver coloured | 2,7 | 41590-9 | 21,50 | 41591-6 | 23,78 |
| goldfarbiggold coloured | 1,0 | 41600-5 | 8,20 | 41601-2 | 9,02 |
| goldfarbiggold coloured | 2,7 | 41610-4 | 22,16 | 41611-1 | 24,40 |
| bronzef. Hell,bronze light | 1,0 | 41620-3 | 8,92 | 41621-0 | 10,14 |
| bronzef. Hell,bronze light | 2,7 | 41630-2 | 24,06 | 41631-9 | 27,32 |
| bronzef. Dunkel, bronze dark | 1,0 | 41640-1 | 8,92 | 41641-8 | 9,74 |
| bronzef. Dunkel, bronze dark | 2,7 | 41650-0 | 24,06 | 41651-7 | 26,32 |
| gold hell, gold light | 1,0 | 62245-1 | 8,20 | 62255-0 | 9,02 |
| gold hell, gold light | 2,7 | 62250-5 | 22,16 | 62260-4 | 24,40 |

Abschlussp. Laminat, 34 x 8,5 mm, Alu. Elox., selbstkl.

adaptation profile for laminate,
34 x 8,5 mm, aluminium
anodized, self-adhesive

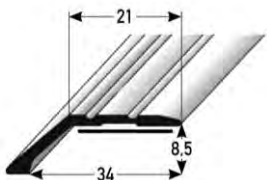

| | | | | | |
|------------------------------|-----|---------|-------|---------|-------|
| silberfarbig silver coloured | 1,0 | 47922-2 | 9,44 | 47926-0 | 10,26 |
| silberfarbig silver coloured | 2,7 | 47924-6 | 25,52 | 47928-4 | 27,32 |
| goldfarbiggold coloured | 1,0 | 47930-7 | 9,68 | 47934-5 | 10,36 |
| goldfarbiggold coloured | 2,7 | 47932-1 | 26,06 | 47936-9 | 27,90 |
| bronzef. Hell,bronze light | 1,0 | 47938-3 | 10,36 | 47942-0 | 10,98 |
| bronzef. Hell,bronze light | 2,7 | 47940-6 | 27,98 | 47944-4 | 29,80 |
| bronzef. Dunkel, bronze dark | 1,0 | 47946-8 | 10,36 | 47950-5 | 10,98 |
| bronzef. Dunkel, bronze dark | 2,7 | 47948-2 | 27,98 | 47952-9 | 29,80 |
| gold hell, gold light | 1,0 | 48100-3 | 9,68 | 48104-1 | 10,28 |
| gold hell, gold light | 2,7 | 48102-7 | 26,06 | 48106-5 | 27,90 |

Abschlussp. Parkett, 47 x 15,5 mm, Alu. Elox., geb.

adaptation profile for wooden
floor, 47 x 15,5 mm, aluminium
anodized, drilled

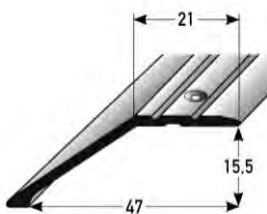

| | | | | | |
|------------------------------|-----|---------|-------|---------|-------|
| silberfarbig silver coloured | 1,0 | 41660-9 | 10,32 | 41661-6 | 11,16 |
| silberfarbig silver coloured | 2,7 | 41670-8 | 27,84 | 41671-5 | 30,10 |
| goldfarbiggold coloured | 1,0 | 41680-7 | 10,68 | 41681-4 | 11,50 |
| goldfarbiggold coloured | 2,7 | 41690-6 | 28,84 | 41691-3 | 31,08 |
| bronzef. Hell,bronze light | 1,0 | 41700-2 | 11,62 | 41701-9 | 12,78 |
| bronzef. Hell,bronze light | 2,7 | 41710-1 | 31,36 | 41711-8 | 34,56 |
| bronzef. Dunkel, bronze dark | 1,0 | 41720-0 | 11,62 | 41721-7 | 12,44 |
| bronzef. Dunkel, bronze dark | 2,7 | 41730-9 | 31,36 | 41731-6 | 33,56 |
| gold hell, gold light | 1,0 | 62275-8 | 10,68 | 62285-7 | 11,50 |
| gold hell, gold light | 2,7 | 62280-2 | 28,84 | 62290-1 | 31,08 |

Abschlussp. Parkett, 47 x 15,5 mm, Alu. Elox., selbstkl.

adaptation profile for wooden
floor, 47 x 15,5 mm, aluminium
anodized, self-adhesive

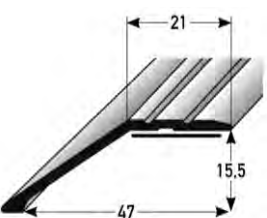

| | | | | | |
|------------------------------|-----|---------|-------|---------|-------|
| silberfarbig silver coloured | 1,0 | 47956-7 | 11,76 | 47960-4 | 12,38 |
| silberfarbig silver coloured | 2,7 | 47958-1 | 31,76 | 47962-8 | 33,58 |
| goldfarbiggold coloured | 1,0 | 47964-2 | 12,12 | 47968-0 | 12,74 |
| goldfarbiggold coloured | 2,7 | 47966-6 | 32,78 | 47970-3 | 34,58 |
| bronzef. Hell,bronze light | 1,0 | 47972-7 | 13,08 | 47976-5 | 14,52 |
| bronzef. Hell,bronze light | 2,7 | 47974-1 | 35,30 | 47978-9 | 37,12 |
| bronzef. Dunkel, bronze dark | 1,0 | 47980-2 | 13,08 | 47984-0 | 14,52 |
| bronzef. Dunkel, bronze dark | 2,7 | 47982-6 | 35,30 | 47986-4 | 37,12 |
| gold hell, gold light | 1,0 | 48110-2 | 12,12 | 48114-0 | 12,74 |
| gold hell, gold light | 2,7 | 48112-6 | 32,78 | 48116-4 | 34,58 |



4. UEBERGANGSPROFILE/ 4. CONNECTING PROFILES

Andere Eloxalfarben siehe
Abschnitt 6, Lieferzeit 14 Tage/
other anodized colours see section 6,
delivery time 14 days

Sockelprofil 8 x 18,4 mm, Wandabschl., Alu. Elox., selbstkl.

plinth profile 8 x 18,4 mm,
as wall edging,
aluminium anodized,
self-adhesive

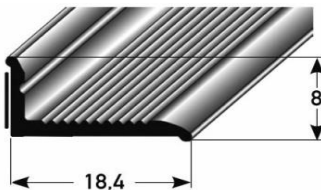

| SB-Pack à 20 StUeck | | | | |
|-----------------------------|-----|-----------|-----------|-------------|
| self-service-pack à 20 pcs. | | | | |
| Farbe/colour | 137 | L / l (m) | Art./ref. | €/Stk./pcs. |

| | | | | |
|-------------------------------------|----------------------------|-------------------------|-------------------------|-----------------------|
| silberfarbig silver coloured | 0,9 | 41741-5 | 7,16 | |
| silberfarbig silver coloured | 2,7 | 41751-4 | 21,46 | |
| goldfarbiggold coloured | 0,9 | 41761-3 | 7,28 | |
| goldfarbiggold coloured | 2,7 | 41771-2 | 21,84 | |
| bronzef. Hell,bronze light | 0,9 | 41781-1 | 9,08 | |
| bronzef. Hell,bronze light | 2,7 | 41791-0 | 27,28 | |
| edelst.farb.,stainless steel col. | 0,9 | 41800-9 | 7,64 | |
| edelst.farb.,stainless steel col. | 2,7 | 41810-8 | 22,96 | |
| gold hell , gold light | 0,9 | 62080-8 | 7,28 | |
| gold hell , gold light | 2,7 | 62085-3 | 21,84 | |
| weiß pulverbe.t,white powder coated | 0,9 | 62090-7 | 8,20 | |
| weiß pulverbe.t,white powder coated | 2,7 | 62095-2 | 24,60 | |
| Holzdekorfolie/ wood decor | Buche, beech | 0,9 | 41821-4 | 12,94 |
| | Buche, beech | 2,7 | 41831-3 | 38,88 |
| | Eiche, oak | 0,9 | 41841-2 | 12,94 |
| | Eiche, oak | 2,7 | 41851-1 | 38,88 |
| | Ahorn,maple | 0,9 | 41861-0 | 12,94 |
| | Ahorn,maple | 2,7 | 41871-9 | 38,88 |
| | Kirschbaum,cherry wood | 0,9 | 41844-3 | 12,94 |
| | Kirschbaum,cherry wood | 2,7 | 41854-2 | 38,88 |
| | Eiche rustikal ,rustic oak | 0,9 | 41864-1 | 12,94 |
| | Eiche rustikal ,rustic oak | 2,7 | 41874-0 | 38,88 |

5. EINSCHUB- & ANSTOßPROFILE AUS ALUMINIUM

5. INSERT PROFILES OUT OF ALUMINIUM

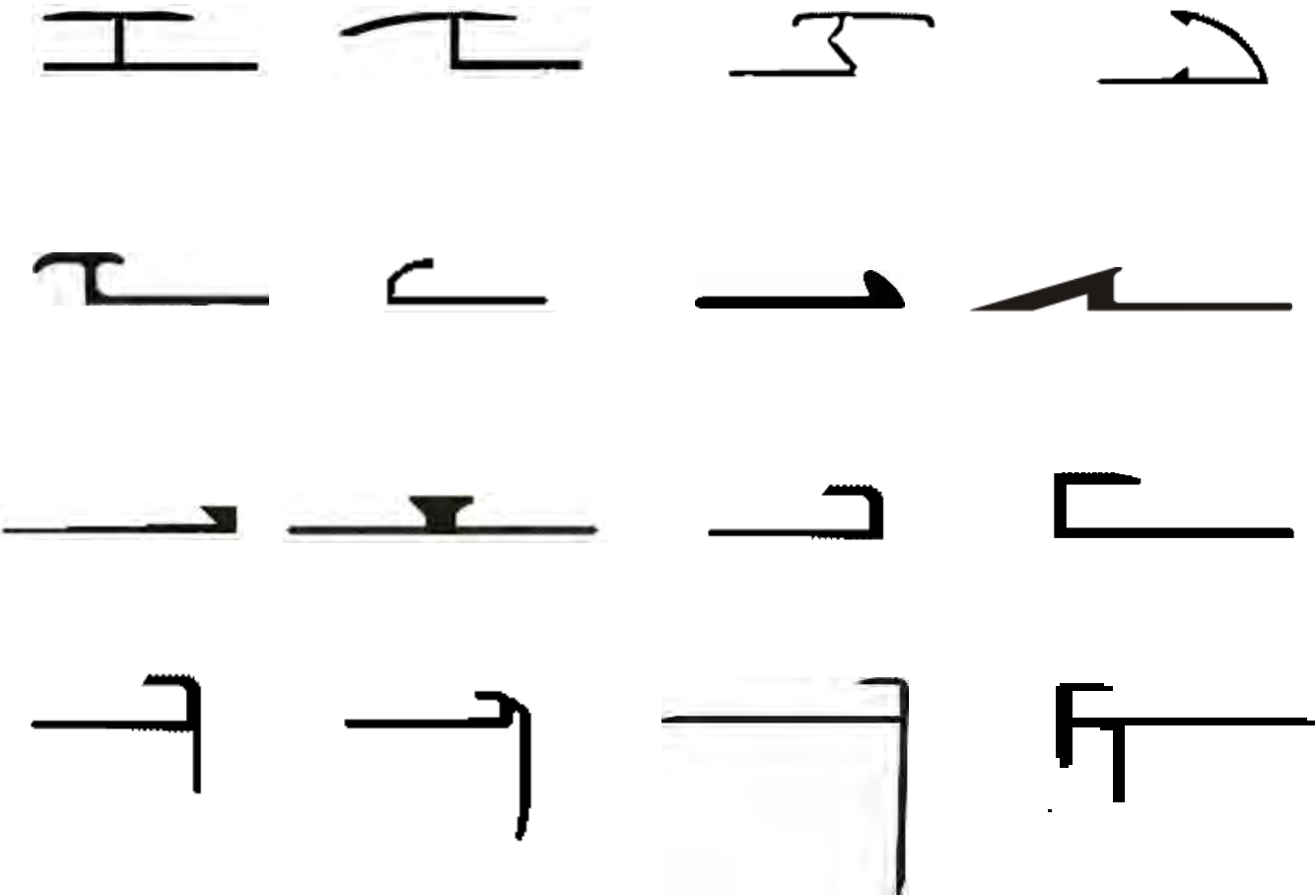

5. EINSCHUB- & ANSTOßPROFILE/ 5. INSERT PROFILES

Andere Eloxalfarben siehe Abschnitt 6, Lieferzeit 14 Tage/
other anodized colours see section 6, delivery time 14 days

| Profi-Pack à 10 StUeck im Bund | | | |
|--------------------------------|-----------|-----------|-------------|
| professional packing à 10 pcs. | | | |
| Farbe/colour | L / l (m) | Art./ref. | €/Stk./pcs. |

| SB-Pack incl. Schr./DUebel; VE 20 Stk. | |
|---|-------------|
| self-service-pack with screws/dowels; à 20 pcs. | |
| Art./ref. | €/Stk./pcs. |

348 Doppeleinschubpr. 14 x 3 mm, Alu. Elox., geb.

double insert profile 14 x 3 mm, aluminium anodized, drilled

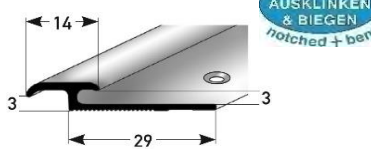

| | | | |
|------------------------------|-----|---------|-------|
| silberfarbig silver coloured | 1,0 | 65948-8 | 7,02 |
| silberfarbig silver coloured | 2,7 | 65950-1 | 18,94 |
| goldfarbiggold coloured | 1,0 | 65952-5 | 7,28 |
| goldfarbiggold coloured | 2,7 | 65954-9 | 19,68 |
| bronzef. Hell,bronze light | 1,0 | 65956-3 | 8,16 |
| bronzef. Hell,bronze light | 2,7 | 65958-7 | 22,04 |
| bronzef. Dunkel, bronze dark | 1,0 | 65960-0 | 8,16 |
| bronzef. Dunkel, bronze dark | 2,7 | 65962-4 | 22,04 |

| | |
|---------|-------|
| 65968-6 | 7,78 |
| 65970-9 | 21,26 |
| 65972-3 | 8,06 |
| 65974-7 | 21,98 |
| 65976-1 | 8,94 |
| 65978-5 | 24,36 |
| 65980-8 | 8,94 |
| 65982-2 | 24,36 |

347 Doppeleinschubpr. 14 x 5 mm, Alu. Elox., geb.

double insert profile 14 x 5 mm, aluminium anodized, drilled

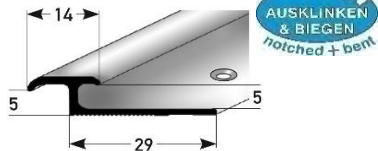

| | | | |
|------------------------------|-----|---------|-------|
| silberfarbig silver coloured | 1,0 | 65990-7 | 7,24 |
| silberfarbig silver coloured | 2,7 | 65992-1 | 19,56 |
| goldfarbiggold coloured | 1,0 | 65994-5 | 7,52 |
| goldfarbiggold coloured | 2,7 | 65996-9 | 20,26 |
| bronzef. Hell,bronze light | 1,0 | 65998-3 | 8,44 |
| bronzef. Hell,bronze light | 2,7 | 66000-2 | 22,76 |
| bronzef. Dunkel, bronze dark | 1,0 | 66002-6 | 8,44 |
| bronzef. Dunkel, bronze dark | 2,7 | 66004-0 | 22,76 |

| | |
|---------|-------|
| 66010-1 | 8,02 |
| 66012-5 | 21,86 |
| 66014-9 | 8,26 |
| 66016-3 | 22,58 |
| 66018-7 | 9,18 |
| 66020-0 | 25,08 |
| 66022-4 | 9,18 |
| 66024-8 | 25,08 |

346 Doppeleinschubpr. 14 x 7 mm, Alu. Elox., geb.

double insert profile 14 x 7 mm, aluminium anodized, drilled

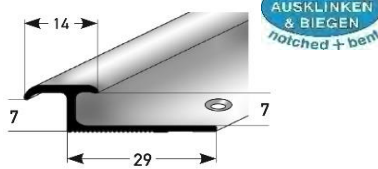

| | | | |
|------------------------------|-----|---------|-------|
| silberfarbig silver coloured | 1,0 | 66074-3 | 7,48 |
| silberfarbig silver coloured | 2,7 | 66076-7 | 20,20 |
| goldfarbiggold coloured | 1,0 | 66078-1 | 7,76 |
| goldfarbiggold coloured | 2,7 | 66080-4 | 20,98 |
| bronzef. Hell,bronze light | 1,0 | 66082-8 | 8,72 |
| bronzef. Hell,bronze light | 2,7 | 66084-2 | 23,60 |
| bronzef. Dunkel, bronze dark | 1,0 | 66086-6 | 8,72 |
| bronzef. Dunkel, bronze dark | 2,7 | 66088-0 | 23,60 |

| | |
|---------|-------|
| 66094-1 | 8,24 |
| 66096-5 | 22,52 |
| 66098-9 | 8,54 |
| 66100-9 | 23,28 |
| 66102-3 | 9,50 |
| 66104-7 | 25,92 |
| 66106-1 | 9,50 |
| 66108-5 | 25,92 |



| | | |
|---|---------------------------|------|
| Befestigungsschenkel ausklinken attachment flanges notched | Art./ref. | €/m |
| Befestigungsschenkel ausklinken und biegen attachment flanges notched and bent | 22240-8 | 5,72 |
| | auf Anfrage on reqUest | |

130 Laminate-Uebergang einteilig 27 x 8,3 x 38 mm, Aluminium eloxiert, gebohrt

laminat edge profile 27 x 8,3 x 38 mm, one-piece, aluminium anodized, drilled

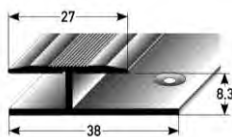

| | | | |
|------------------------------|-----|---------|-------|
| silberfarbig silver coloured | 1,0 | 41500-8 | 11,54 |
| silberfarbig silver coloured | 2,7 | 41510-7 | 31,18 |
| goldfarbiggold coloured | 1,0 | 41520-6 | 12,06 |
| goldfarbiggold coloured | 2,7 | 41530-5 | 32,54 |
| bronzef. Hell,bronze light | 1,0 | 41540-4 | 13,18 |
| bronzef. Hell,bronze light | 2,7 | 41550-3 | 35,60 |
| bronzef. Dunkel, bronze dark | 1,0 | 41560-2 | 13,18 |
| bronzef. Dunkel, bronze dark | 2,7 | 41570-1 | 35,60 |

| | |
|---------|-------|
| 41501-5 | 12,40 |
| 41511-4 | 33,40 |
| 41521-3 | 12,86 |
| 41531-2 | 34,78 |
| 41541-1 | 14,02 |
| 41551-0 | 37,82 |
| 41561-9 | 14,02 |
| 41571-8 | 37,82 |

Laminat Anp. alu .geb. 33 x 8,3 x 45 mm, 131

laminat height levelling 33 x 8,3 x 45 mm, one-piece, aluminium anodized, drilled

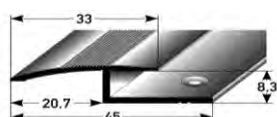

| | | | |
|------------------------------|-----|---------|-------|
| silberfarbig silver coloured | 1,0 | 41420-9 | 10,94 |
| silberfarbig silver coloured | 2,7 | 41430-8 | 29,48 |
| goldfarbiggold coloured | 1,0 | 41440-7 | 11,36 |
| goldfarbiggold coloured | 2,7 | 41450-6 | 30,70 |
| bronzef. Hell,bronze light | 1,0 | 41460-5 | 12,44 |
| bronzef. Hell,bronze light | 2,7 | 41470-4 | 33,58 |
| bronzef. Dunkel, bronze dark | 1,0 | 41480-3 | 12,44 |
| bronzef. Dunkel, bronze dark | 2,7 | 41490-2 | 33,58 |

| | |
|---------|-------|
| 41421-6 | 11,76 |
| 41431-5 | 31,72 |
| 41441-4 | 12,16 |
| 41451-3 | 32,92 |
| 41461-2 | 13,24 |
| 41471-1 | 35,84 |
| 41481-0 | 13,24 |
| 41491-9 | 35,84 |

5. EINSCHUB- & ANSTOßPROFILE/ 5. INSERT PROFILES

Andere Eloxalfarben siehe Abschnitt 6, Lieferzeit 14 Tage/ modified colours see section 6, delivery time 14 days

20

| Profi-Pack à 10 StUeck im Bund | | | |
|--------------------------------|-----------|-----------|-------------|
| professional packing à 10 pcs. | | | |
| Farbe/colour | L / l (m) | Art./ref. | €/Stk./pcs. |

| SB-Pack incl. Schr./ DUebel; VE 20 Stk. | |
|--|-------------|
| self-service-pack with screws/ dowels; à 20 pcs. | |
| Art./ref. | €/Stk./pcs. |

Doppelklemmprofil, Aluminium eloxiert, gebohrt

double jam profile, aluminium anodized, drilled

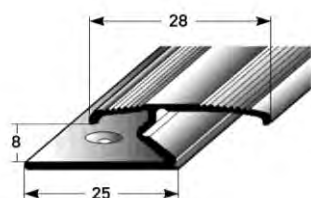

19

| | | | |
|-------------------|------------|----------------|--------------|
| silver coloured | <u>0,9</u> | <u>25090-6</u> | <u>7,20</u> |
| silver coloured | <u>1,0</u> | <u>25100-2</u> | <u>8,02</u> |
| silver coloured | <u>2,7</u> | <u>25110-1</u> | <u>21,58</u> |
| gold coloured | <u>0,9</u> | <u>25190-3</u> | <u>7,34</u> |
| gold coloured | <u>1,0</u> | <u>25200-9</u> | <u>8,16</u> |
| gold coloured | <u>2,7</u> | <u>25210-8</u> | <u>22,04</u> |
| bronze light col. | <u>0,9</u> | <u>25290-0</u> | <u>8,60</u> |
| bronze light col. | <u>1,0</u> | <u>25300-6</u> | <u>9,54</u> |
| bronze light col. | <u>2,7</u> | <u>25310-5</u> | <u>25,72</u> |
| bronze dark col. | <u>0,9</u> | <u>25390-7</u> | <u>8,60</u> |
| bronze dark col. | <u>1,0</u> | <u>25400-3</u> | <u>9,54</u> |
| bronze dark col. | <u>2,7</u> | <u>25410-2</u> | <u>25,72</u> |

| | |
|----------------|--------------|
| <u>25091-3</u> | <u>7,96</u> |
| <u>25101-9</u> | <u>8,82</u> |
| <u>25111-8</u> | <u>23,80</u> |
| <u>25191-0</u> | <u>8,08</u> |
| <u>25201-6</u> | <u>8,96</u> |
| <u>25211-5</u> | <u>24,26</u> |
| <u>25291-7</u> | <u>9,32</u> |
| <u>25301-3</u> | <u>10,32</u> |
| <u>25311-2</u> | <u>27,86</u> |
| <u>25391-4</u> | <u>9,32</u> |
| <u>25401-0</u> | <u>10,32</u> |
| <u>25411-9</u> | <u>27,86</u> |

auf Anfrage auch selbstklebend erhaeltlich/ self-adhesive version available on reqUest

Einfachklemmprofil, Aluminium eloxiert, gebohrt

single jam profile, aluminium anodized, drilled

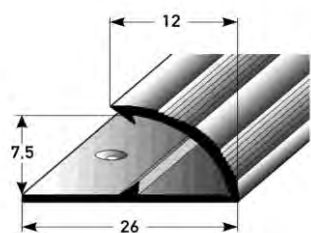

23

| | | | |
|-------------------|------------|----------------|--------------|
| silver coloured | <u>0,9</u> | <u>24090-7</u> | <u>4,86</u> |
| silver coloured | <u>1,0</u> | <u>24100-3</u> | <u>5,40</u> |
| silver coloured | <u>2,7</u> | <u>24110-2</u> | <u>14,50</u> |
| gold coloured | <u>0,9</u> | <u>24190-4</u> | <u>4,96</u> |
| gold coloured | <u>1,0</u> | <u>24200-0</u> | <u>5,50</u> |
| gold coloured | <u>2,7</u> | <u>24210-9</u> | <u>14,84</u> |
| bronze light col. | <u>0,9</u> | <u>24290-1</u> | <u>5,52</u> |
| bronze light col. | <u>1,0</u> | <u>24300-7</u> | <u>6,16</u> |
| bronze light col. | <u>2,7</u> | <u>24310-6</u> | <u>16,60</u> |
| bronze dark col. | <u>0,9</u> | <u>24390-8</u> | <u>5,52</u> |
| bronze dark col. | <u>1,0</u> | <u>24400-4</u> | <u>6,16</u> |
| bronze dark col. | <u>2,7</u> | <u>24410-3</u> | <u>16,60</u> |

| | |
|----------------|--------------|
| <u>24091-4</u> | <u>5,56</u> |
| <u>24101-0</u> | <u>6,18</u> |
| <u>24111-9</u> | <u>16,70</u> |
| <u>24191-1</u> | <u>5,68</u> |
| <u>24201-7</u> | <u>6,30</u> |
| <u>24211-6</u> | <u>17,02</u> |
| <u>24291-8</u> | <u>6,26</u> |
| <u>24301-4</u> | <u>6,94</u> |
| <u>24311-3</u> | <u>18,76</u> |
| <u>24391-5</u> | <u>6,26</u> |
| <u>24401-1</u> | <u>6,94</u> |
| <u>24411-0</u> | <u>18,76</u> |

auf Anfrage auch selbstklebend erhaeltlich/ self-adhesive version available on reqUest

Miniklemmprofil, Aluminium eloxiert, ungebohrt

mini jam profile, aluminium anodized, undrilled

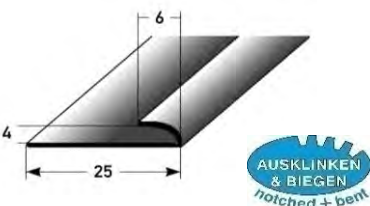

| | | | |
|------------------------------|------------|----------------|--------------|
| silberfarbig silver coloured | <u>1,0</u> | <u>36150-3</u> | <u>4,42</u> |
| silberfarbig silver coloured | <u>2,7</u> | <u>36110-7</u> | <u>12,00</u> |
| goldfarbiggold coloured | <u>1,0</u> | <u>36160-2</u> | <u>4,88</u> |
| goldfarbiggold coloured | <u>2,7</u> | <u>36120-6</u> | <u>13,18</u> |
| bronzef. Hell,bronze light | <u>1,0</u> | <u>36170-1</u> | <u>5,98</u> |
| bronzef. Hell,bronze light | <u>2,7</u> | <u>36130-5</u> | <u>16,22</u> |
| bronzef. Dunkel, bronze dark | <u>1,0</u> | <u>36180-0</u> | <u>5,98</u> |
| bronzef. Dunkel, bronze dark | <u>2,7</u> | <u>36140-4</u> | <u>16,22</u> |

| | |
|----------------|--------------|
| <u>36151-0</u> | <u>5,22</u> |
| <u>36111-4</u> | <u>14,20</u> |
| <u>36161-9</u> | <u>5,72</u> |
| <u>36121-3</u> | <u>15,36</u> |
| <u>36171-8</u> | <u>6,80</u> |
| <u>36131-2</u> | <u>18,38</u> |
| <u>36181-7</u> | <u>6,80</u> |
| <u>36141-1</u> | <u>18,38</u> |

auf Anfrage auch selbstklebend erhaeltlich/ self-adhesive version available on reqUest



| Befestigungsschenkel ausklinken attachment flanges notched | Art./ref. | €/m |
|---|----------------|-------------|
| | <u>22240-8</u> | <u>5,72</u> |

| Befestigungsschenkel ausklinken und biegen attachment flanges notched and bent | Art./ref. | €/m |
|---|------------------------|-----|
| | auf Anfrage on reqUest | |

5. EINSCHUB- & ANSTOßPROFILE / 5. INSERT PROFILES

Andere Eloxalfarben siehe
Abschnitt 6, Lieferzeit 14 Tage/
269 anodized colours see section 6,
delivery time 14 days

| Profi-Pack à 10 StUeck im Bund | | | |
|--------------------------------|-----------|-----------|-------------|
| professional packing à 10 pcs. | | | |
| Farbe/colour | L / l (m) | Art./ref. | €/Stk./pcs. |

| SB-Pack incl. Schr./ DUebel; VE 20 Stk. | |
|---|-------------|
| self-service-pack with screws/ dowels; à 20 pcs. | |
| Art./ref. | €/Stk./pcs. |

Einfasssschiene 2 mm, Aluminium eloxiert, gebohrt

insert profile 2 mm, aluminium
anodized, drilled

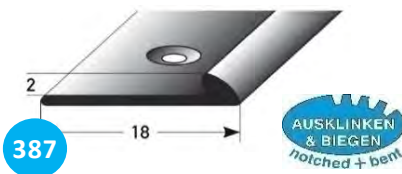

| | | | |
|--------------------------------|---------------------|-------------------------|-----------------------|
| silberfarbig silver | 2,7 | 46652-9 | 12,14 |
| goldfarbig gold | 2,7 | 46654-3 | 12,42 |
| bronzefarbig hell bronze light | 2,7 | 46656-7 | 13,80 |
| bronzef. dunkel bronze dark | 2,7 | 46658-1 | 13,80 |

| | |
|-------------------------|-----------------------|
| 46664-2 | 14,32 |
| 46666-6 | 14,58 |
| 46668-0 | 15,98 |
| 46670-3 | 15,98 |

Einfasssschiene 2,5 mm, Aluminium eloxiert, gebohrt

insert profile 2,5 mm, aluminium
anodized, drilled

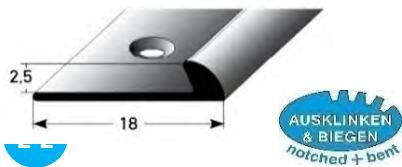

| | | | |
|--------------------------------|---------------------|-------------------------|-----------------------|
| silberfarbig silver | 2,7 | 66748-3 | 13,18 |
| goldfarbig gold | 2,7 | 66750-6 | 13,50 |
| bronzefarbig hell bronze light | 2,7 | 66752-0 | 14,88 |
| bronzef. dunkel bronze dark | 2,7 | 66754-4 | 14,88 |

| | |
|-------------------------|-----------------------|
| 66764-3 | 15,36 |
| 66766-7 | 15,68 |
| 66768-1 | 17,06 |
| 66770-4 | 17,06 |

Einfasssschiene 3 mm, Aluminium eloxiert, gebohrt

insert profile 3 mm, aluminium
anodized, drilled

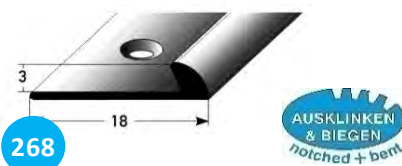

| | | | |
|--------------------------------|---------------------|-------------------------|-----------------------|
| silberfarbig silver | 2,7 | 46674-1 | 13,42 |
| goldfarbig gold | 2,7 | 46676-5 | 13,74 |
| bronzefarbig hell bronze light | 2,7 | 46678-9 | 15,12 |
| bronzef. dunkel bronze dark | 2,7 | 46680-2 | 15,12 |

| | |
|-------------------------|-----------------------|
| 46684-0 | 15,58 |
| 46686-4 | 15,90 |
| 46688-8 | 17,26 |
| 46690-1 | 17,26 |

Einfasssschiene 5 mm, Aluminium eloxiert, gebohrt

insert profile 5 mm, aluminium
anodized, drilled

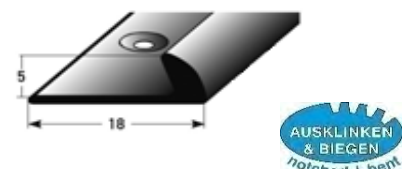

| | | | |
|--------------------------------|---------------------|-------------------------|-----------------------|
| silberfarbig silver | 2,7 | 46696-3 | 14,06 |
| goldfarbig gold | 2,7 | 46698-7 | 14,30 |
| bronzefarbig hell bronze light | 2,7 | 46700-7 | 15,68 |
| bronzef. dunkel bronze dark | 2,7 | 46702-1 | 15,68 |

| | |
|-------------------------|-----------------------|
| 46708-3 | 16,24 |
| 46710-6 | 16,50 |
| 46712-0 | 17,88 |
| 46714-4 | 17,88 |



| | | |
|---|-------------------------|----------------------|
| Befestigungsschenkel ausklinken attachment flanges notched | Art./ref. | €/m |
| | 22240-8 | 5,72 |

| | | |
|---|---------------------------|--|
| Befestigungsschenkel ausklinken und biegen attachment flanges notched and bent | auf Anfrage on reqUest | |
|---|---------------------------|--|

5. EINSCHUB- & ANSTOßPROFILE / 5. INSERT PROFILES

Andere Eloxalfarben siehe Abschnitt 6, Lieferzeit 14 Tage/
 27 anodized colours see section 6, delivery time 14 days

| Profi-Pack à 10 StUeck im Bund | | | |
|--------------------------------|-----------|-----------|-------------|
| professional packing à 10 pcs. | | | |
| Farbe/colour | L / l (m) | Art./ref. | €/Stk./pcs. |

| SB-Pack incl. Schr./DUebel; VE 20 Stk. | |
|---|-------------|
| self-service-pack with screws/dowels; à 20 pcs. | |
| Art./ref. | €/Stk./pcs. |

Anstossp. 3 mm, Aluminium elox., geb.

edge profile 3 mm, aluminium anodized, drilled

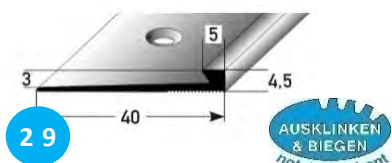

| | | | |
|--------------------------------|---------------------|-------------------------|-----------------------|
| silberfarbig silver | 2,7 | 47904-8 | 19,28 |
| goldfarbig, gold | 2,7 | 47908-6 | 19,98 |
| bronzefarbig hell bronze light | 2,7 | 47912-3 | 22,20 |
| bronzef. dunkel bronze dark | 2,7 | 47916-1 | 22,20 |

| | |
|-------------------------|-----------------------|
| 47906-2 | 21,70 |
| 47910-9 | 22,40 |
| 47914-7 | 24,64 |
| 47918-5 | 24,64 |

Anstosspr. 5/3, doppels., Alu.elox., geb.

edge profile 5/3, double, aluminium anodized, drilled

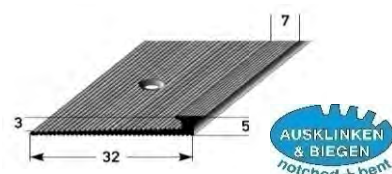

| | | | |
|--------------------------------|---------------------|-------------------------|-----------------------|
| silberfarbig silver | 2,7 | 35870-1 | 20,06 |
| goldfarbig, gold | 2,7 | 35880-0 | 21,36 |
| bronzefarbig hell bronze light | 2,7 | 35890-9 | 24,22 |
| bronzef. dunkel bronze dark | 2,7 | 35900-5 | 24,22 |

| | |
|-------------------------|-----------------------|
| 35871-8 | 22,26 |
| 35881-7 | 23,50 |
| 35891-6 | 26,38 |
| 35901-2 | 26,38 |



| Befestigungsschenkel ausklinken attachment flanges notched | |
|--|----------------------|
| Art./ref. | €/m |
| 22240-8 | 5,72 |

| | |
|------------------------|--|
| auf Anfrage on reqUest | |
|------------------------|--|

Anstossp. 3/3, doppels., Alu. Elox., geb.

edge profile 3/3, double, aluminium anodized, drilled

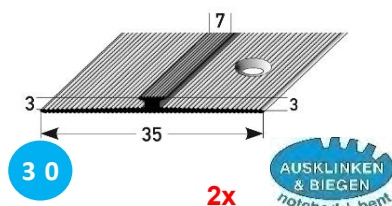

| | | | |
|--------------------------------|---------------------|-------------------------|-----------------------|
| silberfarbig silver | 2,7 | 35950-0 | 18,58 |
| goldfarbig, gold | 2,7 | 35960-9 | 19,86 |
| bronzefarbig hell bronze light | 2,7 | 35970-8 | 22,92 |
| bronzef. dunkel bronze dark | 2,7 | 35980-7 | 22,92 |

| | |
|-------------------------|-----------------------|
| 35951-7 | 20,74 |
| 35961-6 | 22,02 |
| 35971-5 | 25,12 |
| 35981-4 | 25,12 |

Anstossp.l 5/5, doppels., Alu. Elox. Geb.

edge profile 5/5, double, aluminium anodized, drilled

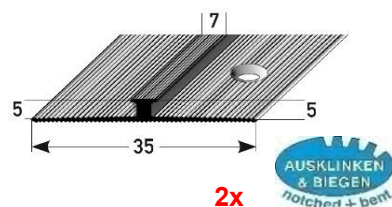

| | | | |
|--------------------------------|---------------------|-------------------------|-----------------------|
| silberfarbig silver | 2,7 | 36030-8 | 19,74 |
| goldfarbig, gold | 2,7 | 36040-7 | 20,96 |
| bronzefarbig hell bronze light | 2,7 | 36050-6 | 23,96 |
| bronzef. dunkel bronze dark | 2,7 | 36060-5 | 23,96 |

| | |
|-------------------------|-----------------------|
| 36031-5 | 21,90 |
| 36041-4 | 23,12 |
| 36051-3 | 26,16 |
| 36061-2 | 26,16 |



| 2 x Befestigungsschenkel ausklinken 2 x attachment flanges notched | |
|--|-----------------------|
| Art./ref. | €/m |
| 22260-6 | 11,42 |

| | |
|------------------------|--|
| auf Anfrage on reqUest | |
|------------------------|--|

5. EINSCHUB- & ANSTOßPROFILE/ 5. INSERT PROFILES

Andere Eloxalfarben siehe Abschnitt 6, Lieferzeit

282 €/m² other anodized colours see section 6, delivery time 14 days

| Profi-Pack à 10 StUeck im Bund | | | |
|--------------------------------|-----------|-----------|-------------|
| professional packing à 10 pcs. | | | |
| Farbe/colour | L / l (m) | Art./ref. | €/Stk./pcs. |

| SB-Pack incl. Schr./DUebel; VE 20 Stk. | |
|---|-------------|
| self-service-pack with screws/dowels: à 20 pcs. | |
| Art./ref. | €/Stk./pcs. |

Rampenanstoss 2 mm, Alu. Elox.t, geb.

ramp profile 2 mm, aluminium anodized, drilled

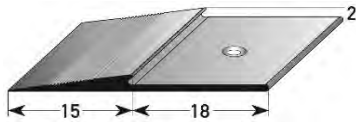

| | | | |
|-----------------------------------|-----|---------|-------|
| silberfarbig silver coloured | 1,0 | 35724-7 | 6,84 |
| silberfarbig silver coloured | 2,7 | 35726-1 | 18,48 |
| goldfarbiggold coloured | 1,0 | 35728-5 | 6,92 |
| goldfarbiggold coloured | 2,7 | 35730-8 | 18,74 |
| bronzef. Hell,bronze light | 1,0 | 35732-2 | 7,18 |
| bronzef. Hell,bronze light | 2,7 | 35734-6 | 19,36 |
| bronzef. Dunkel, bronze dark | 1,0 | 35736-0 | 7,18 |
| bronzef. Dunkel, bronze dark | 2,7 | 35738-4 | 19,36 |
| edelstahlfarb. Stainl. steel col. | 1,0 | 35710-0 | 7,18 |
| edelstahlfarb. Stainl. steel col. | 2,7 | 35712-4 | 19,36 |

| | |
|---------|-------|
| 35740-7 | 7,64 |
| 35742-1 | 20,72 |
| 35744-5 | 7,72 |
| 35746-9 | 20,92 |
| 35748-3 | 7,60 |
| 35750-6 | 20,54 |
| 35752-0 | 7,60 |
| 35754-4 | 20,54 |
| 35714-8 | 7,60 |
| 35716-2 | 20,54 |

283 Rampenanstoss 3 mm, Alu. Elox.t, geb.

ramp profile 3 mm, aluminium anodized, drilled

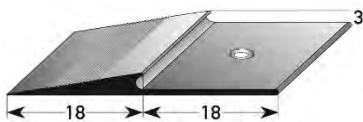

| | | | |
|-----------------------------------|-----|---------|-------|
| silberfarbig silver coloured | 1,0 | 35800-8 | 8,00 |
| silberfarbig silver coloured | 2,7 | 35802-2 | 21,50 |
| goldfarbiggold coloured | 1,0 | 35804-6 | 8,20 |
| goldfarbiggold coloured | 2,7 | 35806-0 | 22,16 |
| bronzef. Hell,bronze light | 1,0 | 35808-4 | 8,92 |
| bronzef. Hell,bronze light | 2,7 | 35810-7 | 24,06 |
| bronzef. Dunkel, bronze dark | 1,0 | 35812-1 | 8,92 |
| bronzef. Dunkel, bronze dark | 2,7 | 35814-5 | 24,06 |
| edelstahlfarb. Stainl. steel col. | 1,0 | 35720-9 | 8,92 |
| edelstahlfarb. Stainl. steel col. | 2,7 | 35722-3 | 24,06 |

| | |
|---------|-------|
| 35816-9 | 8,82 |
| 35818-3 | 23,78 |
| 35820-6 | 9,02 |
| 35822-0 | 24,40 |
| 35824-4 | 9,28 |
| 35826-8 | 25,08 |
| 35828-2 | 9,28 |
| 35830-5 | 25,08 |
| 35756-8 | 9,28 |
| 35758-2 | 25,08 |

284 Rampenanstoss 5 mm, Alu. Elox.t, geb.

ramp profile 5 mm, aluminium anodized, drilled

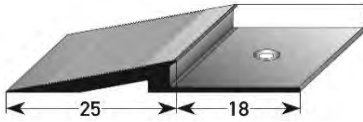

| | | | |
|-----------------------------------|-----|---------|-------|
| silberfarbig silver coloured | 1,0 | 35832-9 | 9,60 |
| silberfarbig silver coloured | 2,7 | 35834-3 | 25,94 |
| goldfarbiggold coloured | 1,0 | 35836-7 | 9,82 |
| goldfarbiggold coloured | 2,7 | 35838-1 | 26,52 |
| bronzef. Hell,bronze light | 1,0 | 35840-4 | 11,54 |
| bronzef. Hell,bronze light | 2,7 | 35842-8 | 31,18 |
| bronzef. Dunkel, bronze dark | 1,0 | 35844-2 | 11,54 |
| bronzef. Dunkel, bronze dark | 2,7 | 35846-6 | 31,18 |
| edelstahlfarb. Stainl. steel col. | 1,0 | 35762-9 | 11,54 |
| edelstahlfarb. Stainl. steel col. | 2,7 | 35764-3 | 31,18 |

| | |
|---------|-------|
| 35848-0 | 9,92 |
| 35850-3 | 26,86 |
| 35852-7 | 10,12 |
| 35854-1 | 27,42 |
| 35856-5 | 11,76 |
| 35858-9 | 31,86 |
| 35860-2 | 11,76 |
| 35862-6 | 31,86 |
| 35766-7 | 11,76 |
| 35768-1 | 31,86 |

480 Rampenanstoss 8 mm, Alu. Elox.t, geb.

ramp profile 8 mm, aluminium anodized, drilled

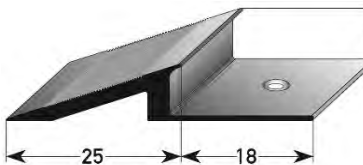

| | | | |
|-----------------------------------|-----|---------|-------|
| silberfarbig silver coloured | 1,0 | 70916-9 | 11,54 |
| silberfarbig silver coloured | 2,7 | 70918-3 | 31,12 |
| goldfarbiggold coloured | 1,0 | 70920-6 | 11,80 |
| goldfarbiggold coloured | 2,7 | 70922-0 | 31,82 |
| bronzef. Hell,bronze light | 1,0 | 70924-4 | 13,84 |
| bronzef. Hell,bronze light | 2,7 | 70926-8 | 37,40 |
| bronzef. Dunkel, bronze dark | 1,0 | 70928-2 | 13,84 |
| bronzef. Dunkel, bronze dark | 2,7 | 70930-5 | 37,40 |
| edelstahlfarb. Stainl. steel col. | 1,0 | 70932-9 | 13,84 |
| edelstahlfarb. Stainl. steel col. | 2,7 | 70934-3 | 37,40 |

| | |
|---------|-------|
| 70936-7 | 11,76 |
| 70938-1 | 31,80 |
| 70940-4 | 12,00 |
| 70942-8 | 32,48 |
| 70944-2 | 13,96 |
| 70946-6 | 37,80 |
| 70948-0 | 13,96 |
| 70950-3 | 37,80 |
| 70952-7 | 13,96 |
| 70954-1 | 37,80 |



| | |
|---|--|
| Befestigungsschenkel ausklinken attachment flanges notched | |
| Befestigungsschenkel ausklinken und biegen attachment flanges notched and bent | |

| Art./ref. | €/m |
|---------------------------|------|
| 22240-8 | 5,72 |
| auf Anfrage on reqUest | |

5. EINSCHUB- & ANSTOßPROFILE/ 5. INSERT PROFILES

Andere Eloxalfarben siehe Abschnitt 6, Lieferzeit 14 Tage/
 258 anodized colours see section 6, delivery time 14 days

| Profi-Pack à 10 StUeck im Bund | | | |
|--------------------------------|-----------|-----------|-------------|
| professional packing à 10 pcs. | | | |
| Farbe/colour | L / l (m) | Art./ref. | €/Stk./pcs. |

| SB-Pack incl. Schr./DUebel; VE 20 Stk. | |
|---|-------------|
| self-service-pack with screws/dowels; à 20 pcs. | |
| Art./ref. | €/Stk./pcs. |

Einschubp.3 mm, Alu.elox. Geb.

insert profile 3 mm, aluminium anodized, drilled

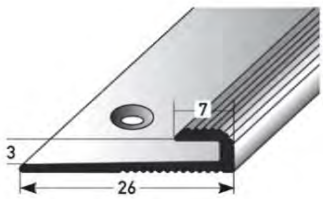

1 8

| | | | |
|-------------------|---------------------|-------------------------|-----------------------|
| silver coloured | 0,9 | 46718-2 | 5,30 |
| silver coloured | 1,0 | 46720-5 | 5,88 |
| silver coloured | 2,7 | 46722-9 | 15,88 |
| gold coloured | 0,9 | 46732-8 | 5,48 |
| gold coloured | 1,0 | 46734-2 | 6,10 |
| gold coloured | 2,7 | 46736-6 | 16,40 |
| bronze light col. | 0,9 | 46746-5 | 6,28 |
| bronze light col. | 1,0 | 46748-9 | 6,98 |
| bronze light col. | 2,7 | 46750-2 | 18,82 |
| bronze dark col. | 0,9 | 46760-1 | 6,28 |
| bronze dark col. | 1,0 | 46762-5 | 6,98 |
| bronze dark col. | 2,7 | 46764-9 | 18,82 |

| | |
|-------------------------|-----------------------|
| 46724-3 | 6,12 |
| 46726-7 | 6,68 |
| 46728-1 | 18,32 |
| 46738-0 | 6,28 |
| 46740-3 | 6,88 |
| 46742-7 | 18,82 |
| 46752-6 | 7,08 |
| 46754-0 | 7,76 |
| 46756-4 | 21,24 |
| 46766-3 | 7,08 |
| 46768-7 | 7,76 |
| 46770-0 | 21,24 |

Einschubp.5mm, Alu.elox. Geb.

insert profile 5 mm, aluminium anodized, drilled

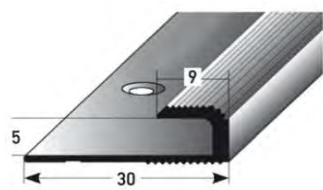

2 4

| | | | |
|-------------------|---------------------|-------------------------|-----------------------|
| silver coloured | 0,9 | 26090-5 | 5,86 |
| silver coloured | 1,0 | 26100-1 | 6,52 |
| silver coloured | 2,7 | 26130-8 | 17,60 |
| gold coloured | 0,9 | 26190-2 | 6,00 |
| gold coloured | 1,0 | 26200-8 | 6,70 |
| gold coloured | 2,7 | 26230-5 | 18,04 |
| bronze light col. | 0,9 | 26290-9 | 7,16 |
| bronze light col. | 1,0 | 26300-5 | 7,98 |
| bronze light col. | 2,7 | 26330-2 | 21,46 |
| bronze dark col. | 0,9 | 26390-6 | 7,16 |
| bronze dark col. | 1,0 | 26400-2 | 7,98 |
| bronze dark col. | 2,7 | 26430-9 | 21,46 |

| | |
|-------------------------|-----------------------|
| 26091-2 | 6,58 |
| 26101-8 | 7,32 |
| 26131-5 | 19,76 |
| 26191-9 | 6,76 |
| 26201-5 | 7,52 |
| 26231-2 | 20,26 |
| 26291-6 | 7,90 |
| 26301-2 | 8,76 |
| 26331-9 | 23,62 |
| 26391-3 | 7,90 |
| 26401-9 | 8,76 |
| 26431-6 | 23,62 |

Einschubp.6 mm, Alu.elox. Geb.

insert profile 6 mm, aluminium anodized, drilled

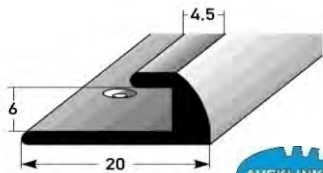

| | | | |
|--------------------------------|---------------------|-------------------------|-----------------------|
| silberfarbig silver | 2,7 | 47886-7 | 15,82 |
| goldfarbig, gold | 2,7 | 47890-4 | 16,08 |
| bronzefarbig hell bronze light | 2,7 | 47894-2 | 18,06 |
| bronzef. dunkel bronze dark | 2,7 | 47898-0 | 18,06 |

| | |
|-------------------------|-----------------------|
| 47888-1 | 18,26 |
| 47892-8 | 18,48 |
| 47896-6 | 20,50 |
| 47900-0 | 20,50 |

auf Anfrage auch selbstklebend erhaeltlich/ self-adhesive version available on reqUes



| |
|---|
| Befestigungsschenkel ausklinken attachment flanges notched |
| Befestigungsschenkel ausklinken und biegen attachment flanges notched and bent |

| | |
|---------------------------|----------------------|
| Art./ref. | €/m |
| 22240-8 | 5,72 |
| auf Anfrage on reqUest | |

5. EINSCHUB- & ANSTOßPROFILE / 5. INSERT PROFILES

Andere Eloxalfarben siehe Abschnitt 6, Lieferzeit 14 Tage/
other anodized colours see section 6, delivery time 14 days

| Profi-Pack à 10 StUeck im Bund | | | |
|------------------------------------|-----------|-----------|-------------|
| 446 professional packing à 10 pcs. | | | |
| Farbe/colour | L / l (m) | Art./ref. | €/Stk./pcs. |

| SB-Pack incl. Schr./ DUEbel; VE 20 Stk. | |
|--|-------------|
| self-service-pack with screws/ dowels; à 20 pcs. | |
| Art./ref. | €/Stk./pcs. |

Einschubpr. Laminat 7 mm, Alu. Elox., geb.

insert profile for laminate 7 mm, aluminium anodized, drilled

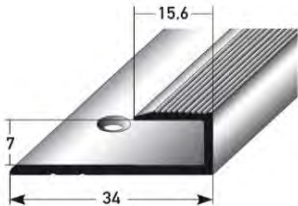

| | | | |
|------------------------------|-----|---------|-------|
| silberfarbig silver coloured | 1,0 | 48120-1 | 5,38 |
| silberfarbig silver coloured | 2,7 | 48122-5 | 14,50 |
| goldfarbiggold coloured | 1,0 | 48128-7 | 5,52 |
| goldfarbiggold coloured | 2,7 | 48130-0 | 14,90 |
| bronzef. Hell,bronze light | 1,0 | 48144-7 | 6,00 |
| bronzef. Hell,bronze light | 2,7 | 48146-1 | 16,20 |
| bronzef. Dunkel, bronze dark | 1,0 | 48152-2 | 6,00 |
| bronzef. Dunkel, bronze dark | 2,7 | 48154-6 | 16,20 |

| | |
|---------|-------|
| 48124-9 | 6,18 |
| 48126-3 | 16,96 |
| 48132-4 | 6,34 |
| 48134-8 | 17,36 |
| 48148-5 | 6,82 |
| 48150-8 | 18,66 |
| 48156-0 | 6,82 |
| 48158-4 | 18,66 |

Einschubpr. Laminat 8mm, Alu. Elox., geb.

insert profile for laminate 8 mm, aluminium anodized, drilled

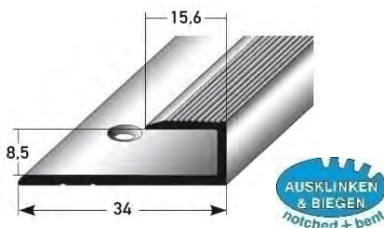

| | | | |
|------------------------------|-----|---------|-------|
| silberfarbig silver coloured | 1,0 | 29160-2 | 5,76 |
| silberfarbig silver coloured | 2,7 | 29165-7 | 15,58 |
| goldfarbiggold coloured | 1,0 | 29170-1 | 5,92 |
| goldfarbiggold coloured | 2,7 | 29175-6 | 16,08 |
| bronzef. Hell,bronze light | 1,0 | 29180-0 | 6,44 |
| bronzef. Hell,bronze light | 2,7 | 29185-5 | 17,40 |
| bronzef. Dunkel, bronze dark | 1,0 | 29190-9 | 6,44 |
| bronzef. Dunkel, bronze dark | 2,7 | 29195-4 | 17,40 |
| gold hell , gold light | 1,0 | 62135-5 | 5,92 |
| gold hell , gold light | 2,7 | 62140-9 | 16,08 |

| | |
|---------|-------|
| 29166-4 | 6,58 |
| 29167-1 | 17,78 |
| 29176-3 | 6,76 |
| 29177-0 | 18,28 |
| 29186-2 | 7,26 |
| 29187-9 | 19,58 |
| 29196-1 | 7,26 |
| 29197-8 | 19,58 |
| 62145-4 | 6,76 |
| 62155-3 | 18,28 |

109

Holzdekorfolie/ wood decor

| | | | |
|----------------------------|-----|---------|-------|
| Buche, beech | 1,0 | 40580-1 | 8,60 |
| Buche, beech | 2,7 | 40600-6 | 23,18 |
| Eiche, oak | 1,0 | 40610-5 | 8,60 |
| Eiche, oak | 2,7 | 40630-3 | 23,18 |
| Ahorn, maple | 1,0 | 40640-2 | 8,60 |
| Ahorn, maple | 2,7 | 40660-0 | 23,18 |
| Kirschbaum, cherry wood | 1,0 | 43154-1 | 8,60 |
| Kirschbaum, cherry wood | 2,7 | 43158-9 | 23,18 |
| Eiche rustikal ,rustic oak | 1,0 | 43162-6 | 8,60 |
| Eiche rustikal ,rustic oak | 2,7 | 43166-4 | 23,18 |

| | |
|---------|-------|
| 40581-8 | 9,44 |
| 40601-3 | 25,50 |
| 40611-2 | 9,44 |
| 40631-0 | 25,50 |
| 40641-9 | 9,44 |
| 40661-7 | 25,50 |
| 43156-5 | 9,44 |
| 43160-2 | 25,50 |
| 43164-0 | 9,44 |
| 43168-8 | 25,50 |

Einschubpr. Laminat 10mm, Alu. Elox., geb.

insert profile for wooden floor, 10 mm, aluminium anodized, drilled



| | | | |
|------------------------------|-----|---------|-------|
| silberfarbig silver coloured | 1,0 | 29500-6 | 7,14 |
| silberfarbig silver coloured | 2,7 | 29505-1 | 19,18 |
| goldfarbiggold coloured | 1,0 | 29510-5 | 7,84 |
| goldfarbiggold coloured | 2,7 | 29515-0 | 21,16 |
| bronzef. Hell,bronze light | 1,0 | 29520-4 | 9,06 |
| bronzef. Hell,bronze light | 2,7 | 29525-9 | 24,56 |
| bronzef. Dunkel, bronze dark | 1,0 | 29530-3 | 9,06 |
| bronzef. Dunkel, bronze dark | 2,7 | 29535-8 | 24,56 |

| | |
|---------|-------|
| 29506-8 | 7,96 |
| 29507-5 | 21,38 |
| 29516-7 | 8,66 |
| 29517-4 | 23,38 |
| 29526-6 | 9,90 |
| 29527-3 | 26,70 |
| 29536-5 | 9,90 |
| 29537-2 | 26,70 |



| | | |
|---|---------------------------|------|
| Befestigungsschenkel ausklinken attachment flanges notched | Art./ref. | €/m |
| Befestigungsschenkel ausklinken und biegen attachment flanges notched and bent | 22240-8 | 5,72 |
| | auf Anfrage on reqUest | |

5. EINSCHUB- & ANSTOßPROFILE / 5. INSERT PROFILES

Andere Eloxalfarben siehe Abschnitt 6, Lieferzeit 14 Tage/
 anodized colours see section 6, delivery time 14 days

110

| Profi-Pack à 10 StUeck im Bund | | | |
|--------------------------------|-----------|-----------|-------------|
| professional packing à 10 pcs. | | | |
| Farbe/colour | L / l (m) | Art./ref. | €/Stk./pcs. |

| SB-Pack incl. Schr./DUebel; VE 20 Stk. | |
|---|-------------|
| self-service-pack with screws/dowels; à 20 pcs. | |
| Art./ref. | €/Stk./pcs. |

Einschubp,Parkett 13 mm, Alu. Elox. Geb.

insert profile for wooden floor, 13 mm, aluminium anodized, drilled

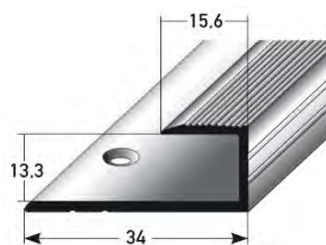

111

AUSKLINKEN & BIEGEN
notched + bent

| | | | |
|------------------------------|---------------------|-------------------------|-----------------------|
| silberfarbig silver coloured | 1.0 | 29540-2 | 7.76 |
| silberfarbig silver coloured | 2.7 | 29545-7 | 21.00 |
| goldfarbiggold coloured | 1.0 | 29550-1 | 8.10 |
| goldfarbiggold coloured | 2.7 | 29555-6 | 21.88 |
| bronzef. Hell,bronze light | 1.0 | 29560-0 | 9.36 |
| bronzef. Hell,bronze light | 2.7 | 29565-5 | 25.20 |
| bronzef. Dunkel, bronze dark | 1.0 | 29570-9 | 9.36 |
| bronzef. Dunkel, bronze dark | 2.7 | 29575-4 | 25.20 |

| | |
|-------------------------|-----------------------|
| 29546-4 | 8.60 |
| 29547-1 | 23.18 |
| 29556-3 | 8.92 |
| 29557-0 | 24.06 |
| 29566-2 | 10.16 |
| 29567-9 | 27.40 |
| 29576-1 | 10.16 |
| 29577-8 | 27.40 |

Einschubp,Parkett 15mm, Alu. Elox. Geb.

insert profile for wooden floor, 15 mm, aluminium anodized, drilled

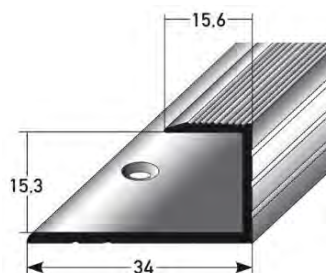

112

AUSKLINKEN & BIEGEN
notched + bent

Holzdekorfolie/ wood decor

| | | | |
|------------------------------|---------------------|-------------------------|-----------------------|
| silberfarbig silver coloured | 1.0 | 29580-8 | 8.28 |
| silberfarbig silver coloured | 2.7 | 29585-3 | 22.42 |
| goldfarbiggold coloured | 1.0 | 29590-7 | 8.70 |
| goldfarbiggold coloured | 2.7 | 29595-2 | 23.50 |
| bronzef. Hell,bronze light | 1.0 | 29600-3 | 9.84 |
| bronzef. Hell,bronze light | 2.7 | 29605-8 | 26.58 |
| bronzef. Dunkel, bronze dark | 1.0 | 29610-2 | 9.84 |
| bronzef. Dunkel, bronze dark | 2.7 | 29615-7 | 26.58 |
| gold hell ,old light | 1.0 | 62100-3 | 8.70 |
| gold hell ,old light | 2.7 | 62105-8 | 23.50 |

| | |
|-------------------------|-----------------------|
| 29586-0 | 9.08 |
| 29587-7 | 24.58 |
| 29596-9 | 9.52 |
| 29597-6 | 25.66 |
| 29606-5 | 10.66 |
| 29607-2 | 28.76 |
| 29616-4 | 10.66 |
| 29617-1 | 28.76 |
| 62110-2 | 9.52 |
| 62120-1 | 25.66 |

| | | | |
|----------------------------|---------------------|-------------------------|-----------------------|
| Buche, beech | 1.0 | 40670-9 | 9.78 |
| Buche, beech | 2.7 | 40690-7 | 26.38 |
| Eiche, oak | 1.0 | 40700-3 | 9.78 |
| Eiche, oak | 2.7 | 40720-1 | 26.38 |
| Ahorn,maple | 1.0 | 40730-0 | 9.78 |
| Ahorn,maple | 2.7 | 40750-8 | 26.38 |
| Kirschbaum,cherry wood | 1.0 | 43172-5 | 9.78 |
| Kirschbaum,cherry wood | 2.7 | 43176-3 | 26.38 |
| Eiche rustikal ,rustic oak | 1.0 | 43180-0 | 9.78 |
| Eiche rustikal ,rustic oak | 2.7 | 43184-8 | 26.38 |

| | |
|-------------------------|-----------------------|
| 40671-6 | 10.62 |
| 40691-4 | 28.70 |
| 40701-0 | 10.62 |
| 40721-8 | 28.70 |
| 40731-7 | 10.62 |
| 40751-5 | 28.70 |
| 43174-9 | 10.62 |
| 43178-7 | 28.70 |
| 43182-4 | 10.62 |
| 43186-2 | 28.70 |

AUSKLINKEN & BIEGEN
notched + bent

| | | |
|---|---------------------------|----------------------|
| Befestigungsschenkel ausklinken attachment flanges notched | Art./ref. | €/m |
| | 22240-8 | 5.72 |
| Befestigungsschenkel ausklinken und biegen attachment flanges notched and bent | auf Anfrage on reqUest | |

5. EINSCHUB- & ANSTOßPROFILE / 5. INSERT PROFILES

Andere Eloxalfarben siehe Abschnitt 6, Lieferzeit 14 Tage/
other anodized colours see section 6,
delivery time 14 days

| Profi-Pack à 10 StUeck im Bund | | | |
|--------------------------------|-----------|-----------|-------------|
| professional packing à 10 pcs. | | | |
| Farbe/colour | L / l (m) | Art./ref. | €/Stk./pcs. |

| SB-Pack incl. Schr./ DUebel; VE 20 Stk. | |
|---|-------------|
| self-service-pack with screws/ dowels; à 20 pcs. | |
| Art./ref. | €/Stk./pcs. |

2 1 Einschubp. 3 mm mit Nase, Alu. Elox., geb.

nosed insert profile 3 mm,
aluminium anodized,
drilled



| | | | |
|-------------------|-----|---------|-------|
| silver coloured | 0,9 | 32070-8 | 5,54 |
| silver coloured | 1,0 | 32075-3 | 6,18 |
| silver coloured | 2,7 | 32080-7 | 16,64 |
| gold coloured | 0,9 | 32085-2 | 5,86 |
| gold coloured | 1,0 | 32090-6 | 6,52 |
| gold coloured | 2,7 | 32095-1 | 17,58 |
| bronze light col. | 0,9 | 32100-2 | 6,76 |
| bronze light col. | 1,0 | 32105-7 | 7,48 |
| bronze light col. | 2,7 | 32110-1 | 20,20 |
| bronze dark col. | 0,9 | 32115-6 | 6,76 |
| bronze dark col. | 1,0 | 32120-0 | 7,48 |
| bronze dark col. | 2,7 | 32125-5 | 20,20 |

| | |
|---------|-------|
| 32071-5 | 6,28 |
| 32076-0 | 6,94 |
| 32081-4 | 18,80 |
| 32086-9 | 6,58 |
| 32091-3 | 7,32 |
| 32096-8 | 19,74 |
| 32101-9 | 7,48 |
| 32106-4 | 8,28 |
| 32111-8 | 22,42 |
| 32116-3 | 7,48 |
| 32121-7 | 8,28 |
| 32126-2 | 22,42 |

Einschubp. 3 mm mit Nase 24mm, Alu. Elox., geb.

insert profile 3 mm with 24 mm
nose, alu anodized, drilled



| | | | |
|------------------------------|-----|---------|-------|
| silberfarbig silver coloured | 1,0 | 70862-9 | 9,50 |
| silberfarbig silver coloured | 2,7 | 70864-3 | 25,66 |
| goldfarbiggold coloured | 1,0 | 70870-4 | 9,72 |
| goldfarbiggold coloured | 2,7 | 70872-8 | 26,22 |
| bronzef. Hell, bronze light | 1,0 | 70878-0 | 10,98 |
| bronzef. Hell, bronze light | 2,7 | 70880-3 | 29,62 |
| bronzef. Dunkel, bronze dark | 1,0 | 70886-5 | 10,98 |
| bronzef. Dunkel, bronze dark | 2,7 | 70888-9 | 29,62 |

| | |
|---------|-------|
| 70866-7 | 10,26 |
| 70868-1 | 27,82 |
| 70874-2 | 10,52 |
| 70876-6 | 28,38 |
| 70882-7 | 11,76 |
| 70884-1 | 31,84 |
| 70890-2 | 11,76 |
| 70892-6 | 31,84 |

1 7 Einschubp. 5 mm mit Nase lu. Elox., geb.

nosed insert profile 5 mm,
aluminium anodized, drilled

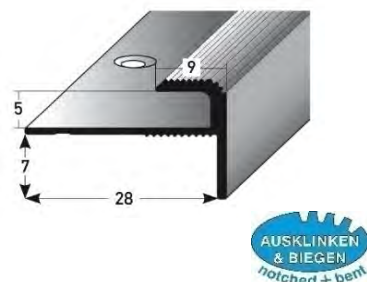

| | | | |
|-------------------|-----|---------|-------|
| silver coloured | 0,9 | 27090-4 | 6,66 |
| silver coloured | 1,0 | 27100-0 | 7,36 |
| silver coloured | 2,7 | 27130-7 | 19,96 |
| gold coloured | 0,9 | 27190-1 | 6,80 |
| gold coloured | 1,0 | 27200-7 | 7,56 |
| gold coloured | 2,7 | 27230-4 | 20,38 |
| bronze light col. | 0,9 | 27290-8 | 8,02 |
| bronze light col. | 1,0 | 27300-4 | 8,90 |
| bronze light col. | 2,7 | 27330-1 | 23,98 |
| bronze dark col. | 0,9 | 27390-5 | 8,02 |
| bronze dark col. | 1,0 | 27400-1 | 8,90 |
| bronze dark col. | 2,7 | 27430-8 | 23,98 |

| | |
|---------|-------|
| 27091-1 | 7,36 |
| 27101-7 | 8,18 |
| 27131-4 | 22,12 |
| 27191-8 | 7,54 |
| 27201-4 | 8,36 |
| 27231-1 | 22,58 |
| 27291-5 | 8,72 |
| 27301-1 | 9,70 |
| 27331-8 | 26,18 |
| 27391-2 | 8,72 |
| 27401-8 | 9,70 |
| 27431-5 | 26,18 |

9 3 Einschubp. 5 mm mit Nase 24 mm lu. Elox., geb.

insert profile 5 mm
with 24 mm nose,
aluminium anodized, drilled

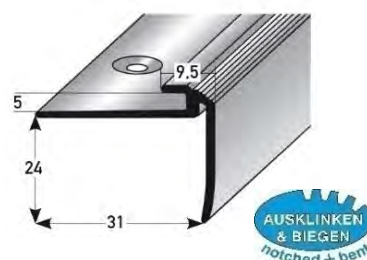

| | | | |
|-------------------|-----|---------|-------|
| silver coloured | 0,9 | 32005-0 | 9,60 |
| silver coloured | 1,0 | 32010-4 | 10,68 |
| silver coloured | 2,7 | 32015-9 | 28,84 |
| gold coloured | 0,9 | 32020-3 | 9,68 |
| gold coloured | 1,0 | 32025-8 | 10,74 |
| gold coloured | 2,7 | 32030-2 | 29,04 |
| bronze light col. | 0,9 | 32035-7 | 11,14 |
| bronze light col. | 1,0 | 32040-1 | 12,38 |
| bronze light col. | 2,7 | 32045-6 | 33,34 |
| bronze dark col. | 0,9 | 32050-0 | 11,14 |
| bronze dark col. | 1,0 | 32055-5 | 12,38 |
| bronze dark col. | 2,7 | 32060-9 | 33,34 |

| | |
|---------|-------|
| 32006-7 | 10,34 |
| 32011-1 | 11,48 |
| 32016-6 | 31,02 |
| 32021-0 | 10,40 |
| 32026-5 | 11,54 |
| 32031-9 | 31,20 |
| 32036-4 | 11,84 |
| 32041-8 | 13,16 |
| 32046-3 | 35,52 |
| 32051-7 | 11,84 |
| 32056-2 | 13,16 |
| 32061-6 | 35,52 |



| |
|---|
| Befestigungsschenkel ausklinken attachment flanges notched |
|---|

| |
|---|
| Befestigungsschenkel ausklinken und biegen attachment flanges notched and bent |
|---|

| Art./ref. | €/m |
|-----------|------|
| 22240-8 | 5,72 |

| |
|---------------------------|
| auf Anfrage on request |
|---------------------------|

5. EINSCHUB- & ANSTOßPROFILE / 5. INSERT PROFILES

Andere Eloxalfarben siehe Abschnitt 6, Lieferzeit 14 Tage/

105 anodized colours see section 6, delivery time 14 days

| Profi-Pack à 10 StUeck im Bund | | | |
|--------------------------------|-----------|-----------|-------------|
| professional packing à 10 pcs. | | | |
| Farbe/colour | L / l (m) | Art./ref. | €/Stk./pcs. |

| SB-Pack incl. Schr./DUebel; VE 20 Stk. | |
|---|-------------|
| self-service-pack with screws/dowels; à 20 pcs. | |
| Art./ref. | €/Stk./pcs. |

Einschubp. 8,5 mm mit Nase Laminat, Alu. Elox., geb.

nosed insert profile for laminate 8,5 mm, aluminium anodized, drilled

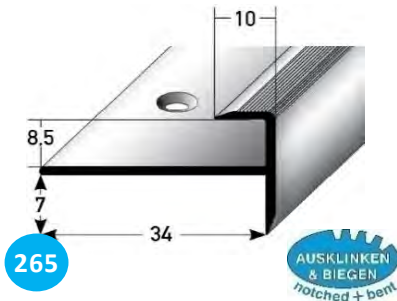

| | | | |
|------------------------------|-----|---------|-------|
| silberfarbig silver coloured | 1.0 | 32140-8 | 8.22 |
| silberfarbig silver coloured | 2.7 | 32145-3 | 22.20 |
| goldfarbiggold coloured | 1.0 | 32155-2 | 8.50 |
| goldfarbiggold coloured | 2.7 | 32160-6 | 22.86 |
| bronzef. Hell,bronze light | 1.0 | 32170-5 | 8.96 |
| bronzef. Hell,bronze light | 2.7 | 32175-0 | 24.18 |
| bronzef. Dunkel, bronze dark | 1.0 | 32185-9 | 8.96 |
| bronzef. Dunkel, bronze dark | 2.7 | 32190-3 | 24.18 |
| gold hell, gold light | 1.0 | 62175-1 | 8.50 |
| gold hell, gold light | 2.7 | 62180-5 | 22.86 |

| | |
|---------|-------|
| 32141-5 | 9.02 |
| 32146-0 | 24.64 |
| 32156-9 | 9.28 |
| 32161-3 | 25.28 |
| 32171-2 | 9.76 |
| 32176-7 | 26.60 |
| 32186-6 | 9.76 |
| 32191-0 | 26.60 |
| 62190-4 | 9.28 |
| 62195-9 | 25.28 |

Einschubp. 8,5 mm mit Nase 44mm Laminat, Alu. Elox., geb.

insert profile with 44 mm nose for laminate 8,5 mm, aluminium anodized, drilled



| | | | |
|------------------------------|-----|---------|-------|
| silberfarbig silver coloured | 1.0 | 46234-7 | 13.32 |
| silberfarbig silver coloured | 2.7 | 46236-1 | 35.94 |
| goldfarbiggold coloured | 1.0 | 46248-4 | 13.88 |
| goldfarbiggold coloured | 2.7 | 46250-7 | 37.54 |
| bronzef. Hell,bronze light | 1.0 | 46262-0 | 15.28 |
| bronzef. Hell,bronze light | 2.7 | 46264-4 | 41.24 |
| bronzef. Dunkel, bronze dark | 1.0 | 46276-7 | 15.28 |
| bronzef. Dunkel, bronze dark | 2.7 | 46278-1 | 41.24 |
| gold hell, gold light | 1.0 | 46438-9 | 13.88 |
| gold hell, gold light | 2.7 | 46440-2 | 37.54 |

| | |
|---------|-------|
| 46240-8 | 14.10 |
| 46242-2 | 38.36 |
| 46254-5 | 14.68 |
| 46256-9 | 39.94 |
| 46268-2 | 16.08 |
| 46270-5 | 43.66 |
| 46282-8 | 16.08 |
| 46284-2 | 43.66 |
| 46442-6 | 14.68 |
| 46444-0 | 39.94 |

Einschubp. 10mm mit Nase 44mm Parkett, Alu. Elox., geb.

insert profile with 44 mm nose for wooden floor 10 mm, aluminium anodized, drilled

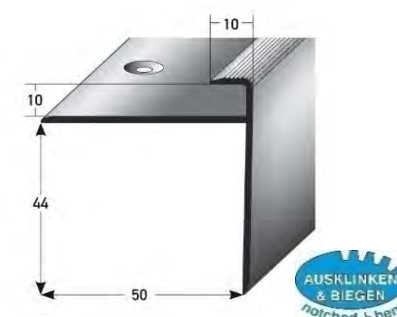

| | | | |
|------------------------------|-----|---------|-------|
| silberfarbig silver coloured | 1.0 | 67100-8 | 14.02 |
| silberfarbig silver coloured | 2.7 | 67102-2 | 37.84 |
| goldfarbiggold coloured | 1.0 | 67104-6 | 14.58 |
| goldfarbiggold coloured | 2.7 | 67106-0 | 39.40 |
| bronzef. Hell,bronze light | 1.0 | 67112-1 | 15.98 |
| bronzef. Hell,bronze light | 2.7 | 67114-5 | 43.14 |
| bronzef. Dunkel, bronze dark | 1.0 | 67116-9 | 15.98 |
| bronzef. Dunkel, bronze dark | 2.7 | 67118-3 | 43.14 |
| gold hell, gold light | 1.0 | 67108-4 | 14.58 |
| gold hell, gold light | 2.7 | 67110-7 | 39.40 |

| | |
|---------|-------|
| 67124-4 | 14.82 |
| 67126-8 | 40.24 |
| 67128-2 | 15.38 |
| 67130-5 | 41.78 |
| 67136-7 | 16.76 |
| 67138-1 | 45.50 |
| 67140-4 | 16.76 |
| 67142-8 | 45.50 |
| 67132-9 | 15.38 |
| 67134-3 | 41.78 |

502 Einschubprofil 5 mm mit 44 mm Nase. Aluminium eloxiert, gebohrt

insert profile 5 mm with 44 mm nose, alu anodized, drilled

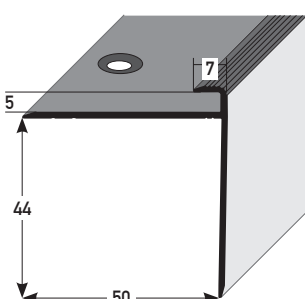

| | | | |
|---------------------------------|-----|---------|-------|
| silberfarbig silver | 1.0 | 71498-9 | 14.02 |
| silberfarbig silver | 2.7 | 71500-9 | 37.84 |
| goldfarbig gold | 1.0 | 71502-3 | 14.58 |
| goldfarbig gold | 2.7 | 71504-7 | 39.40 |
| bronzefarbig hell bronze light | 1.0 | 71506-1 | 15.98 |
| bronzefarbig hell bronze light | 2.7 | 71508-5 | 43.14 |
| bronzefarbig dunkel bronze dark | 1.0 | 71510-8 | 15.98 |
| bronzefarbig dunkel bronze dark | 2.7 | 71512-2 | 43.14 |

| | |
|---------|-------|
| 71514-6 | 14.82 |
| 71516-0 | 40.24 |
| 71518-4 | 15.38 |
| 71520-7 | 41.78 |
| 71522-1 | 16.76 |
| 71524-5 | 45.50 |
| 71526-9 | 16.76 |
| 71528-3 | 45.50 |

5. EINSCHUB- & ANSTOßPROFILE/ 5. INSERT PROFILES

Andere Eloxalfarben siehe Abschnitt 6, Lieferzeit 14 Tage/
other anodized colours see section 6,
delivery time 14 days

| Profi-Pack à 10 StUeck im Bund | | | |
|--------------------------------|-----------|-----------|-------------|
| professional packing à 10 pcs. | | | |
| Farbe/colour | L / l (m) | Art./ref. | €/Stk./pcs. |

| SB-Pack incl. Schr./ DUebel; VE 20 Stk. | |
|---|-------------|
| self-service-pack with screws/ dowels; à 20 pcs. | |
| Art./ref. | €/Stk./pcs. |

Einschubp. 10mm mit Nase 7mm Parkett, Alu. Elox., geb.

262

nosed insert profile for
wooden floor 10 mm,
aluminium anodized, drilled

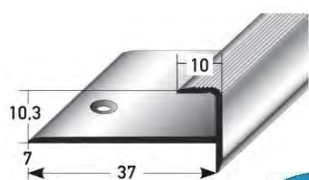

| | | | |
|------------------------------|-----|---------|-------|
| silberfarbig silver coloured | 1.0 | 46122-7 | 8.72 |
| silberfarbig silver coloured | 2.7 | 46124-1 | 23.60 |
| goldfarbiggold coloured | 1.0 | 46136-4 | 9.10 |
| goldfarbiggold coloured | 2.7 | 46138-8 | 24.64 |
| bronzef. Hell, bronze light | 1.0 | 46150-0 | 9.98 |
| bronzef. Hell, bronze light | 2.7 | 46152-4 | 26.98 |
| bronzef. Dunkel, bronze dark | 1.0 | 46164-7 | 9.98 |
| bronzef. Dunkel, bronze dark | 2.7 | 46166-1 | 26.98 |
| gold hell, gold light | 1.0 | 46448-8 | 9.10 |
| gold hell, gold light | 2.7 | 46450-1 | 24.64 |

| | |
|---------|-------|
| 46128-9 | 9.54 |
| 46130-2 | 26.02 |
| 46142-5 | 9.92 |
| 46144-9 | 27.04 |
| 46156-2 | 10.78 |
| 46158-6 | 29.40 |
| 46170-8 | 10.78 |
| 46172-2 | 29.40 |
| 46452-5 | 9.92 |
| 46454-9 | 27.04 |

Einschubp. 13,3 mm mit Nase 7mm Parkett, Alu. Elox., geb.

263

nosed insert profile for
wooden floor 13 mm,
aluminium anodized, drilled

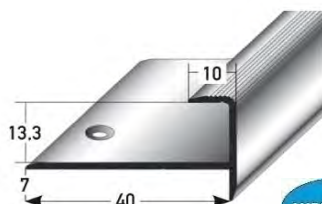

| | | | |
|------------------------------|-----|---------|-------|
| silberfarbig silver coloured | 1.0 | 46178-4 | 9.44 |
| silberfarbig silver coloured | 2.7 | 46180-7 | 25.52 |
| goldfarbiggold coloured | 1.0 | 46192-0 | 9.80 |
| goldfarbiggold coloured | 2.7 | 46194-4 | 26.50 |
| bronzef. Hell, bronze light | 1.0 | 46206-4 | 10.68 |
| bronzef. Hell, bronze light | 2.7 | 46208-8 | 28.82 |
| bronzef. Dunkel, bronze dark | 1.0 | 46220-0 | 10.68 |
| bronzef. Dunkel, bronze dark | 2.7 | 46222-4 | 28.82 |
| gold hell, gold light | 1.0 | 46458-7 | 9.80 |
| gold hell, gold light | 2.7 | 46460-0 | 26.50 |

| | |
|---------|-------|
| 46184-5 | 10.26 |
| 46186-9 | 27.92 |
| 46198-2 | 10.62 |
| 46200-2 | 28.92 |
| 46212-5 | 11.48 |
| 46214-9 | 31.26 |
| 46226-2 | 11.48 |
| 46228-6 | 31.26 |
| 46462-4 | 10.62 |
| 46464-8 | 28.92 |

Einschubp. 15,3 mm mit Nase 12mm Parkett, Alu. Elox., geb.

112

nosed insert profile for
wooden floor 15 mm,
aluminium anodized, drilled

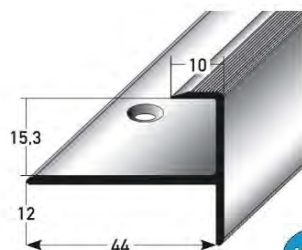

| | | | |
|------------------------------|-----|---------|-------|
| silberfarbig silver coloured | 1.0 | 37020-8 | 8.26 |
| silberfarbig silver coloured | 2.7 | 37030-7 | 22.30 |
| goldfarbiggold coloured | 1.0 | 37040-6 | 10.88 |
| goldfarbiggold coloured | 2.7 | 37050-5 | 29.40 |
| bronzef. Hell, bronze light | 1.0 | 37060-4 | 11.38 |
| bronzef. Hell, bronze light | 2.7 | 37070-3 | 30.72 |
| bronzef. Dunkel, bronze dark | 1.0 | 37080-2 | 11.38 |
| bronzef. Dunkel, bronze dark | 2.7 | 37090-1 | 30.72 |
| gold hell, gold light | 1.0 | 62210-9 | 10.88 |
| gold hell, gold light | 2.7 | 62215-4 | 29.40 |

| | |
|---------|-------|
| 37021-5 | 9.00 |
| 37031-4 | 24.60 |
| 37041-3 | 11.68 |
| 37051-2 | 31.82 |
| 37061-1 | 12.16 |
| 37071-0 | 33.14 |
| 37081-9 | 12.16 |
| 37091-8 | 33.14 |
| 62220-8 | 11.68 |
| 62230-7 | 31.82 |



| |
|---|
| Befestigungsschenkel ausklinken attachment flanges notched |
| Befestigungsschenkel ausklinken und biegen attachment flanges notched and bent |

| Art./ref. | €/m |
|---------------------------|------|
| 22240-8 | 5.72 |
| auf Anfrage on reqUest | |

5. EINSCHUB- & ANSTOßPROFILE/ 5. INSERT PROFILES

Andere Eloxalfarben siehe
Abschnitt 6, Lieferzeit 14 Tage/
other anodized colours see section 6,
delivery time 14 days

| Profi-Pack à 10 StUeck im Bund | | | |
|-------------------------------------|-----------|-----------|-------------|
| professional packin 101 pcs. | | | |
| Farbe/colour | L / l (m) | Art./ref. | €/Stk./pcs. |

| SB-Pack incl. Schr./ DUebel; VE 20 Stk. | |
|---|-------------|
| self-service-pack with screws/ dowels; à 20 pcs. | |
| Art./ref. | €/Stk./pcs. |

Treppen.Laminat 20 x 33 x 8,5 mm, Alu. Elox., 2 x geb.

stair nosing for laminate
20 x 33 x 8,5 mm,
aluminium anodized, 2 x drilled

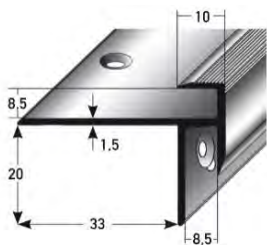

| | | | |
|------------------------------|------------|----------------|--------------|
| silberfarbig silver coloured | <u>1.0</u> | <u>29100-8</u> | <u>13.28</u> |
| silberfarbig silver coloured | <u>2.5</u> | <u>29110-7</u> | <u>33.24</u> |
| goldfarbiggold coloured | <u>1.0</u> | <u>29115-2</u> | <u>13.82</u> |
| goldfarbiggold coloured | <u>2.5</u> | <u>29125-1</u> | <u>34.58</u> |
| bronzef. Hell,bronze light | <u>1.0</u> | <u>29130-5</u> | <u>14.92</u> |
| bronzef. Hell,bronze light | <u>2.5</u> | <u>29140-4</u> | <u>37.34</u> |
| bronzef. Dunkel, bronze dark | <u>1.0</u> | <u>29145-9</u> | <u>14.92</u> |
| bronzef. Dunkel, bronze dark | <u>2.5</u> | <u>29155-8</u> | <u>37.34</u> |
| gold hell, gold light | <u>1.0</u> | <u>62300-7</u> | <u>13.82</u> |
| gold hell, gold light | <u>2.5</u> | <u>62310-6</u> | <u>34.58</u> |

| | |
|----------------|--------------|
| <u>29101-5</u> | <u>14.08</u> |
| <u>29111-4</u> | <u>35.64</u> |
| <u>29116-9</u> | <u>14.62</u> |
| <u>29126-8</u> | <u>36.98</u> |
| <u>29131-2</u> | <u>15.74</u> |
| <u>29141-1</u> | <u>39.78</u> |
| <u>29146-6</u> | <u>15.74</u> |
| <u>29156-5</u> | <u>39.78</u> |
| <u>62315-1</u> | <u>14.58</u> |
| <u>62320-5</u> | <u>36.98</u> |

Treppen.Parkett 20 x 33 x 10 mm, Alu. Elox., 2 x geb.

stair nosing for parqUet
20 x 33 x 10 mm,
aluminium anodized, 2 x drilled

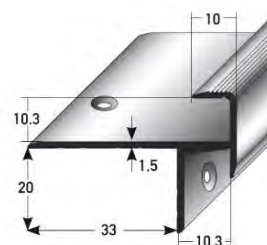

| | | | |
|------------------------------|------------|----------------|--------------|
| silberfarbig silver coloured | <u>1.0</u> | <u>46288-0</u> | <u>13.54</u> |
| silberfarbig silver coloured | <u>2.5</u> | <u>46290-3</u> | <u>33.84</u> |
| goldfarbiggold coloured | <u>1.0</u> | <u>46298-9</u> | <u>14.02</u> |
| goldfarbiggold coloured | <u>2.5</u> | <u>46300-9</u> | <u>35.04</u> |
| bronzef. Hell,bronze light | <u>1.0</u> | <u>46308-5</u> | <u>15.18</u> |
| bronzef. Hell,bronze light | <u>2.5</u> | <u>46310-8</u> | <u>37.98</u> |
| bronzef. Dunkel, bronze dark | <u>1.0</u> | <u>46318-4</u> | <u>15.18</u> |
| bronzef. Dunkel, bronze dark | <u>2.5</u> | <u>46320-7</u> | <u>37.98</u> |
| gold hell, gold light | <u>1.0</u> | <u>46408-2</u> | <u>14.02</u> |
| gold hell, gold light | <u>2.5</u> | <u>46410-5</u> | <u>35.04</u> |

| | |
|----------------|--------------|
| <u>46292-7</u> | <u>14.32</u> |
| <u>46294-1</u> | <u>36.28</u> |
| <u>46302-3</u> | <u>14.82</u> |
| <u>46304-7</u> | <u>37.44</u> |
| <u>46312-2</u> | <u>15.98</u> |
| <u>46314-6</u> | <u>40.38</u> |
| <u>46322-1</u> | <u>15.98</u> |
| <u>46324-5</u> | <u>40.38</u> |
| <u>46412-9</u> | <u>14.82</u> |
| <u>46414-3</u> | <u>37.44</u> |

Treppen.Parkett 20 x 33 x 13 mm, Alu. Elox., 2 x geb.

stair nosing for parqUet
20 x 33 x 13 mm,
aluminium anodized, 2 x drilled

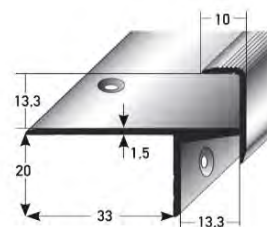

| | | | |
|------------------------------|------------|----------------|--------------|
| silberfarbig silver coloured | <u>1.0</u> | <u>46328-3</u> | <u>14.42</u> |
| silberfarbig silver coloured | <u>2.5</u> | <u>46330-6</u> | <u>36.02</u> |
| goldfarbiggold coloured | <u>1.0</u> | <u>46338-2</u> | <u>14.92</u> |
| goldfarbiggold coloured | <u>2.5</u> | <u>46340-5</u> | <u>37.34</u> |
| bronzef. Hell,bronze light | <u>1.0</u> | <u>46348-1</u> | <u>16.16</u> |
| bronzef. Hell,bronze light | <u>2.5</u> | <u>46350-4</u> | <u>40.38</u> |
| bronzef. Dunkel, bronze dark | <u>1.0</u> | <u>46358-0</u> | <u>16.16</u> |
| bronzef. Dunkel, bronze dark | <u>2.5</u> | <u>46360-3</u> | <u>40.38</u> |
| gold hell, gold light | <u>1.0</u> | <u>46418-1</u> | <u>14.92</u> |
| gold hell, gold light | <u>2.5</u> | <u>46420-4</u> | <u>37.34</u> |

| | |
|----------------|--------------|
| <u>46332-0</u> | <u>15.22</u> |
| <u>46334-4</u> | <u>38.46</u> |
| <u>46342-9</u> | <u>15.74</u> |
| <u>46344-3</u> | <u>39.78</u> |
| <u>46352-8</u> | <u>16.96</u> |
| <u>46354-2</u> | <u>42.80</u> |
| <u>46362-7</u> | <u>16.96</u> |
| <u>46364-1</u> | <u>42.80</u> |
| <u>46422-8</u> | <u>15.74</u> |
| <u>46424-2</u> | <u>39.78</u> |

Treppen.Parkett 20 x 33 x 15 mm, Alu. Elox., 2 x geb.

stair nosing for parqUet
20 x 33 x 15 mm,
aluminium anodized,
2 x drilled

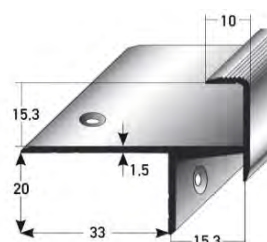

| | | | |
|------------------------------|------------|----------------|--------------|
| silberfarbig silver coloured | <u>1.0</u> | <u>46368-9</u> | <u>14.80</u> |
| silberfarbig silver coloured | <u>2.5</u> | <u>46370-2</u> | <u>36.98</u> |
| goldfarbiggold coloured | <u>1.0</u> | <u>46378-8</u> | <u>15.32</u> |
| goldfarbiggold coloured | <u>2.5</u> | <u>46380-1</u> | <u>38.30</u> |
| bronzef. Hell,bronze light | <u>1.0</u> | <u>46388-7</u> | <u>16.18</u> |
| bronzef. Hell,bronze light | <u>2.5</u> | <u>46390-0</u> | <u>41.50</u> |
| bronzef. Dunkel, bronze dark | <u>1.0</u> | <u>46398-6</u> | <u>16.18</u> |
| bronzef. Dunkel, bronze dark | <u>2.5</u> | <u>46400-6</u> | <u>41.50</u> |
| gold hell, gold light | <u>1.0</u> | <u>46428-0</u> | <u>15.32</u> |
| gold hell, gold light | <u>2.5</u> | <u>46430-3</u> | <u>38.30</u> |

| | |
|----------------|--------------|
| <u>46372-6</u> | <u>15.58</u> |
| <u>46374-0</u> | <u>39.42</u> |
| <u>46382-5</u> | <u>16.14</u> |
| <u>46384-9</u> | <u>40.74</u> |
| <u>46392-4</u> | <u>17.42</u> |
| <u>46394-8</u> | <u>43.94</u> |
| <u>46402-0</u> | <u>17.42</u> |
| <u>46404-4</u> | <u>43.94</u> |
| <u>46432-7</u> | <u>16.14</u> |
| <u>46434-1</u> | <u>40.74</u> |

7. SYSTEMPROFILE AUS ALUMINIUM & EDELSTAHL FUeR 4-24mm BELaeGE 7. SYSTEM PROFILES OUT OF ALUMINIUM + STAINLESS STEEL FOR 4-24mm FLOORINGS

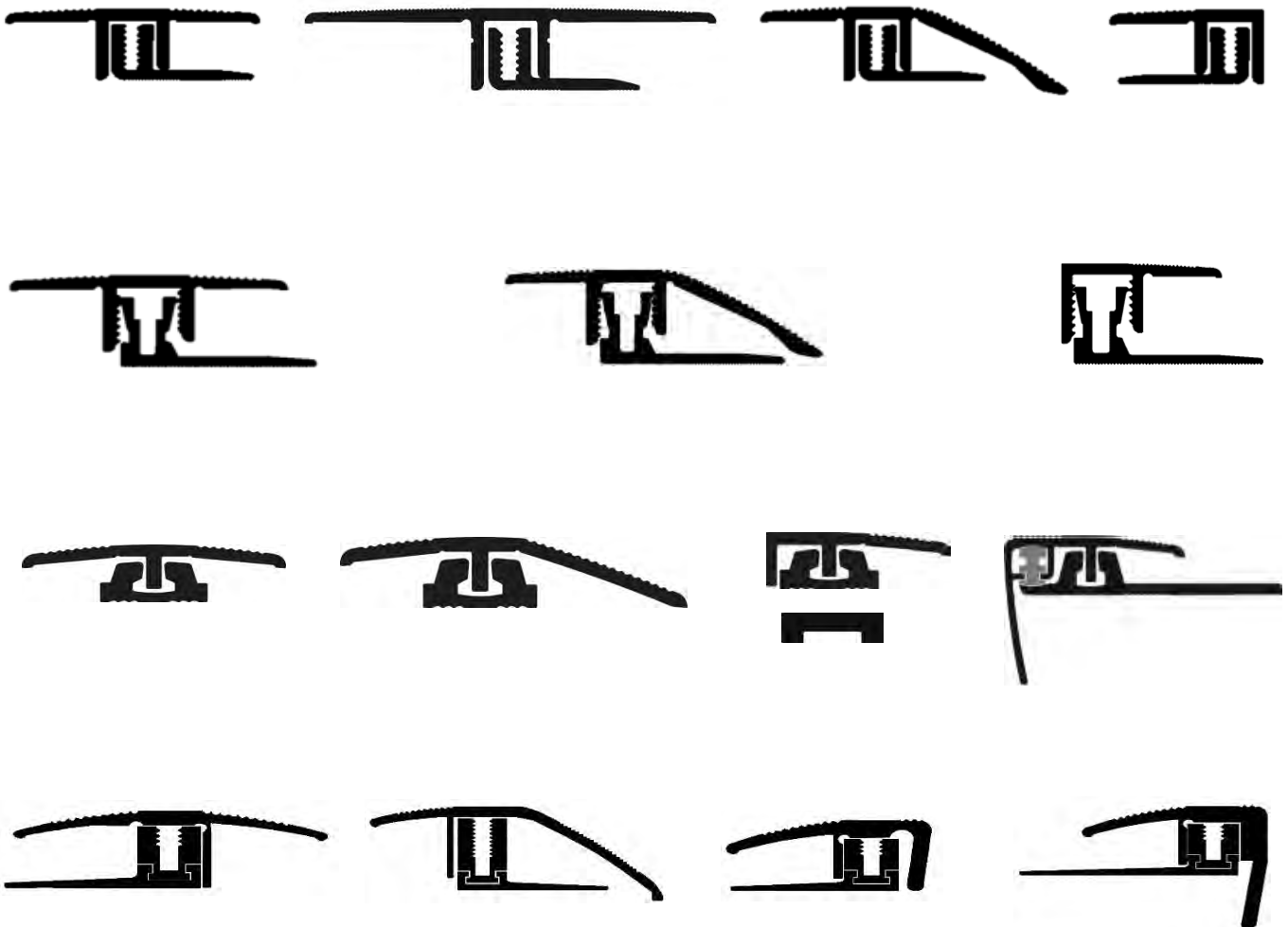

MINI-APL-System 5 - 9 mm, 2-teilig

MINI-APL-system 5 - 9 mm, 2 parts

306

MINI-APL-Uebergangsp. 5 - 9 mm, Alu., geb.

MINI-APL-edge 5 - 9 mm, aluminium, drilled

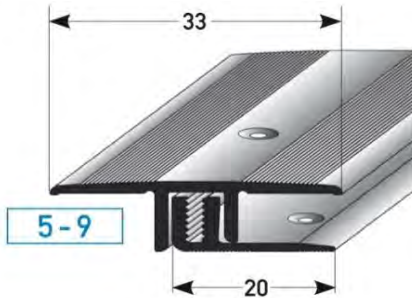

Extra Schrauben siehe Abschnitt 12.
screws, see section 12.

Extra

SB-Pack incl. Schrauben + DÜbel; VE 20 Stk.

self-service-pack with screws + dowels; à 20 pcs.

| Farbe/colour | L / l (m) | Art./ref. | €/Stk./pcs. |
|--------------------------------|-----------|-----------|-------------|
| silver coloured | 0,9 | 48776-0 | 15,02 |
| silver coloured | 1,0 | 48778-4 | 16,68 |
| silver coloured | 2,7 | 48780-7 | 45,02 |
| gold coloured | 0,9 | 48782-1 | 15,14 |
| gold coloured | 1,0 | 48784-5 | 16,82 |
| gold coloured | 2,7 | 48786-9 | 45,42 |
| bronze light col. | 0,9 | 48788-3 | 15,88 |
| bronze light col. | 1,0 | 48790-6 | 17,64 |
| bronze light col. | 2,7 | 48792-0 | 47,66 |
| bronze dark col. | 0,9 | 48794-4 | 15,88 |
| bronze dark col. | 1,0 | 48796-8 | 17,64 |
| bronze dark col. | 2,7 | 48798-2 | 47,66 |
| gold hell,gold light | 0,9 | 48800-2 | 15,14 |
| gold hell,gold light | 1,0 | 48802-6 | 16,82 |
| gold hell,gold light | 2,7 | 48804-0 | 45,42 |
| edelstahlf. Stainl. steel col. | 0,9 | 48806-4 | 15,88 |
| edelstahlf. Stainl. steel col. | 1,0 | 48808-8 | 17,64 |
| edelstahlf. Stainl. steel col. | 2,7 | 48810-1 | 47,66 |

APL-System 7 - 15 mm, 2-teilig

APL-system 7 - 15 mm, 2 parts

255

APL-Uebergangprofil 7-15 mm , Alu., geb.

APL-edge 7 - 15 mm, aluminium, drilled

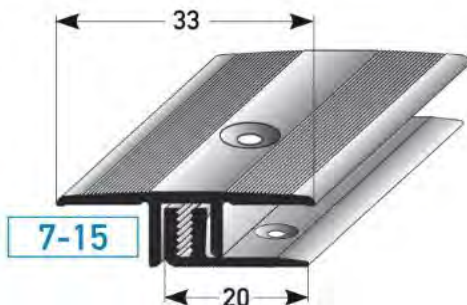

Extra Schrauben siehe Abschnitt 12.
screws, see section 12.

Extra

SB-Pack incl. Schrauben + DÜbel; VE 20 Stk.

self-service-pack with screws + dowels; à 20 pcs.

| Farbe/colour | L / l (m) | Art./ref. | €/Stk./pcs. |
|--------------------------------|-----------|-----------|-------------|
| silver coloured | 0,9 | 45944-6 | 13,80 |
| silver coloured | 1,0 | 45824-1 | 15,32 |
| silver coloured | 2,7 | 45800-5 | 41,36 |
| gold coloured | 0,9 | 45946-0 | 13,90 |
| gold coloured | 1,0 | 45826-5 | 15,46 |
| gold coloured | 2,7 | 45802-9 | 41,78 |
| bronze light col. | 0,9 | 45950-7 | 14,66 |
| bronze light col. | 1,0 | 45830-2 | 16,28 |
| bronze light col. | 2,7 | 45806-7 | 44,00 |
| bronze dark col. | 0,9 | 45952-1 | 14,66 |
| bronze dark col. | 1,0 | 45832-6 | 16,28 |
| bronze dark col. | 2,7 | 45808-1 | 44,00 |
| gold hell,gold light | 0,9 | 45948-4 | 13,90 |
| gold hell,gold light | 1,0 | 45828-9 | 15,46 |
| gold hell,gold light | 2,7 | 45804-3 | 41,78 |
| edelstahlf. Stainl. steel col. | 0,9 | 45964-4 | 14,66 |
| edelstahlf. Stainl. steel col. | 1,0 | 45844-9 | 16,28 |
| edelstahlf. Stainl. steel col. | 2,7 | 45820-3 | 44,00 |
| Buche,beech | 0,9 | 45954-5 | 18,86 |
| Buche,beech | 1,0 | 45834-0 | 20,96 |
| Buche,beech | 2,7 | 45810-4 | 56,56 |
| Eiche,oak | 0,9 | 45956-9 | 18,86 |
| Eiche,oak | 1,0 | 45836-4 | 20,96 |
| Eiche,oak | 2,7 | 45812-8 | 56,56 |
| Ahorn , maple | 0,9 | 45958-3 | 18,86 |
| Ahorn , maple | 1,0 | 45838-8 | 20,96 |
| Ahorn , maple | 2,7 | 45814-2 | 56,56 |
| Kirschbaum, cherry wood | 0,9 | 45960-6 | 18,86 |
| Kirschbaum, cherry wood | 1,0 | 45840-1 | 20,96 |
| Kirschbaum, cherry wood | 2,7 | 45816-6 | 56,56 |
| Eiche rustikal, rustic oak | 0,9 | 45962-0 | 18,86 |
| Eiche rustikal, rustic oak | 1,0 | 45842-5 | 20,96 |
| Eiche rustikal, rustic oak | 2,7 | 45818-0 | 56,56 |

Holzdekorfolie/ wood decor

Grundprofilerhöhung +8 mm, siehe Seite 80

higher basic profile +8 mm,
see page 80

40 mm breites APL-Grundprofil fUer 7 - 15 mm Belaege, siehe Seite 80

40 mm APL-basic profile for 7-15 mm flooring, see page 80



APL-System 7 - 15 mm, 2-teilig

APL-system 7 - 15 mm, 2 parts

499 APL-Uebergangprofil
50 mm extrabreit,
7 - 15 mm, Aluminium, gebohrt

APL-edge extra wide, 7 - 15 mm,
 aluminium, drilled

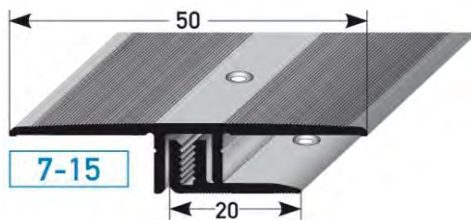

Extra Schrauben siehe Abschnitt 12.
 Extra screws, see section 12.

| SB-Pack incl. Schrauben + Duebel; VE 20 Stk. | | | |
|---|---------------------|-------------------------|-----------------------|
| self-service-pack with screws + dowels; à 20 pcs. | | | |
| Farbe/colour | L / l (m) | Art./ref. | €/Stk./pcs. |
| silver coloured | 0,9 | 71356-2 | 14,50 |
| silver coloured | 1,0 | 71358-6 | 16,10 |
| silver coloured | 2,7 | 71360-9 | 43,48 |
| gold coloured | 0,9 | 71362-3 | 14,80 |
| gold coloured | 1,0 | 71364-7 | 16,44 |
| gold coloured | 2,7 | 71366-1 | 44,38 |
| bronze light col. | 0,9 | 71368-5 | 15,92 |
| bronze light col. | 1,0 | 71370-8 | 17,68 |
| bronze light col. | 2,7 | 71372-2 | 47,74 |
| bronze dark col. | 0,9 | 71374-6 | 15,92 |
| bronze dark col. | 1,0 | 71376-0 | 17,68 |
| bronze dark col. | 2,7 | 71378-4 | 47,74 |
| gold hell,gold light | 0,9 | 71380-7 | 14,80 |
| gold hell,gold light | 1,0 | 71382-1 | 16,44 |
| gold hell,gold light | 2,7 | 71384-5 | 44,38 |
| edelstahlf. Stainl. steel col. | 0,9 | 71386-9 | 15,92 |
| edelstahlf. Stainl. steel col. | 1,0 | 71388-3 | 17,68 |
| edelstahlf. Stainl. steel col. | 2,7 | 71390-6 | 47,74 |

497 40 mm breites APL-Grundprofil fUer 7 - 15 mm Belaege, Aluminium, gebohrt

40 mm APL-basic profile
 for 7-15 mm flooring,
 aluminium, drilled



| L / l (m) | Art./ref. | €/Stk./pcs. |
|---------------------|-------------------------|-----------------------|
| 2,7 | 71350-0 | 15,66 |

498 Grundprofilerhöhung +8 mm, Aluminium, fUer APL- & SLP-System,

2x gebohrt, inkl. Schrauben

basic profile increase +8 mm,
 aluminium, for APL + SLP system,
 2x drilled, incl. screws

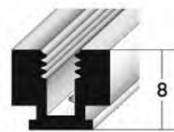

| L / l (m) | Art./ref. | €/Stk./pcs. |
|------------------------|-------------------------|----------------------|
| 0,06 m | 71396-8 | 3,12 |

MINI-APL-System 5 - 9 mm, 2-teilig

MINI-APL-system 5 - 9 mm, 2 parts

307

MINI-APL-Höhenausgleichsprofil

5 - 9 mm, Aluminium, gebohrt

MINI-APL-height levelling 5 - 9 mm, aluminium, drilled

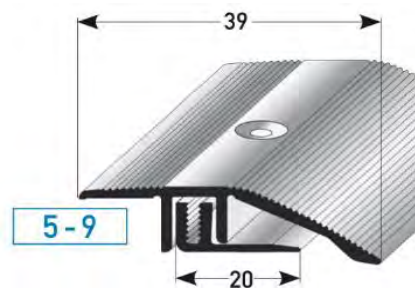

Extra Schrauben siehe Abschnitt 12.
Extra screws, see section 12.

SB-Pack incl. Schrauben + DÜbel; VE 20 Stk.

self-service-pack with screws + dowels; à 20 pcs.

| Farbe/colour | L / l (m) | Art./ref. | €/Stk./pcs. |
|--------------------------------|-----------|-----------|-------------|
| silver coloured | 0,9 | 48856-9 | 17,12 |
| silver coloured | 1,0 | 48858-3 | 19,02 |
| silver coloured | 2,7 | 48860-6 | 51,36 |
| gold coloured | 0,9 | 48862-0 | 17,16 |
| gold coloured | 1,0 | 48864-4 | 19,08 |
| gold coloured | 2,7 | 48866-8 | 51,52 |
| bronze light col. | 0,9 | 48868-2 | 18,10 |
| bronze light col. | 1,0 | 48870-5 | 20,14 |
| bronze light col. | 2,7 | 48872-9 | 54,36 |
| bronze dark col. | 0,9 | 48874-3 | 18,10 |
| bronze dark col. | 1,0 | 48876-7 | 20,14 |
| bronze dark col. | 2,7 | 48878-1 | 54,36 |
| gold hell,gold light | 0,9 | 48880-4 | 17,16 |
| gold hell,gold light | 1,0 | 48882-8 | 19,08 |
| gold hell,gold light | 2,7 | 48884-2 | 51,52 |
| edelstahlf. Stainl. steel col. | 0,9 | 48886-6 | 18,10 |
| edelstahlf. Stainl. steel col. | 1,0 | 48888-0 | 20,14 |
| edelstahlf. Stainl. steel col. | 2,7 | 48890-3 | 54,36 |

APL-System 7 - 15 mm, 2-teilig

APL-system 7 - 15 mm, 2 parts

256

APL-Höhenausgleichsprofil

7 - 15 mm, Aluminium, gebohrt

APL-height levelling 7 - 15 mm, aluminium, drilled

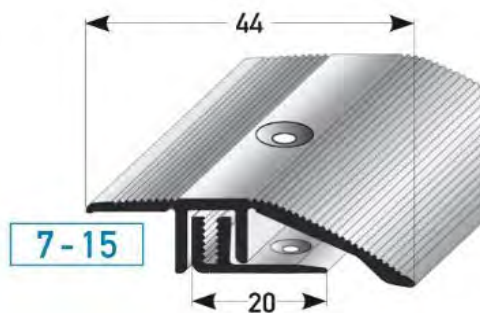

Extra Schrauben siehe Abschnitt 12.
Extra screws, see section 12.

SB-Pack incl. Schrauben + DÜbel; VE 20 Stk.

self-service-pack with screws + dowels; à 20 pcs.

| Farbe/colour | L / l (m) | Art./ref. | €/Stk./pcs. |
|--------------------------------|-----------|-----------|-------------|
| silver coloured | 0,9 | 45966-8 | 15,90 |
| silver coloured | 1,0 | 45872-2 | 17,66 |
| silver coloured | 2,7 | 45848-7 | 47,68 |
| gold coloured | 0,9 | 45968-2 | 15,96 |
| gold coloured | 1,0 | 45874-6 | 17,70 |
| gold coloured | 2,7 | 45850-0 | 47,86 |
| bronze light col. | 0,9 | 45972-9 | 16,90 |
| bronze light col. | 1,0 | 45878-4 | 18,78 |
| bronze light col. | 2,7 | 45854-8 | 50,70 |
| bronze dark col. | 0,9 | 45974-3 | 16,90 |
| bronze dark col. | 1,0 | 45880-7 | 18,78 |
| bronze dark col. | 2,7 | 45856-2 | 50,70 |
| gold hell,gold light | 0,9 | 45970-5 | 15,96 |
| gold hell,gold light | 1,0 | 45876-0 | 17,70 |
| gold hell,gold light | 2,7 | 45852-4 | 47,86 |
| edelstahlf. Stainl. steel col. | 0,9 | 45986-6 | 16,90 |
| edelstahlf. Stainl. steel col. | 1,0 | 45892-0 | 18,78 |
| edelstahlf. Stainl. steel col. | 2,7 | 45868-5 | 50,70 |

Extra Schrauben siehe Abschnitt 12.
Extra screws, see section 12.

Grundprofilerhöhung +8 mm, siehe Seite 80

higher basic profile +8 mm,
see page 80

Holzdekorfolie/ wood decor

| | | | |
|----------------------------|-----|---------|-------|
| Buche,beech | 0,9 | 45976-7 | 20,98 |
| Buche,beech | 1,0 | 45882-1 | 23,28 |
| Buche,beech | 2,7 | 45858-6 | 62,88 |
| Eiche,oak | 0,9 | 45978-1 | 20,98 |
| Eiche,oak | 1,0 | 45884-5 | 23,28 |
| Eiche,oak | 2,7 | 45860-9 | 62,88 |
| Ahorn , maple | 0,9 | 45980-4 | 20,98 |
| Ahorn , maple | 1,0 | 45886-9 | 23,28 |
| Ahorn , maple | 2,7 | 45862-3 | 62,88 |
| Kirschbaum, cherry wood | 0,9 | 45982-8 | 20,98 |
| Kirschbaum, cherry wood | 1,0 | 45888-3 | 23,28 |
| Kirschbaum, cherry wood | 2,7 | 45864-7 | 62,88 |
| Eiche rustikal, rustic oak | 0,9 | 45984-2 | 20,98 |
| Eiche rustikal, rustic oak | 1,0 | 45890-6 | 23,28 |
| Eiche rustikal, rustic oak | 2,7 | 45866-1 | 62,88 |

40 mm breites APL-Grundprofil fUer 7 - 15 mm Belaege, siehe Seite 80

40 mm APL-basic profile for 7-15 mm flooring, see page 80



MINI-APL-System 5 - 9 mm, 2-teilig

MINI-APL-system 5 - 9 mm, 2 parts

308 MINI-APL-Abschlussprofil

5 - 9 mm, Aluminium, gebohrt

MINI-APL-end 5 - 9 mm, aluminium, drilled

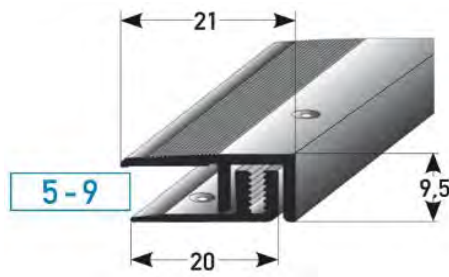

Extra Schrauben siehe Abschnitt 12.
screws, see section 12.

Extra

SB-Pack incl. Schrauben + DUEbel; VE 20 Stk.

self-service-pack with screws + dowels; à 20 pcs.

| Farbe/colour | L / l (m) | Art./ref. | €/Stk./pcs. |
|--------------------------------|-----------|-----------|-------------|
| silver coloured | 0,9 | 48936-8 | 13,96 |
| silver coloured | 1,0 | 48938-2 | 15,48 |
| silver coloured | 2,7 | 48940-5 | 41,86 |
| gold coloured | 0,9 | 48942-9 | 14,02 |
| gold coloured | 1,0 | 48944-3 | 15,58 |
| gold coloured | 2,7 | 48946-7 | 42,08 |
| bronze light col. | 0,9 | 48948-1 | 14,80 |
| bronze light col. | 1,0 | 48950-4 | 16,44 |
| bronze light col. | 2,7 | 48952-8 | 44,42 |
| bronze dark col. | 0,9 | 48954-2 | 14,80 |
| bronze dark col. | 1,0 | 48956-6 | 16,44 |
| bronze dark col. | 2,7 | 48958-0 | 44,42 |
| gold hell,gold light | 0,9 | 48960-3 | 14,02 |
| gold hell,gold light | 1,0 | 48962-7 | 15,58 |
| gold hell,gold light | 2,7 | 48964-1 | 42,08 |
| edelstahlf. Stainl. steel col. | 0,9 | 48966-5 | 14,80 |
| edelstahlf. Stainl. steel col. | 1,0 | 48968-9 | 16,44 |
| edelstahlf. Stainl. steel col. | 2,7 | 48970-2 | 44,42 |

APL-System 7 - 15 mm, 2-teilig

APL-system 7 - 15 mm, 2 parts

257 APL-Abschlussprofil

7 - 15 mm, Aluminium, gebohrt

APL-end 7 - 15 mm, aluminium, drilled

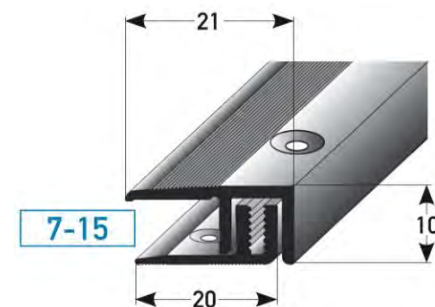

Extra Schrauben siehe Abschnitt 12.
screws, see section 12.

Extra

SB-Pack incl. Schrauben + DUEbel; VE 20 Stk.

self-service-pack with screws + dowels; à 20 pcs.

| Farbe/colour | L / l (m) | Art./ref. | €/Stk./pcs. |
|--------------------------------|-----------|-----------|-------------|
| silver coloured | 0,9 | 45988-0 | 12,74 |
| silver coloured | 1,0 | 45920-0 | 14,16 |
| silver coloured | 2,7 | 45896-8 | 38,18 |
| gold coloured | 0,9 | 45990-3 | 12,82 |
| gold coloured | 1,0 | 45922-4 | 14,24 |
| gold coloured | 2,7 | 45898-2 | 38,44 |
| bronze light col. | 0,9 | 45994-1 | 13,58 |
| bronze light col. | 1,0 | 45926-2 | 15,10 |
| bronze light col. | 2,7 | 45902-6 | 40,74 |
| bronze dark col. | 0,9 | 45996-5 | 13,58 |
| bronze dark col. | 1,0 | 45928-6 | 15,10 |
| bronze dark col. | 2,7 | 45904-0 | 40,74 |
| gold hell,gold light | 0,9 | 45992-7 | 12,82 |
| gold hell,gold light | 1,0 | 45924-8 | 14,24 |
| gold hell,gold light | 2,7 | 45900-2 | 38,44 |
| edelstahlf. Stainl. steel col. | 0,9 | 46008-4 | 13,58 |
| edelstahlf. Stainl. steel col. | 1,0 | 45940-8 | 15,10 |
| edelstahlf. Stainl. steel col. | 2,7 | 45916-3 | 40,74 |
| Buche,beech | 0,9 | 45998-9 | 17,78 |
| Buche,beech | 1,0 | 45930-9 | 19,74 |
| Buche,beech | 2,7 | 45906-4 | 53,34 |
| Eiche,oak | 0,9 | 46000-8 | 17,78 |
| Eiche,oak | 1,0 | 45932-3 | 19,74 |
| Eiche,oak | 2,7 | 45908-8 | 53,34 |
| Ahorn , maple | 0,9 | 46002-2 | 17,78 |
| Ahorn , maple | 1,0 | 45934-7 | 19,74 |
| Ahorn , maple | 2,7 | 45910-1 | 53,34 |
| Kirschbaum, cherry wood | 0,9 | 46004-6 | 17,78 |
| Kirschbaum, cherry wood | 1,0 | 45936-1 | 19,74 |
| Kirschbaum, cherry wood | 2,7 | 45912-5 | 53,34 |
| Eiche rustikal, rustic oak | 0,9 | 46006-0 | 17,78 |
| Eiche rustikal, rustic oak | 1,0 | 45938-5 | 19,74 |
| Eiche rustikal, rustic oak | 2,7 | 45914-9 | 53,34 |

40 mm breites APL-Grundprofil fUer 7 - 15 mm Belaege,

siehe Seite 80

40 mm APL-basic profile for 7-15 mm flooring, see page 80



MINI-APL-KLICK-System 4-7 mm, 2-teilig

MINI-APL-CLICK-system 4-7 mm, 2-teilig/ 2 parts

447 **MINI-APL-Klick-Uebergangprofil**

**4 - 7 mm, zum Klicken,
Aluminium**

MINI-APL-click-edge 4 - 7 mm, to click, aluminium

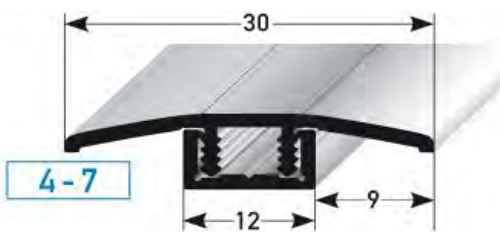

| SB-Pack incl. Schrauben + DUEbel; VE 20 Stk. | | | |
|---|-----------|-----------|-------------|
| self-service-pack with screws + dowels; à 20 pcs. | | | |
| Farbe/colour | L / l (m) | Art./ref. | €/Stk./pcs. |
| silver coloured | 0.9 | 68396-4 | 12,80 |
| silver coloured | 1.0 | 68398-8 | 14,22 |
| silver coloured | 2.7 | 68400-8 | 38,42 |
| gold coloured | 0.9 | 68402-2 | 13,16 |
| gold coloured | 1.0 | 68404-6 | 14,62 |
| gold coloured | 2.7 | 68406-0 | 39,48 |
| bronze light col. | 0.9 | 68408-4 | 14,30 |
| bronze light col. | 1.0 | 68410-7 | 15,90 |
| bronze light col. | 2.7 | 68412-1 | 42,94 |
| bronze dark col. | 0.9 | 68414-5 | 14,30 |
| bronze dark col. | 1.0 | 68416-9 | 15,90 |
| bronze dark col. | 2.7 | 68418-3 | 42,94 |
| gold hell,gold light | 0.9 | 68420-6 | 13,16 |
| gold hell,gold light | 1.0 | 68422-0 | 14,62 |
| gold hell,gold light | 2.7 | 68424-4 | 39,48 |
| edelstahlf. Stainl. steel col. | 0.9 | 68426-8 | 14,30 |
| edelstahlf. Stainl. steel col. | 1.0 | 68428-2 | 15,90 |
| edelstahlf. Stainl. steel col. | 2.7 | 68430-5 | 42,94 |

APL-KLICK-System 7-10 mm, 2-teilig

APL-CLICK-system 7-10 mm, 2-teilig/ 2 parts

272

APL-Klick-Uebergangprofil
**7 - 10 mm, zum Klicken,
Aluminium**

APL-click-edge 7 - 10 mm, to click, aluminium

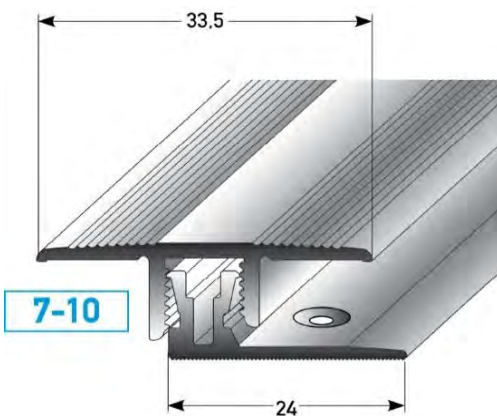

| SB-Pack incl. Schrauben + DUEbel; VE 20 Stk. | | | |
|---|-----------|-----------|-------------|
| self-service-pack with screws + dowels; à 20 pcs. | | | |
| Farbe/colour | L / l (m) | Art./ref. | €/Stk./pcs. |
| silver coloured | 0.9 | 48300-7 | 13,68 |
| silver coloured | 1.0 | 48302-1 | 15,22 |
| silver coloured | 2.7 | 48304-5 | 41,06 |
| gold coloured | 0.9 | 48306-9 | 13,82 |
| gold coloured | 1.0 | 48308-3 | 15,34 |
| gold coloured | 2.7 | 48310-6 | 41,44 |
| bronze light col. | 0.9 | 48312-0 | 14,54 |
| bronze light col. | 1.0 | 48314-4 | 16,18 |
| bronze light col. | 2.7 | 48316-8 | 43,66 |
| bronze dark col. | 0.9 | 48318-2 | 14,54 |
| bronze dark col. | 1.0 | 48320-5 | 16,18 |
| bronze dark col. | 2.7 | 48322-9 | 43,66 |
| gold hell,gold light | 0.9 | 48324-3 | 13,82 |
| gold hell,gold light | 1.0 | 48326-7 | 15,34 |
| gold hell,gold light | 2.7 | 48328-1 | 41,44 |
| edelstahlf. Stainl. steel col. | 0.9 | 48330-4 | 14,54 |
| edelstahlf. Stainl. steel col. | 1.0 | 48332-8 | 16,18 |
| edelstahlf. Stainl. steel col. | 2.7 | 48334-2 | 43,66 |

FUEr 7-10 mm-Belaege + 2 mm Daemmung
for 7-10 mm coverings + 2 mm insulation

Holzdekorfolie/ wood decor

| | | | |
|----------------------------|-----|---------|-------|
| Buche,beech | 0.9 | 48336-6 | 18,76 |
| Buche,beech | 1.0 | 48338-0 | 20,84 |
| Buche,beech | 2.7 | 48340-3 | 56,28 |
| Eiche,oak | 0.9 | 48342-7 | 18,76 |
| Eiche,oak | 1.0 | 48344-1 | 20,84 |
| Eiche,oak | 2.7 | 48346-5 | 56,28 |
| Ahorn , maple | 0.9 | 48348-9 | 18,76 |
| Ahorn , maple | 1.0 | 48350-2 | 20,84 |
| Ahorn , maple | 2.7 | 48352-6 | 56,28 |
| Kirschbaum, cherry wood | 0.9 | 48354-0 | 18,76 |
| Kirschbaum, cherry wood | 1.0 | 48356-4 | 20,84 |
| Kirschbaum, cherry wood | 2.7 | 48358-8 | 56,28 |
| Eiche rustikal, rustic oak | 0.9 | 48360-1 | 18,76 |
| Eiche rustikal, rustic oak | 1.0 | 48362-5 | 20,84 |
| Eiche rustikal, rustic oak | 2.7 | 48364-9 | 56,28 |

APL-KLICK-System 11-15 mm, 2-teilig

APL-CLICK-system 11-15 mm, 2 parts

273

APL-Klick-Uebergangprofil 11 - 15 mm, zum Klicken, Aluminium

APL-click-edge 11 - 15 mm, to click,
aluminium

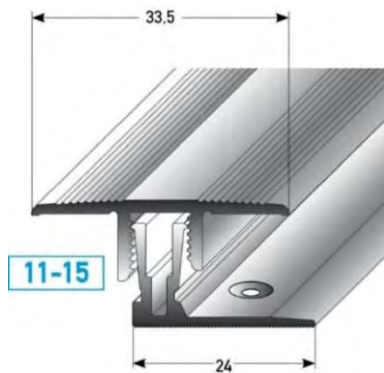

FUer 11-15 mm-Belaege + 2 mm
Daemmung for 11-15 mm
coverings + 2 mm insulation

Holzdekorfolie/ wood decor

| SB-Pack incl. Schrauben + DUEbel; VE 20 Stk. | | | |
|---|-----------|-----------|-------------|
| self-service-pack with screws + dowels; à 20 pcs. | | | |
| Farbe/colour | L / l (m) | Art./ref. | €/Stk./pcs. |
| silver coloured | 0,9 | 48378-6 | 14,54 |
| silver coloured | 1,0 | 48380-9 | 16,18 |
| silver coloured | 2,7 | 48382-3 | 43,66 |
| gold coloured | 0,9 | 48384-7 | 14,68 |
| gold coloured | 1,0 | 48386-1 | 16,30 |
| gold coloured | 2,7 | 48388-5 | 44,06 |
| bronze light col. | 0,9 | 48390-8 | 15,42 |
| bronze light col. | 1,0 | 48392-2 | 17,14 |
| bronze light col. | 2,7 | 48394-6 | 46,28 |
| bronze dark col. | 0,9 | 48396-0 | 15,42 |
| bronze dark col. | 1,0 | 48398-4 | 17,14 |
| bronze dark col. | 2,7 | 48400-4 | 46,28 |
| gold hell,gold light | 0,9 | 48402-8 | 14,68 |
| gold hell,gold light | 1,0 | 48404-2 | 16,30 |
| gold hell,gold light | 2,7 | 48406-6 | 44,06 |
| edelstahlf. Stainl. steel col. | 0,9 | 48408-0 | 15,42 |
| edelstahlf. Stainl. steel col. | 1,0 | 48410-3 | 17,14 |
| edelstahlf. Stainl. steel col. | 2,7 | 48412-7 | 46,28 |
| Buche,beech | 0,9 | 48414-1 | 19,64 |
| Buche,beech | 1,0 | 48416-5 | 21,82 |
| Buche,beech | 2,7 | 48418-9 | 58,90 |
| Eiche,oak | 0,9 | 48420-2 | 19,64 |
| Eiche,oak | 1,0 | 48422-6 | 21,82 |
| Eiche,oak | 2,7 | 48424-0 | 58,90 |
| Ahorn , maple | 0,9 | 48426-4 | 19,64 |
| Ahorn , maple | 1,0 | 48428-8 | 21,82 |
| Ahorn , maple | 2,7 | 48430-1 | 58,90 |
| Kirschbaum, cherry wood | 0,9 | 48432-5 | 19,64 |
| Kirschbaum, cherry wood | 1,0 | 48434-9 | 21,82 |
| Kirschbaum, cherry wood | 2,7 | 48436-3 | 58,90 |
| Eiche rustikal, rustic oak | 0,9 | 48438-7 | 19,64 |
| Eiche rustikal, rustic oak | 1,0 | 48440-0 | 21,82 |
| Eiche rustikal, rustic oak | 2,7 | 48442-4 | 58,90 |

APL-KLICK-System 15-24 mm, 2-teilig

APL-CLICK-system 15-24 mm, 2 parts

448

APL-Klick-Uebergangprofil 15 - 24 mm, zum Klicken, Aluminium

APL-click-edge 15 - 24 mm, to click,
aluminium

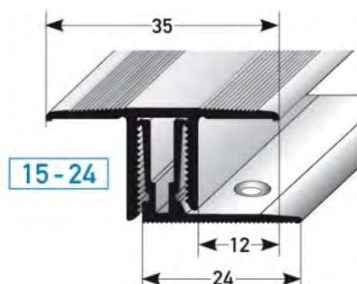

FUer 15-24 mm-Belaege + 2 mm Daemmung
for 15-24 mm coverings + 2 mm insulation

| SB-Pack incl. Schrauben + DUEbel; VE 20 Stk. | | | |
|---|-----------|-----------|-------------|
| self-service-pack with screws + dowels; à 20 pcs. | | | |
| Farbe/colour | L / l (m) | Art./ref. | €/Stk./pcs. |
| silver coloured | 0,9 | 68440-4 | 18,14 |
| silver coloured | 1,0 | 68442-8 | 20,16 |
| silver coloured | 2,7 | 68444-2 | 54,44 |
| gold coloured | 0,9 | 68446-6 | 18,26 |
| gold coloured | 1,0 | 68448-0 | 20,28 |
| gold coloured | 2,7 | 68450-3 | 54,78 |
| bronze light col. | 0,9 | 68452-7 | 19,26 |
| bronze light col. | 1,0 | 68454-1 | 21,40 |
| bronze light col. | 2,7 | 68456-5 | 57,78 |
| bronze dark col. | 0,9 | 68458-9 | 19,26 |
| bronze dark col. | 1,0 | 68460-2 | 21,40 |
| bronze dark col. | 2,7 | 68462-6 | 57,78 |
| gold hell,gold light | 0,9 | 68464-0 | 18,26 |
| gold hell,gold light | 1,0 | 68466-4 | 20,28 |
| gold hell,gold light | 2,7 | 68468-8 | 54,78 |
| edelstahlf. Stainl. steel col. | 0,9 | 68470-1 | 19,26 |
| edelstahlf. Stainl. steel col. | 1,0 | 68472-5 | 21,40 |
| edelstahlf. Stainl. steel col. | 2,7 | 68474-9 | 57,78 |

MINI-APL-KLICK-System 4-7 mm, 2-teilig

MINI-APL-CLICK-system 4-7 mm, 2 parts

449

MINI-APL-Klick- Höhenausgleichsprofil 4 - 7 mm, zum Klicken, Aluminium

MINI-APL-click-height levelling 4 - 7 mm, to click, aluminium

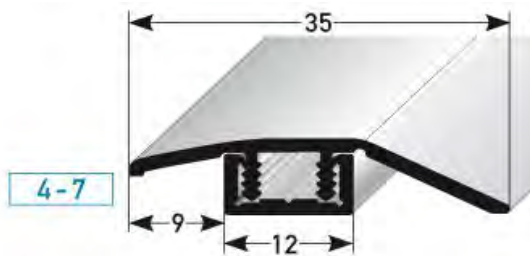

| SB-Pack incl. Schrauben + DUEbel; VE 20 Stk. self-service-pack with screws + dowels; à 20 pcs. | | | |
|---|-----------|-----------|-------------|
| Farbe/colour | L / l (m) | Art./ref. | €/Stk./pcs. |
| silver coloured | 0,9 | 68484-8 | 13,32 |
| silver coloured | 1,0 | 68486-2 | 14,82 |
| silver coloured | 2,7 | 68488-6 | 39,98 |
| gold coloured | 0,9 | 68490-9 | 13,70 |
| gold coloured | 1,0 | 68492-3 | 15,22 |
| gold coloured | 2,7 | 68494-7 | 41,08 |
| bronze light col. | 0,9 | 68496-1 | 14,92 |
| bronze light col. | 1,0 | 68498-5 | 16,58 |
| bronze light col. | 2,7 | 68500-5 | 44,76 |
| bronze dark col. | 0,9 | 68502-9 | 14,92 |
| bronze dark col. | 1,0 | 68504-3 | 16,58 |
| bronze dark col. | 2,7 | 68506-7 | 44,76 |
| gold hell,gold light | 0,9 | 68508-1 | 13,70 |
| gold hell,gold light | 1,0 | 68510-4 | 15,22 |
| gold hell,gold light | 2,7 | 68512-8 | 41,08 |
| edelstahlf. Stainl. steel col. | 0,9 | 68514-2 | 14,92 |
| edelstahlf. Stainl. steel col. | 1,0 | 68516-6 | 16,58 |
| edelstahlf. Stainl. steel col. | 2,7 | 68518-0 | 44,76 |

APL-KLICK-System 7-10 mm, 2-teilig

APL-CLICK-system 7-10 mm, 2 parts

274

APL-Klick- Höhenausgleichsprofil 7 - 10 mm, zum Klicken, Aluminium

APL-click-height levelling 7 - 10 mm, to click, aluminium

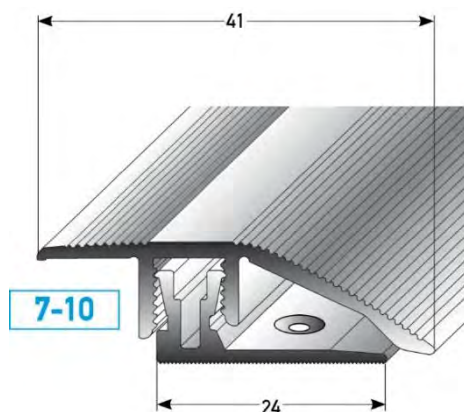

| SB-Pack incl. Schrauben + DUEbel; VE 20 Stk. self-service-pack with screws + dowels; à 20 pcs. | | | |
|---|-----------|-----------|-------------|
| Farbe/colour | L / l (m) | Art./ref. | €/Stk./pcs. |
| silver coloured | 0,9 | 48458-5 | 15,82 |
| silver coloured | 1,0 | 48460-8 | 17,56 |
| silver coloured | 2,7 | 48462-2 | 47,42 |
| gold coloured | 0,9 | 48464-6 | 15,84 |
| gold coloured | 1,0 | 48466-0 | 17,60 |
| gold coloured | 2,7 | 48468-4 | 47,52 |
| bronze light col. | 0,9 | 48470-7 | 16,80 |
| bronze light col. | 1,0 | 48472-1 | 18,68 |
| bronze light col. | 2,7 | 48474-5 | 50,40 |
| bronze dark col. | 0,9 | 48476-9 | 16,80 |
| bronze dark col. | 1,0 | 48478-3 | 18,68 |
| bronze dark col. | 2,7 | 48480-6 | 50,40 |
| gold hell,gold light | 0,9 | 48482-0 | 15,84 |
| gold hell,gold light | 1,0 | 48484-4 | 17,60 |
| gold hell,gold light | 2,7 | 48486-8 | 47,52 |
| edelstahlf. Stainl. steel col. | 0,9 | 48488-2 | 16,80 |
| edelstahlf. Stainl. steel col. | 1,0 | 48490-5 | 18,68 |
| edelstahlf. Stainl. steel col. | 2,7 | 48492-9 | 50,40 |
| Buche, beech | 0,9 | 48494-3 | 20,84 |
| Buche, beech | 1,0 | 48496-7 | 23,18 |
| Buche, beech | 2,7 | 48498-1 | 62,54 |
| Eiche, oak | 0,9 | 48500-1 | 20,84 |
| Eiche, oak | 1,0 | 48502-5 | 23,18 |
| Eiche, oak | 2,7 | 48504-9 | 62,54 |
| Ahorn , maple | 0,9 | 48506-3 | 20,84 |
| Ahorn , maple | 1,0 | 48508-7 | 23,18 |
| Ahorn , maple | 2,7 | 48510-0 | 62,54 |
| Kirschbaum, cherry wood | 0,9 | 48512-4 | 20,84 |
| Kirschbaum, cherry wood | 1,0 | 48514-8 | 23,18 |
| Kirschbaum, cherry wood | 2,7 | 48516-2 | 62,54 |
| Eiche rustikal, rustic oak | 0,9 | 48518-6 | 20,84 |
| Eiche rustikal, rustic oak | 1,0 | 48520-9 | 23,18 |
| Eiche rustikal, rustic oak | 2,7 | 48522-3 | 62,54 |

Holzdekorfolie/ wood decor

FUer 7-10 mm-Belaege + 2 mm Daemmung
for 7-10 mm coverings + 2 mm insulation

APL-KLICK-System 11-15 mm, 2-teilig

APL-CLICK-system 11-15 mm, 2 parts

275

APL-Klick- Höhenausgleichsprofil 11 - 15 mm, zum Klicken, Aluminium

APL-click-height levelling 11 - 15 mm, to click, aluminium

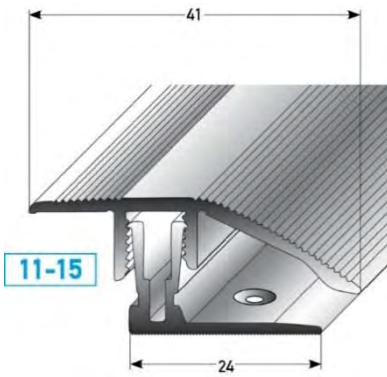

FUer 11-15 mm-Belaege + 2 mm Daemmung
for 11-15 mm coverings + 2 mm insulation

Holzdekorfolie/ wood decor

| SB-Pack incl. Schrauben + DUEbel; VE 20 Stk. | | | |
|---|-----------|-----------|-------------|
| self-service-pack with screws + dowels; à 20 pcs. | | | |
| Farbe/colour | L / l (m) | Art./ref. | €/Stk./pcs. |
| silver coloured | 0,9 | 48536-0 | 16,68 |
| silver coloured | 1,0 | 48538-4 | 18,52 |
| silver coloured | 2,7 | 48540-7 | 50,02 |
| gold coloured | 0,9 | 48542-1 | 16,70 |
| gold coloured | 1,0 | 48544-5 | 18,56 |
| gold coloured | 2,7 | 48546-9 | 50,14 |
| bronze light col. | 0,9 | 48548-3 | 17,66 |
| bronze light col. | 1,0 | 48550-6 | 19,64 |
| bronze light col. | 2,7 | 48552-0 | 53,02 |
| bronze dark col. | 0,9 | 48554-4 | 17,66 |
| bronze dark col. | 1,0 | 48556-8 | 19,64 |
| bronze dark col. | 2,7 | 48558-2 | 53,02 |
| gold hell,gold light | 0,9 | 48560-5 | 16,70 |
| gold hell,gold light | 1,0 | 48562-9 | 18,56 |
| gold hell,gold light | 2,7 | 48564-3 | 50,14 |
| edelstahlf. Stainl. steel col. | 0,9 | 48566-7 | 17,66 |
| edelstahlf. Stainl. steel col. | 1,0 | 48568-1 | 19,64 |
| edelstahlf. Stainl. steel col. | 2,7 | 48570-4 | 53,02 |
| Buche,beech | 0,9 | 48572-8 | 21,84 |
| Buche,beech | 1,0 | 48574-2 | 24,26 |
| Buche,beech | 2,7 | 48576-6 | 65,48 |
| Eiche,oak | 0,9 | 48578-0 | 21,84 |
| Eiche,oak | 1,0 | 48580-3 | 24,26 |
| Eiche,oak | 2,7 | 48582-7 | 65,48 |
| Ahorn , maple | 0,9 | 48584-1 | 21,84 |
| Ahorn , maple | 1,0 | 48586-5 | 24,26 |
| Ahorn , maple | 2,7 | 48588-9 | 65,48 |
| Kirschbaum, cherry wood | 0,9 | 48590-2 | 21,84 |
| Kirschbaum, cherry wood | 1,0 | 48592-6 | 24,26 |
| Kirschbaum, cherry wood | 2,7 | 48594-0 | 65,48 |
| Eiche rustikal, rustic oak | 0,9 | 48596-4 | 21,84 |
| Eiche rustikal, rustic oak | 1,0 | 48598-8 | 24,26 |
| Eiche rustikal, rustic oak | 2,7 | 48600-8 | 65,48 |

APL-KLICK-System 15-24 mm, 2-teilig

APL-CLICK-system 15-24 mm, 2 parts

450

APL-Klick- Höhenausgleichsprofil 15 - 24 mm, zum Klicken, Aluminium

APL-click-height levelling 15 - 24 mm, to click, aluminium

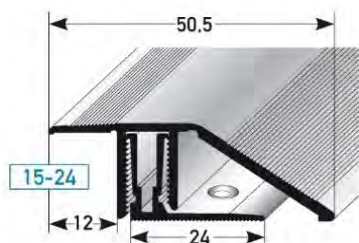

FUer 15-24 mm-Belaege + 2 mm Daemmung
for 15-24 mm coverings + 2 mm insulation

| SB-Pack incl. Schrauben + DUEbel; VE 20 Stk. | | | |
|---|-----------|-----------|-------------|
| self-service-pack with screws + dowels; à 20 pcs. | | | |
| Farbe/colour | L / l (m) | Art./ref. | €/Stk./pcs. |
| silver coloured | 0,9 | 68528-9 | 22,24 |
| silver coloured | 1,0 | 68530-2 | 24,72 |
| silver coloured | 2,7 | 68532-6 | 66,74 |
| gold coloured | 0,9 | 68534-0 | 22,28 |
| gold coloured | 1,0 | 68536-4 | 24,76 |
| gold coloured | 2,7 | 68538-8 | 66,84 |
| bronze light col. | 0,9 | 68540-1 | 23,62 |
| bronze light col. | 1,0 | 68542-5 | 26,24 |
| bronze light col. | 2,7 | 68544-9 | 70,88 |
| bronze dark col. | 0,9 | 68546-3 | 23,62 |
| bronze dark col. | 1,0 | 68548-7 | 26,24 |
| bronze dark col. | 2,7 | 68550-0 | 70,88 |
| gold hell,gold light | 0,9 | 68552-4 | 22,28 |
| gold hell,gold light | 1,0 | 68554-8 | 24,76 |
| gold hell,gold light | 2,7 | 68556-2 | 66,84 |
| edelstahlf. Stainl. steel col. | 0,9 | 68558-6 | 23,62 |
| edelstahlf. Stainl. steel col. | 1,0 | 68560-9 | 26,24 |
| edelstahlf. Stainl. steel col. | 2,7 | 68562-3 | 70,88 |

MINI-APL-KLICK-System 4-7 mm, 2-teilig

MINI-APL-CLICK-system 4-7 mm, 2 parts

451

MINI-APL-Klick-

Abschlussprofil

4 - 7 mm, zum Klicken, Aluminium

MINI-APL-click-end 4 - 7 mm, to click, aluminium

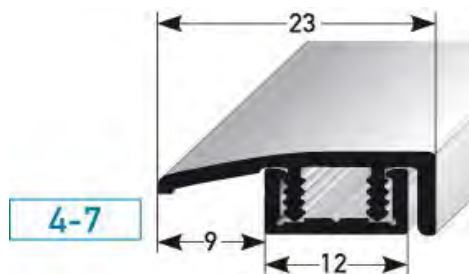

SB-Pack incl. Schrauben + DUEbel; VE 20 Stk.

self-service-pack with screws + dowels; à 20 pcs.

| Farbe/colour | L / l (m) | Art./ref. | €/Stk./pcs. |
|--------------------------------|-----------|-----------|-------------|
| silver coloured | 0,9 | 68572-2 | 12,72 |
| silver coloured | 1,0 | 68574-6 | 14,12 |
| silver coloured | 2,7 | 68576-0 | 38,12 |
| gold coloured | 0,9 | 68578-4 | 13,04 |
| gold coloured | 1,0 | 68580-7 | 14,50 |
| gold coloured | 2,7 | 68582-1 | 39,14 |
| bronze light col. | 0,9 | 68584-5 | 14,18 |
| bronze light col. | 1,0 | 68586-9 | 15,76 |
| bronze light col. | 2,7 | 68588-3 | 42,54 |
| bronze dark col. | 0,9 | 68590-6 | 14,18 |
| bronze dark col. | 1,0 | 68592-0 | 15,76 |
| bronze dark col. | 2,7 | 68594-4 | 42,54 |
| gold hell,gold light | 0,9 | 68596-8 | 13,04 |
| gold hell,gold light | 1,0 | 68598-2 | 14,50 |
| gold hell,gold light | 2,7 | 68600-2 | 39,14 |
| edelstahlf. Stainl. steel col. | 0,9 | 68602-6 | 14,18 |
| edelstahlf. Stainl. steel col. | 1,0 | 68604-0 | 15,76 |
| edelstahlf. Stainl. steel col. | 2,7 | 68606-4 | 42,54 |

APL-KLICK-System 7-10 mm, 2-teilig

APL-CLICK-system 7-10 mm, 2 parts

276

APL-Klick-

Abschlussprofil

7 - 10 mm, zum Klicken, Aluminium

APL-click-end 7 - 10 mm, to click, aluminium

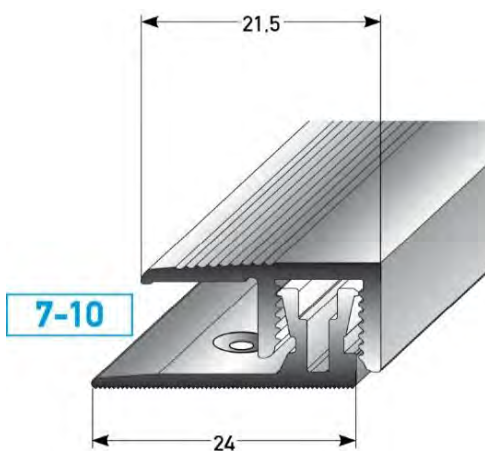

SB-Pack incl. Schrauben + DUEbel; VE 20 Stk.

self-service-pack with screws + dowels; à 20 pcs.

| Farbe/colour | L / l (m) | Art./ref. | €/Stk./pcs. |
|--------------------------------|-----------|-----------|-------------|
| silver coloured | 0,9 | 48616-9 | 12,60 |
| silver coloured | 1,0 | 48618-3 | 14,02 |
| silver coloured | 2,7 | 48620-6 | 37,82 |
| gold coloured | 0,9 | 48622-0 | 12,72 |
| gold coloured | 1,0 | 48624-4 | 14,10 |
| gold coloured | 2,7 | 48626-8 | 38,10 |
| bronze light col. | 0,9 | 48628-2 | 13,46 |
| bronze light col. | 1,0 | 48630-5 | 14,96 |
| bronze light col. | 2,7 | 48632-9 | 40,40 |
| bronze dark col. | 0,9 | 48634-3 | 13,46 |
| bronze dark col. | 1,0 | 48636-7 | 14,96 |
| bronze dark col. | 2,7 | 48638-1 | 40,40 |
| gold hell,gold light | 0,9 | 48640-4 | 12,72 |
| gold hell,gold light | 1,0 | 48642-8 | 14,10 |
| gold hell,gold light | 2,7 | 48644-2 | 38,10 |
| edelstahlf. Stainl. steel col. | 0,9 | 48646-6 | 13,46 |
| edelstahlf. Stainl. steel col. | 1,0 | 48648-0 | 14,96 |
| edelstahlf. Stainl. steel col. | 2,7 | 48650-3 | 40,40 |
| Buche,beech | 0,9 | 48652-7 | 17,66 |
| Buche,beech | 1,0 | 48654-1 | 19,64 |
| Buche,beech | 2,7 | 48656-5 | 53,02 |
| Eiche,oak | 0,9 | 48658-9 | 17,66 |
| Eiche,oak | 1,0 | 48660-2 | 19,64 |
| Eiche,oak | 2,7 | 48662-6 | 53,02 |
| Ahorn , maple | 0,9 | 48664-0 | 17,66 |
| Ahorn , maple | 1,0 | 48666-4 | 19,64 |
| Ahorn , maple | 2,7 | 48668-8 | 53,02 |
| Kirschbaum, cherry wood | 0,9 | 48670-1 | 17,66 |
| Kirschbaum, cherry wood | 1,0 | 48672-5 | 19,64 |
| Kirschbaum, cherry wood | 2,7 | 48674-9 | 53,02 |
| Eiche rustikal, rustic oak | 0,9 | 48676-3 | 17,66 |
| Eiche rustikal, rustic oak | 1,0 | 48678-7 | 19,64 |
| Eiche rustikal, rustic oak | 2,7 | 48680-0 | 53,02 |

FUer 7-10 mm-Belaege + 2 mm Daemmung
for 7-10 mm coverings + 2 mm insulation

Holzdekorfolie/ wood decor

APL-KLICK-System 11-15 mm, 2-teilig

APL-CLICK-system 11-15 mm, 2 parts

277

APL-Klick-Abschlussprofil

**11 - 15 mm, zum Klicken,
Aluminium**

APL-click-end 11 - 15 mm, to click, aluminium

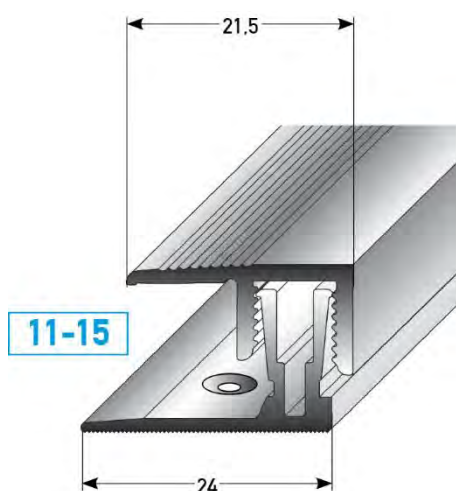

FUer 11-15 mm-Belaege + 2 mm
Daemmung for 11-15 mm
coverings + 2 mm insulation

SB-Pack incl. Schrauben + DUEbel; VE 20 Stk.

self-service-pack with screws + dowels; à 20 pcs.

| Farbe/colour | L / l (m) | Art./ref. | €/Stk./pcs. |
|--------------------------------|-----------|-----------|-------------|
| silver coloured | 0.9 | 48694-7 | 13,50 |
| silver coloured | 1.0 | 48696-1 | 14,98 |
| silver coloured | 2.7 | 48698-5 | 40,44 |
| gold coloured | 0.9 | 48700-5 | 13,58 |
| gold coloured | 1.0 | 48702-9 | 15,10 |
| gold coloured | 2.7 | 48704-3 | 40,72 |
| bronze light col. | 0.9 | 48706-7 | 14,32 |
| bronze light col. | 1.0 | 48708-1 | 15,92 |
| bronze light col. | 2.7 | 48710-4 | 43,00 |
| bronze dark col. | 0.9 | 48712-8 | 14,32 |
| bronze dark col. | 1.0 | 48714-2 | 15,92 |
| bronze dark col. | 2.7 | 48716-6 | 43,00 |
| gold hell,gold light | 0.9 | 48718-0 | 13,58 |
| gold hell,gold light | 1.0 | 48720-3 | 15,10 |
| gold hell,gold light | 2.7 | 48722-7 | 40,72 |
| edelstahlf. Stainl. steel col. | 0.9 | 48724-1 | 14,32 |
| edelstahlf. Stainl. steel col. | 1.0 | 48726-5 | 15,92 |
| edelstahlf. Stainl. steel col. | 2.7 | 48728-9 | 43,00 |
| Buche,beech | 0.9 | 48730-2 | 18,54 |
| Buche,beech | 1.0 | 48732-6 | 20,62 |
| Buche,beech | 2.7 | 48734-0 | 55,64 |
| Eiche,oak | 0.9 | 48736-4 | 18,54 |
| Eiche,oak | 1.0 | 48738-8 | 20,62 |
| Eiche,oak | 2.7 | 48740-1 | 55,64 |
| Ahorn , maple | 0.9 | 48742-5 | 18,54 |
| Ahorn , maple | 1.0 | 48744-9 | 20,62 |
| Ahorn , maple | 2.7 | 48746-3 | 55,64 |
| Kirschbaum, cherry wood | 0.9 | 48748-7 | 18,54 |
| Kirschbaum, cherry wood | 1.0 | 48750-0 | 20,62 |
| Kirschbaum, cherry wood | 2.7 | 48752-4 | 55,64 |
| Eiche rustikal, rustic oak | 0.9 | 48754-8 | 18,54 |
| Eiche rustikal, rustic oak | 1.0 | 48756-2 | 20,62 |
| Eiche rustikal, rustic oak | 2.7 | 48758-6 | 55,64 |

Holzdekorfolie/ wood decor

SKD - SYSTEM FUER KLICKDESIGN-BELAEAGE 4 - 7 mm, flexibel, 2-teilig

SKD - system for click design flooring 4-7 mm, flexible, 2 parts

315

SB-Pack incl. Schrauben + DUEbel; VE 20 Stk.

self-service-pack with screws + dowels; à 20 pcs.

| Farbe/colour | L / l (m) | Art./ref. | €/Stk./pcs. |
|--------------|-----------|-----------|-------------|
|--------------|-----------|-----------|-------------|

SKD-Uebergangprofil fUer Klickdesign-Belaege fUer Höhe 4 - 7 mm, flexibel, Alu., gebohrt

SKD-edge for click design flooring
4 - 7 mm, flexible, aluminium, drilled

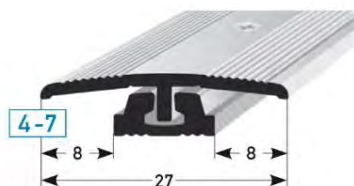

316 **Schrauben siehe Abschnitt 12.**
Extra screws, see section 12.

| | | | |
|--------------------------------|---------------------|-------------------------|-----------------------|
| silver coloured | 0,9 | 49014-2 | 19,50 |
| silver coloured | 2,7 | 49016-6 | 47,08 |
| gold coloured | 0,9 | 49018-0 | 20,14 |
| gold coloured | 2,7 | 49020-3 | 49,28 |
| bronze light col. | 0,9 | 49064-7 | 20,52 |
| bronze light col. | 2,7 | 49066-1 | 50,70 |
| gold hell,gold light | 0,9 | 49022-7 | 20,14 |
| gold hell,gold light | 2,7 | 49024-1 | 49,28 |
| edelstahlf. Stainl. steel col. | 0,9 | 49026-5 | 20,52 |
| edelstahlf. Stainl. steel col. | 2,7 | 49028-9 | 50,70 |

SKD-Höhenausgleichsprofil f. Klickdesign-Belaege f. Höhe 4 - 7 mm, flexibel, Alu., gebohrt

SKD-height levelling for click design flooring
4 - 7 mm, flexible, aluminium, drilled



317 **Schrauben siehe Abschnitt 12.**
Extra screws, see section 12.

| | | | |
|--------------------------------|---------------------|-------------------------|-----------------------|
| silver coloured | 0,9 | 49030-2 | 20,52 |
| silver coloured | 2,7 | 49032-6 | 50,50 |
| gold coloured | 0,9 | 49034-0 | 21,32 |
| gold coloured | 2,7 | 49036-4 | 53,10 |
| bronze light col. | 0,9 | 49068-5 | 21,74 |
| bronze light col. | 2,7 | 49070-8 | 54,92 |
| gold hell,gold light | 0,9 | 49038-8 | 21,32 |
| gold hell,gold light | 2,7 | 49040-1 | 53,10 |
| edelstahlf. Stainl. steel col. | 0,9 | 49042-5 | 21,74 |
| edelstahlf. Stainl. steel col. | 2,7 | 49044-9 | 54,92 |

SKD-Abschlussprofil fUer Klickdesign-Belaege fUer Höhe 4 - 7 mm, flexibel, Alu., gebohrt

SKD-end for click design flooring
4 - 7 mm, flexible, aluminium, drilled

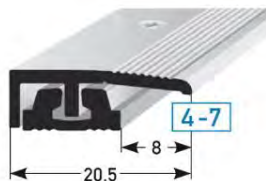

327 **Schrauben siehe Abschnitt 12.**
Extra screws, see section 12.

| | | | |
|--------------------------------|---------------------|-------------------------|-----------------------|
| silver coloured | 0,9 | 49046-3 | 19,20 |
| silver coloured | 2,7 | 49048-7 | 45,96 |
| gold coloured | 0,9 | 49050-0 | 19,72 |
| gold coloured | 2,7 | 49052-4 | 47,98 |
| bronze light col. | 0,9 | 49072-2 | 20,14 |
| bronze light col. | 2,7 | 49074-6 | 49,34 |
| gold hell,gold light | 0,9 | 49054-8 | 19,72 |
| gold hell,gold light | 2,7 | 49056-2 | 47,98 |
| edelstahlf. Stainl. steel col. | 0,9 | 49058-6 | 20,14 |
| edelstahlf. Stainl. steel col. | 2,7 | 49060-9 | 49,34 |

SKD-Lifter 4 mm fUer Profilerhöhung auf 8 - 11 mm, PVC, gebohrt

SKD-lifter 4 mm,
for increase to 8 - 11 mm,
PVC, drilled

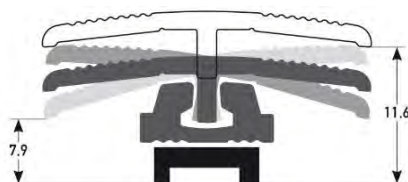
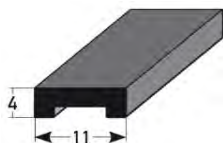

| | | |
|---------------------|-------------------------|-----------------------|
| 2,7 | 49062-3 | 22,44 |
|---------------------|-------------------------|-----------------------|

SKD - SYSTEM FUER KLICKDESIGN-BELaeGE 4 - 7 mm, flexibel, 2-teilig

SKD - system for click design flooring 4-7 mm, flexible, 2 parts

351

SB-Pack incl. Schrauben + DUEbel; VE 20 Stk.

self-service-pack with screws + dowels; à 20 pcs.

| Farbe/colour | L / l (m) | Art./ref. | €/Stk./pcs. |
|--------------|-----------|-----------|-------------|
|--------------|-----------|-----------|-------------|

SKD-Treppenkante fUer Klickdesign-Belaege fUer Höhe 4 - 7 mm, flexibel, Alu., gebohrt

SKD-stair nosing for click design flooring
4 - 7 mm, flexible, aluminium, drilled

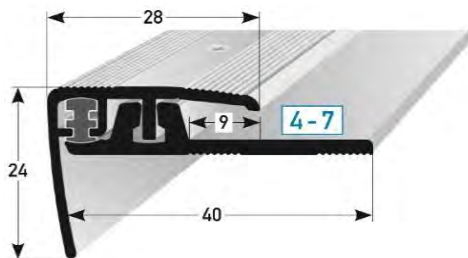

| | | | |
|--------------------------------|---------------------|-------------------------|-----------------------|
| silver coloured | 0,9 | 49078-4 | 31,36 |
| silver coloured | 2,7 | 49088-3 | 84,68 |
| gold coloured | 0,9 | 49080-7 | 32,52 |
| gold coloured | 2,7 | 49090-6 | 87,84 |
| bronze light col. | 0,9 | 49086-9 | 33,34 |
| bronze light col. | 2,7 | 49096-8 | 90,02 |
| gold hell,gold light | 0,9 | 49082-1 | 32,52 |
| gold hell,gold light | 2,7 | 49092-0 | 87,84 |
| edelstahlf. Stainl. steel col. | 0,9 | 49084-5 | 33,34 |
| edelstahlf. Stainl. steel col. | 2,7 | 49094-4 | 90,02 |

Extra Schrauben siehe Abschnitt 12.
Extra screws, see section 12.

SKD - System fUer Klickdesign-Belaege

SKD - system for click design flooring

SLP-System 7-17 mm, FLEX, 3-teilig

SLP-system 7-17 mm, flexible, 3 parts

138

SLP-Uebergangsprofil 35 mm fuer Laminat/ Parkett 7 - 17 mm flexibel, 3-teilig, Aluminium, gebohrt

SLP-edge 35 mm for laminate/ wooden floors,
7 - 17 mm, flexible 3 parts, aluminium, drilled

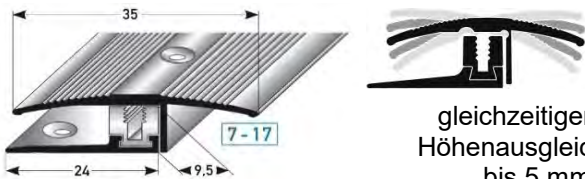

gleichzeitiger
Höhenausgleich
bis 5 mm
height levelling up to 5 mm

Grundprofilerrhöhung +8 mm,
siehe Seite 80

higher basic profile +8 mm, see page 80

139 Schrauben siehe Abschnitt 12.

Extra screws, see section 12.

| SB-Pack incl. Schrauben + DUEbel; VE 20 Stk. | | | |
|---|-----------|-----------|-------------|
| self-service-pack with screws + dowels; à 20 pcs. | | | |
| Farbe/colour | L / l (m) | Art./ref. | €/Stk./pcs. |
| silver coloured | 0,9 | 42005-7 | 16,80 |
| silver coloured | 2,7 | 42000-2 | 50,38 |
| gold coloured | 0,9 | 42015-6 | 17,10 |
| gold coloured | 2,7 | 42010-1 | 51,38 |
| bronze light col. | 0,9 | 42025-5 | 19,68 |
| bronze light col. | 2,7 | 42020-0 | 58,98 |
| gold hell,gold light | 0,9 | 62020-4 | 17,10 |
| gold hell,gold light | 2,7 | 62025-9 | 51,38 |
| Holzdekorfolie/ wood decor | | | |
| Buche,beech | 0,9 | 42045-3 | 22,58 |
| Buche,beech | 2,7 | 42040-8 | 67,80 |
| Eiche,oak | 0,9 | 42055-2 | 22,58 |
| Eiche,oak | 2,7 | 42050-7 | 67,80 |
| Ahorn , maple | 0,9 | 42065-1 | 22,58 |
| Ahorn , maple | 2,7 | 42060-6 | 67,80 |
| Kirschenbaum, cherry | 0,9 | 43254-8 | 22,58 |
| Kirschenbaum, cherry | 2,7 | 43256-2 | 67,80 |
| Eiche rustikal, rustic | 0,9 | 43258-6 | 22,58 |
| Eiche rustikal, rustic | 2,7 | 43260-9 | 67,80 |

SLP-Höhenausgleichsprofil 39 mm fuer Laminat/ Parkett 7 - 17 mm flexibel, 3-teilig, Aluminium, gebohrt

SLP-height levelling 39 mm for laminate/ wooden floors, 7
17 mm, flexible, 3 parts, aluminium, drilled

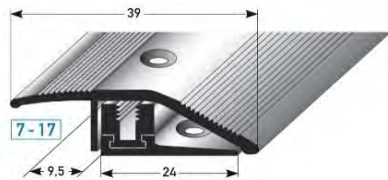

Extra
Schrauben
siehe
Abschnitt 12.
Extra screws,
see section 12.

Grundprofilerrhöhung +8 mm,
siehe Seite 80

140 higher basic profile +8 mm, see page 80

| | | | |
|----------------------------|-----|---------|-------|
| silver coloured | 0,9 | 42075-0 | 18,72 |
| silver coloured | 2,7 | 42070-5 | 56,06 |
| gold coloured | 0,9 | 42085-9 | 19,02 |
| gold coloured | 2,7 | 42080-4 | 57,08 |
| bronze light col. | 0,9 | 42095-8 | 21,82 |
| bronze light col. | 2,7 | 42090-3 | 65,42 |
| gold hell,gold light | 0,9 | 62040-2 | 19,02 |
| gold hell,gold light | 2,7 | 62045-7 | 57,08 |
| Holzdekorfolie/ wood decor | | | |
| Buche,beech | 0,9 | 42115-3 | 23,82 |
| Buche,beech | 2,7 | 42110-8 | 71,46 |
| Eiche,oak | 0,9 | 42125-2 | 23,82 |
| Eiche,oak | 2,7 | 42120-7 | 71,46 |
| Ahorn , maple | 0,9 | 42135-1 | 23,82 |
| Ahorn , maple | 2,7 | 42130-6 | 71,46 |
| Kirschenbaum, cherry | 0,9 | 43264-7 | 23,82 |
| Kirschenbaum, cherry | 2,7 | 43266-1 | 71,46 |
| Eiche rustikal, rustic | 0,9 | 43268-5 | 23,82 |
| Eiche rustikal, rustic | 2,7 | 43270-8 | 71,46 |

SLP-Abschlussprofil 24 mm fuer Laminat/ Parkett 7 - 17 mm flexibel, 3-teilig, Aluminium, gebohrt

SLP-end 24 mm for laminate/ wooden floors
7 - 17 mm, flexible, 3 parts, aluminium, drilled

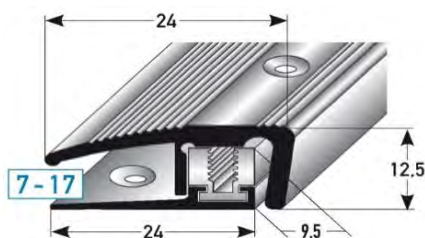

Extra Schrauben siehe Abschnitt 12.

Extra screws, see section 12.

| | | | |
|----------------------------|-----|---------|-------|
| silver coloured | 0,9 | 42145-0 | 15,22 |
| silver coloured | 2,7 | 42140-5 | 45,64 |
| gold coloured | 0,9 | 42155-9 | 15,56 |
| gold coloured | 2,7 | 42150-4 | 46,68 |
| bronze light col. | 0,9 | 42165-8 | 18,08 |
| bronze light col. | 2,7 | 42160-3 | 54,26 |
| gold hell,gold light | 0,9 | 62060-0 | 15,56 |
| gold hell,gold light | 2,7 | 62065-5 | 46,68 |
| Holzdekorfolie/ wood decor | | | |
| Buche,beech | 0,9 | 42185-6 | 21,52 |
| Buche,beech | 2,7 | 42180-1 | 64,62 |
| Eiche,oak | 0,9 | 42195-5 | 21,52 |
| Eiche,oak | 2,7 | 42190-0 | 64,62 |
| Ahorn , maple | 0,9 | 42205-1 | 21,52 |
| Ahorn , maple | 2,7 | 42200-6 | 64,62 |
| Kirschenbaum, cherry | 0,9 | 43274-6 | 21,52 |
| Kirschenbaum, cherry | 2,7 | 43276-0 | 64,62 |
| Eiche rustikal, rustic | 0,9 | 43278-4 | 21,52 |
| Eiche rustikal, rustic | 2,7 | 43280-7 | 64,62 |

SLP-Treppenkante 7-15,5 mm, FLEX, 3-teilig

SLP-stair nosing 7-15,5 mm, flexible, 3 parts

| | | | |
|-----|---|-----------|-----------|
| 141 | SB-Pack incl. Schrauben + DUEbel; VE 20 Stk. | | |
| | self-service-pack with screws + dowels; à 20 pcs. | | |
| | Farbe/colour | L / l (m) | Art./ref. |

SLP-Treppenkante 28 mm, fUer Laminat/ Parkett 7 - 15,5 mm, flexibel, 3-teilig, Alu., gebohrt

SLP-stair nosing 28 mm, for laminate/ wooden floors
7 - 15,5 mm, flexible, 3 parts, aluminium, drilled

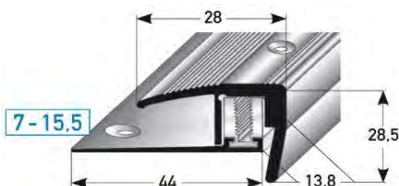

Extra Schrauben siehe Abschnitt 12./
Extra screws, see section 12.

| | | | |
|----------------------|-----|---------|--------|
| silver coloured | 0.9 | 41880-1 | 30.84 |
| silver coloured | 2.7 | 41890-0 | 92.54 |
| gold coloured | 0.9 | 41900-6 | 31.26 |
| gold coloured | 2.7 | 41910-5 | 93.74 |
| bronze light col. | 0.9 | 41920-4 | 35.22 |
| bronze light col. | 2.7 | 41930-3 | 105.68 |
| gold hell,gold light | 0.9 | 62000-6 | 31.26 |
| gold hell,gold light | 2.7 | 62005-1 | 93.74 |

SLP-System fUer Parkett 12-22 mm, FLEX, 3-teilig

SLP-system for wooden floors 12-22 mm, flexible, 3 parts

SLP-Uebergangspr. 12-22mm flex. Alu

SLP-Uebergangspr. 35 mm, fUer Parkett 12 - 22 mm, flexibel, 3-teilig, Aluminium, gebohrt

SLP-edge 35 mm for wooden floors
12 - 22 mm, flexible, 3 parts, aluminium, drilled

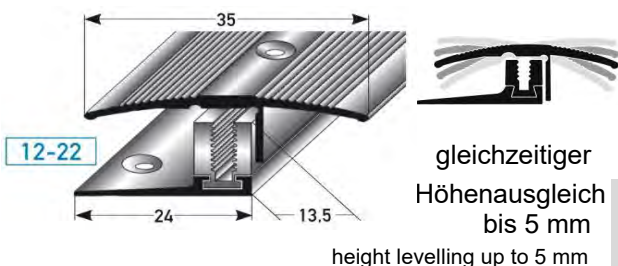

gleichzeitiger Höhengleich bis 5 mm
height levelling up to 5 mm

Grundprofilerhöhung +8 mm, siehe Seite 80
higher basic profile +8 mm, see page 80

153 Extra Schrauben siehe Abschnitt 12.
Extra screws, see section 12.

| | | | |
|----------------------------|-----|---------|-------|
| silver coloured | 0.9 | 43000-1 | 21.66 |
| silver coloured | 2.7 | 43002-5 | 61.16 |
| gold coloured | 0.9 | 43004-9 | 22.02 |
| gold coloured | 2.7 | 43006-3 | 62.34 |
| bronze light col. | 0.9 | 43008-7 | 25.02 |
| bronze light col. | 2.7 | 43010-0 | 71.26 |
| gold hell,gold light | 0.9 | 43012-4 | 22.02 |
| gold hell,gold light | 2.7 | 43014-8 | 62.34 |
| Buche,beech | 0.9 | 43016-2 | 28.44 |
| Buche,beech | 2.7 | 43018-6 | 81.66 |
| Eiche,oak | 0.9 | 43020-9 | 28.44 |
| Eiche,oak | 2.7 | 43022-3 | 81.66 |
| Ahorn , maple | 0.9 | 43024-7 | 28.44 |
| Ahorn , maple | 2.7 | 43026-1 | 81.66 |
| Kirschbaum, cherry wood | 0.9 | 43028-5 | 28.44 |
| Kirschbaum, cherry wood | 2.7 | 43030-8 | 81.66 |
| Eiche rustikal, rustic oak | 0.9 | 43032-2 | 28.44 |
| Eiche rustikal, rustic oak | 2.7 | 43034-6 | 81.66 |

SLP-Anpassungspr. 12-22 mm flex. Alu

SLP-Höhenausgleichspr. 50 mm, f. Parkett 12 - 22 mm, flexibel, 3-teilig, Alu., gebohrt

SLP-height levelling 50 mm for wooden floors
12 - 22 mm, flexible, 3 parts, aluminium, drilled

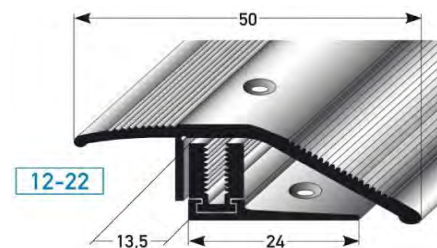

Grundprofilerhöhung +8 mm, siehe Seite 80
higher basic profile +8 mm, see page 80

Extra Schrauben siehe Abschnitt 12.
Extra screws, see section 12.

| | | | |
|----------------------------|-----|---------|--------|
| silver coloured | 0.9 | 43046-9 | 27.40 |
| silver coloured | 2.7 | 43048-3 | 82.06 |
| gold coloured | 0.9 | 43050-6 | 27.86 |
| gold coloured | 2.7 | 43052-0 | 83.56 |
| bronze light col. | 0.9 | 43054-4 | 32.06 |
| bronze light col. | 2.7 | 43056-8 | 96.16 |
| gold hell,gold light | 0.9 | 43058-2 | 27.86 |
| gold hell,gold light | 2.7 | 43060-5 | 83.56 |
| Buche,beech | 0.9 | 43062-9 | 35.10 |
| Buche,beech | 2.7 | 43064-3 | 105.24 |
| Eiche,oak | 0.9 | 43066-7 | 35.10 |
| Eiche,oak | 2.7 | 43068-1 | 105.24 |
| Ahorn , maple | 0.9 | 43070-4 | 35.10 |
| Ahorn , maple | 2.7 | 43072-8 | 105.24 |
| Kirschbaum, cherry wood | 0.9 | 43074-2 | 35.10 |
| Kirschbaum, cherry wood | 2.7 | 43076-6 | 105.24 |
| Eiche rustikal, rustic oak | 0.9 | 43078-0 | 35.10 |
| Eiche rustikal, rustic oak | 2.7 | 43080-3 | 105.24 |

SLP-System 7-17 mm, Edelstahl matt, FLEX, fUer Laminat/ Parkett

SLP-system 7-17 mm, stainless steel satin, flexible, for laminate/ wooden floors

SLP-Uebergangspr. Edelstahl 7-17mm flex

151

SB-Pack incl. Schrauben + DUEbel; VE 20 Stk.

self-service-pack with screws + dowels; à 20 pcs.

| Dimension in mm | L / l (m) | Art./ref. | €/Stk./pcs. |
|-----------------|-----------|-----------|-------------|
|-----------------|-----------|-----------|-------------|

SLP-Uebergangsprofil 37 mm, Edelstahl matt, fUer 7 - 17 mm, flexibel, 3-teilig, gebohrt

SLP-edge 37 mm, stainless steel satin, for 7 - 17 mm, flexible, 3 parts, drilled

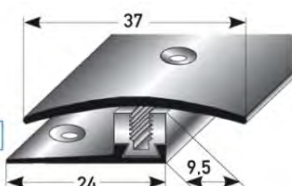

7-17



gleichzeitig Höhengleichung bis 5 mm
height levelling up to 5 mm

Extra Schrauben siehe Abschnitt 12.

Extra screws, see section 12.

| | | | |
|-------------|-----|---------|-------|
| 37 x 1,5 mm | 0,9 | 42900-5 | 25,18 |
| 37 x 1,5 mm | 2,7 | 42905-0 | 75,48 |

SLP Anpassungspr. Edelstahl 7-17mm

SLP-Höhenausgleichsprofil 42 mm, Edelstahl matt, fUer 7 - 17 mm, flex, 3-teilig, gebohrt

SLP-height levelling 42 mm, stainless steel satin, for 7 - 17 mm, flexible, 3 parts, drilled

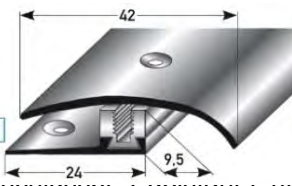

7-17

| | | | |
|-------------|-----|---------|-------|
| 42 x 1,5 mm | 0,9 | 42910-4 | 26,42 |
| 42 x 1,5 mm | 2,7 | 42915-9 | 79,22 |

Extra Schrauben siehe Abschnitt 12.

Extra screws, see section 12.

SLP Anpassungspr. Edelstahl 7-17mm

SLP-Abschlussprofil 30 mm, Edelstahl matt, f. Gesamthöhe 7 - 9 mm, flex., 3-teilig, gebohrt

SLP-end 30 mm, stainless steel satin, for heights 7 - 9 mm, flexible, 3 parts, drilled

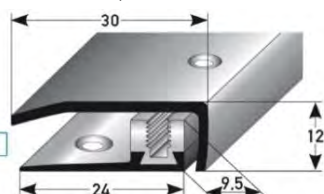

7-9

| | | | |
|-------------------|-----|---------|-------|
| 7-9 x 30 x 1,5 mm | 0,9 | 42920-3 | 25,18 |
| 7-9 x 30 x 1,5 mm | 2,7 | 42925-8 | 75,48 |

Extra Schrauben siehe Abschnitt 12.

Extra screws, see section 12.

SLP Abschlusspr. Edelstahl 10-13mm

SLP-Abschlussprof. 25 mm, Edelst. matt, f. Gesamthöhe 10 - 13 mm, flex., 3-teilig, gebohrt

SLP-end 25 mm, stainless steel satin, for heights 10 - 13 mm, flexible, 3 parts, drilled

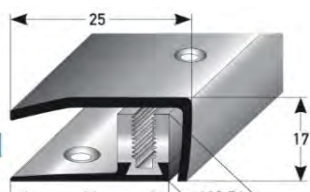

10-13

| | | | |
|---------------------|-----|---------|-------|
| 10-13 x 25 x 1,5 mm | 0,9 | 42930-2 | 26,42 |
| 10-13 x 25 x 1,5 mm | 2,7 | 42935-7 | 79,22 |

Extra Schrauben siehe Abschnitt 12.

Extra screws, see section 12.

SLP Abschlusspr. Edelstahl 14-17mm

SLP-Abschlussprof. 23 mm, Edelst. matt, f. Gesamthöhe 14 - 17 mm, flex., 3-teilig, gebohrt

SLP-end 23 mm, stainless steel satin, for heights 14 - 17 mm, flexible, 3 parts, drilled

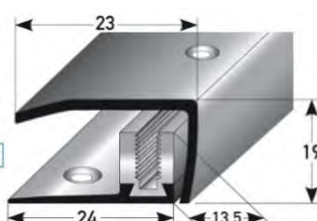

14-17

| | | | |
|---------------------|-----|---------|-------|
| 14-17 x 23 x 1,5 mm | 0,9 | 42940-1 | 26,42 |
| 14-17 x 23 x 1,5 mm | 2,7 | 42945-6 | 79,22 |

Extra Schrauben siehe Abschnitt 12.

Extra screws, see section 12.

9. FLIESENTRENN-, DEHNUNGSFUGEN-, BAU- & T-PROFILE AUS ALUMINIUM, EDELSTAHL, MESSING & PVC

9. CERAMIC TILE SEPARATION, EXPANSION GAP,
BUILDING + T-PROFILES OUT OF ALUMINIUM,
STAINLESS STEEL, BRASS + PVC

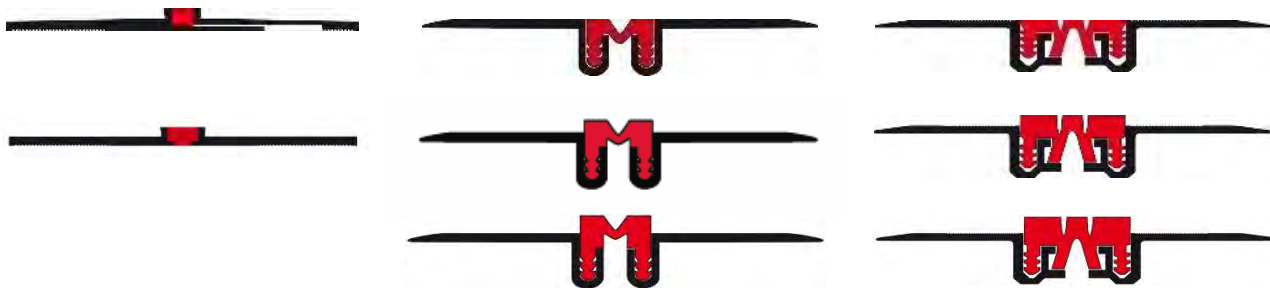

9. FLIESENTRENN-, DEHNUNGSFUGEN-, BAU- & T-PROFILE / 9. CERAMIC TILE SEPARATION, EXPANSION GAP, BUILDING + T-PROFILES

Fliesentrennprofil

ceramic tile
profile

separation

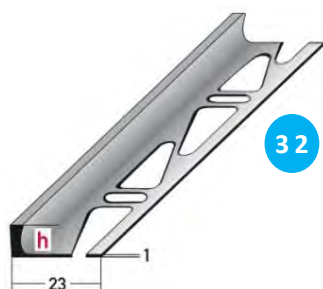

| Fliesentrennprofil nach Innenmaß | | | | | |
|--|-----------|-------------------------|-----------------------|-------------------------|-----------------------|
| ceramic tile separation profile with inside measures | | | | | |
| Material/material | L / l (m) | Stk./VE / pcs/unit | Höhe/ height (mm) | Art./ref. | €/Stueck |
| Aluminium pressblank aluminium mill-finish | 2,5 | 10 | 2 mm | 30129-5 | 7.70 |
| | 2,5 | | 3 mm | 30135-6 | 7.70 |
| | 2,5 | | 3 mm | 30130-1 | 7.70 |
| | 2,5 | | 5 mm | 30140-0 | 7.70 |
| | 2,5 | | 6 mm | 30150-9 | 7.76 |
| | 2,5 | | 8 mm | 30160-8 | 8.64 |
| | 2,5 | | 10 mm | 30170-7 | 9.60 |
| | 2,5 | | 11 mm | 30175-2 | 10.22 |
| | 2,5 | | 13 mm | 30180-6 | 10.66 |
| | 2,5 | | 15 mm | 30190-5 | 12.00 |
| | 2,5 | | 18 mm | 30766-2 | 15.38 |
| | 2,5 | | 20 mm | 30767-9 | 19.24 |
| | 2,5 | | 22 mm | 30195-0 | 19.50 |
| | 2,5 | | 25 mm | 30768-6 | 20.66 |
| 2,5 | 30 mm | 30769-3 | 21.80 | | |

| | | | | | |
|--|-----|----|------|-------------------------|-----------------------|
| Aluminium silber eloxiert aluminium silver anodized | 2,5 | 10 | 2 mm | 69582-0 | 11,82 |
| | | | 3 mm | 69584-4 | 11,82 |
| | | | 3 mm | 69586-8 | 11,82 |
| | | | 5 mm | 69588-2 | 11,82 |
| | | | 6 mm | 69590-5 | 11,92 |

| | | | | | |
|---|-----|----|------|-------------------------|-----------------------|
| Aluminium schwarz elox. aluminium black anodized | 2,5 | 10 | 2 mm | 69594-3 | 13,12 |
| | | | 3 mm | 69596-7 | 13,12 |
| | | | 3 mm | 69598-1 | 13,12 |
| | | | 5 mm | 69600-1 | 13,12 |
| | | | 6 mm | 69602-5 | 13,38 |

Andere Größen oder Eloxalfarben auf Anfrage möglich - Lieferzeit ca. 14 Tage
other sizes or anodized colours available on request - delivery time 14 days

9. FLIESENTRENN-, DEHNUNGSFUGEN-, BAU- & T-PROFILE/ 9. CERAMIC TILE SEPARATION, EXPANSION GAP, BUILDING + T-PROFILES

Fliesentrennprofil

ceramic tile
profile

34 separation

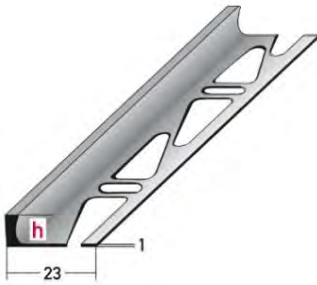

33

36

Fliesentrennprofil nach Innenmaß

ceramic tile separation profile with inside measures

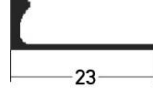
| Material/material | L / l (m) | Stk./VE / pcs/unit | Höhe/ height (mm) | Art./ref. | €/StUeck/pcs |
|---|-----------|-----------------------|----------------------|-------------------------|-----------------------|
| Messing pressblank brass mill-finish  | 2,5 | 10 | 3 mm | 30010-6 | 26,48 |
| | 2,5 | | 5 mm | 30020-5 | 26,66 |
| | 2,5 | | 6 mm | 30030-4 | 27,72 |
| | 2,5 | | 8 mm | 30040-3 | 29,14 |
| | 2,5 | | 10 mm | 30050-2 | 31,50 |
| | 2,5 | | 13 mm | 30060-1 | 35,50 |
| | 2,5 | | 15 mm | 30070-0 | 37,74 |
| | 2,5 | | 22 mm | 30075-5 | 51,58 |

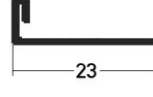
| | | | | | |
|--|-----|----|-------|-------------------------|-----------------------|
| Edelstahl stainless steel  | 2,5 | 10 | 2 mm | 30072-4 | 20,86 |
| | 2,5 | | 3 mm | 30765-5 | 20,86 |
| | 2,5 | | 3 mm | 30073-1 | 20,86 |
| | 2,5 | | 5 mm | 30074-8 | 21,46 |
| | 2,5 | | 6 mm | 30080-9 | 22,84 |
| | 2,5 | | 8 mm | 30090-8 | 23,54 |
| | 2,5 | | 10 mm | 30100-4 | 24,42 |
| | 2,5 | | 11 mm | 30105-9 | 25,60 |
| | 2,5 | | 13 mm | 30110-3 | 26,14 |
| | 2,5 | | 15 mm | 30120-2 | 26,96 |
| | 2,5 | | 17 mm | 30123-3 | 27,80 |
| | 2,5 | | 20 mm | 30762-4 | 28,62 |
| | 2,5 | | 22 mm | 30125-7 | 29,16 |
| | 2,5 | | 25 mm | 30763-1 | 31,92 |
| | 2,5 | | 30 mm | 30764-8 | 35,78 |

| | | | | | |
|-------------------------------|-----|----|-------|-------------------------|----------------------|
| PVC weiß PVC white | 2,5 | 10 | 6 mm | 30340-4 | 7,82 |
| | 2,5 | | 8 mm | 30350-3 | 8,68 |
| | 2,5 | | 10 mm | 30360-2 | 9,40 |
| PVC beige PVC beige | 2,5 | | 6 mm | 30370-1 | 7,82 |
| | 2,5 | | 8 mm | 30380-0 | 8,68 |
| | 2,5 | | 10 mm | 30390-9 | 9,40 |
| PVC grau PVC grey | 2,5 | | 6 mm | 30400-5 | 7,82 |
| | 2,5 | | 8 mm | 30410-4 | 8,68 |
| | 2,5 | | 10 mm | 30420-3 | 9,40 |

9. FLIESENTRENN-, DEHNUNGSFUGEN-, BAU- & T-PROFILE/ 9. CERAMIC TILE SEPARATION, EXPANSION GAP, BUILDING + T-PROFILES

Flexibles Fliesentrennprofil nach Innenmaß

flexible ceramic tile separation profile with inside measures

| Material/ material | L / l (m) | Stk./VE / pcs/unit | Höhe/ height (mm) | Art./ref. | €/StUeck/ pcs. |
|--|-----------|--------------------|-------------------|-------------------------|-----------------------|
| Aluminium pressblank aluminium mill-finish | 2,5 | 10 | 2 mm | 30268-1 | 14,22 |
| | 2,5 | | 3 mm | 30270-4 | 12,76 |
| | 2,5 | | 5 mm | 30280-3 | 12,92 |
| | 2,5 | | 6 mm | 30290-2 | 13,18 |
| | 2,5 | | 8 mm | 30300-8 | 13,58 |
| | 2,5 | | 10 mm | 30310-7 | 14,24 |
| | 2,5 | | 13 mm | 30320-6 | 15,08 |
| | 2,5 | | 15 mm | 30330-5 | 16,14 |
| | 2,5 | | 18 mm | 69606-3 | 19,82 |
| | 2,5 | | 20 mm | 69608-7 | 20,78 |
| | 2,5 | | 22 mm | 30335-0 | 21,36 |
| | 2,5 | | 25 mm | 69612-4 | 24,66 |
| | 2,5 | | 30 mm | 69614-8 | 27,02 |

Flexibles Fliesentrennprofil

flexible ceramic tile separation profile



Schlueterschiene flexibel Messing blank

165

| | | | | | |
|--|-----|----|-------|-------------------------|-----------------------|
| Messing pressblank brass mill-finish | 2,5 | 10 | 3 mm | 30200-1 | 32,04 |
| | 2,5 | | 5 mm | 30210-0 | 32,50 |
| | 2,5 | | 6 mm | 30220-9 | 34,00 |
| | 2,5 | | 8 mm | 30230-8 | 36,00 |
| | 2,5 | | 10 mm | 30240-7 | 38,28 |
| | 2,5 | | 13 mm | 30250-6 | 40,28 |
| | 2,5 | | 15 mm | 30260-5 | 43,62 |
| | 2,5 | | 22 mm | 30265-0 | 56,10 |

Schlueterschiene flexibel Edelstahl

166

| | | | | | |
|-------------------------------------|-----|----|-------|-------------------------|-----------------------|
| Edelstahl stainless steel | 2,5 | 10 | 3 mm | 38000-9 | 38,72 |
| | 2,5 | | 5 mm | 38010-8 | 39,02 |
| | 2,5 | | 6 mm | 38020-7 | 43,58 |
| | 2,5 | | 8 mm | 38030-6 | 44,96 |
| | 2,5 | | 10 mm | 38040-5 | 46,76 |
| | 2,5 | | 13 mm | 38050-4 | 48,22 |
| | 2,5 | | 15 mm | 38060-3 | 57,90 |

Biegegeraet fuer flexible Fliesentrennprofile

bending machine for flexible ceramic tile and separation profiles



| | |
|---------------------------|------------------------|
| Art./ref. | |
| 31050-1 | 629,40 |

9. FLIESENTRENN-, DEHNUNGSFUGEN-, BAU- & T-PROFILE / 9. CERAMIC TILE SEPARATION, EXPANSION GAP, BUILDING + T-PROFILES

Lagerlaengen à 6 m
in stock lengths à 6 m

andere Laengen + Abmessungen auf
Anfrage/ other lengths and dimensions
on demand

**178 Winkelprofil
gleichschenklig**

Aluminium silber eloxiert
angle edge, equal size sides,
aluminium silver anodized

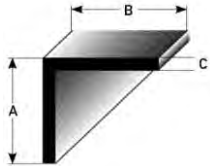

| Aluminium-Bauprofile silber eloxiert (Außenmaße) | | | | |
|--|-----------|-------------------------------|-------------------------|-----------------------|
| aluminium building profiles silver anodized (outside measures) | | | | |
| L / l (m) | VE / unit | AxBxC mm | Art./ref. | €/Stueck/ pcs. |
| 1,0 m | 10 | 10 x 10 x 1 | 45000-9 | 3,34 |
| 1,0 m | | 15 x 15 x 1 | 45002-3 | 4,60 |
| 1,0 m | | 20 x 20 x 1,5 | 45004-7 | 6,34 |
| 1,0 m | | 25 x 25 x 1,5 | 45006-1 | 7,82 |
| 1,0 m | | 30 x 30 x 1,5 | 45008-5 | 9,48 |
| 1,0 m | | 40 x 40 x 1,5 | 45010-8 | 12,70 |
| 2,0 m | 10 | 10 x 10 x 1 | 45016-0 | 6,70 |
| 2,0 m | | 15 x 15 x 1 | 45018-4 | 9,24 |
| 2,0 m | | 20 x 20 x 1,5 | 45020-7 | 12,70 |
| 2,0 m | | 25 x 25 x 1,5 | 45022-1 | 15,66 |
| 2,0 m | | 30 x 30 x 1,5 | 45024-5 | 18,96 |
| 2,0 m | | 40 x 40 x 1,5 | 45026-9 | 25,34 |

**179 Winkelprofil
ungleichschenklig**

Aluminium silber eloxiert
angle edge, different size sides
aluminium silver anodized

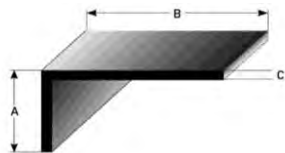

| | | | | |
|-------|-------------------------------|-------------------------------|-----------------------------|-------------------------|
| 1,0 m | 10 | 10 x 15 x 1 | 45032-0 | 3,88 |
| 1,0 m | | 15 x 20 x 1,5 | 45034-4 | 5,54 |
| 1,0 m | | 15 x 25 x 1,5 | 45036-8 | 6,26 |
| 1,0 m | | 20 x 30 x 1,5 | 45038-2 | 7,94 |
| 1,0 m | | 20 x 40 x 1,5 | 45040-5 | 9,48 |
| 2,0 m | | 10 | 10 x 15 x 1 | 45046-7 |
| 2,0 m | 15 x 20 x 1,5 | | 45048-1 | 11,10 |
| 2,0 m | 15 x 25 x 1,5 | | 45050-4 | 12,48 |
| 2,0 m | 20 x 30 x 1,5 | | 45052-8 | 15,82 |
| 2,0 m | 20 x 40 x 1,5 | | 45054-2 | 18,96 |

* inklusive 40 mm Klemmstelle an
einer Seite vom Eloxieren/ including
40 mm clamping point on one side by
anodizing

**2 5 T-Profil 14 mm
fuer Uebergaenge**

T-profile 14 mm for transition

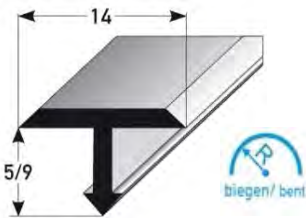

| Fußboden - T - Profile | | | | |
|--------------------------------------|----------------------|------------------------|-------------------------|-----------------------|
| T - profiles | | | | |
| Material+Farbe/material+colour | Höhe/ height | L / l (m) | Art./ref. | €/Stueck/ pcs. |
| Messing blank ,brass mill-finish | 9 mm | 2,5 m | 36380-4 | 27,50 |
| Edelstahl matt stainless steel satin | 9 mm | 2,5 m | 36420-7 | 33,08 |
| Aluminium blank,alu mill-finish | 5 mm | 2,5 m | 36390-3 | 8,32 |
| Alu silber ,alu silver | 5 mm | 2,5 m | 46630-7 | 12,84 |
| Alu gold , alu gold | 5 mm | 2,5 m | 46632-1 | 14,76 |
| Alu bronze hell,alu bonze light | 5 mm | 2,5 m* | 46634-5 | 17,88 |
| Alu bronze dunkel ,alu bonze dark | 5 mm | 2,5 m* | 46636-9 | 17,88 |

**2 6 T-Profil 25 mm
fuer Uebergaenge**

T-profile 25 mm for transition

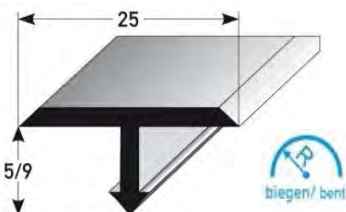

| | | | | |
|---------------------------------------|----------------------|------------------------|-------------------------|-----------------------|
| Messing ziehblank , brass mill-finish | 9 mm | 2,5 m | 36400-9 | 79,96 |
| Edelstahl matt stainless steel satin | 9 mm | 2,5 m | 36430-6 | 44,24 |
| Aluminium blank,alu mill-finish | 5 mm | 2,5 m | 36410-8 | 17,80 |
| Alu silber ,alu silver | 5 mm | 2,5 m | 46640-6 | 22,76 |
| Alu gold , alu gold | 5 mm | 2,5 m | 46642-0 | 25,66 |
| Alu bronze hell,alu bonze light | 5 mm | 2,5 m* | 46644-4 | 29,06 |
| Alu bronze dunkel ,alu bonze dark | 5 mm | 2,5 m* | 46646-8 | 29,06 |



Profil biegen - auf Anfrage/ bent profile - on reqUest

483 Festigungsduebel fuer T-Profile

fixing dowel for T-profiles

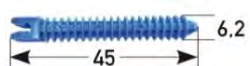

| Abmaß/dimension | Stk./Verpack. pcs./pack | Art./ref. | €/Btl./bag |
|-----------------|--------------------------------|-------------------------|-----------------------|
| 45 x 6,2 mm | 10 Stueck/Pack | 70988-6 | 17,84 |

11. REPARATURWINKEL & PVC-PROFILE/ 11. REPAIR ANGLES + PVC-PROFILES

Schrauben + Dübel
siehe Abschnitt 12!
screws + dowels, see section 12!

| Reparaturwinkel Edelstahl für Treppensanierung | | | | |
|---|-----------|-----------|--------------------|---|
| repair angle steel stainless steel for staircase renovation | | | | |
| Material/material | Art./ref. | L / l (m) | Stk./VE / pcs/unit | € |

EDELSTAHL-Rep.win. **B20** Beton

336

stainless steel repair angle
B20 for concrete stairs
mat smoothed, grain
size 180

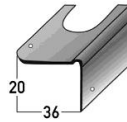

| | | | | | |
|---------------------------|--|-----------------------|----------------------|--------------------|-----------------------|
| 20 mm Nase, 20 mm nose | ohne Befestigungszubehör without fixing accessories | 973-3 | 1 | 25 | 18,16 |
| 20 mm Nase 20 mm nose | ohne Befestigungszubehör without fixing accessories | 982-1 | 1,25 | | 22,48 |
| 20mm Nase 20 mm nose | ohne Befestigungszubehör without fixing accessories | 975-1 | 2 | | 34,04 |

Extra Befestigungszubehör siehe
Abschnitt 12! / Extra fixing accessories,
see section 12!

| Reparaturwinkel Stahl verzinkt für Treppensanierung | | | | |
|--|-----------|-----------|-----------|---|
| repair angle steel galvanized for staircase renovation | | | | |
| Material/material | Art./ref. | L / l (m) | Stk./VE / | € |

Reparaturwinkel **H15** fuer Holztrepfen

243

repair angle H15
for wooden stairs

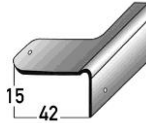

| | | | | | |
|---------------------------|--|-----------------------|----------------------|--------------------|-------------------------|
| 15 mm Nase, 15 mm nose | inkl. Ringnägel incl. ruffled nails | 942-9 | 1,00 | 25 | 6,04 € |
| 15mm Nase, 15 mm nose | inkl. Ringnägel incl. ruffled nails | 943-6 | 2,00 | | 12,16 € |
| 15 mm Nase, 15 mm nose | ohne Befestigungszubehör without fixing accessories | 950-4 | 1,00 | 25 | 5,74 € |
| 15mm Nase, 15 mm nose | ohne Befestigungszubehör without fixing accessories | 951-1 | 2,00 | | 11,54 € |

Reparaturwinkel **H20** fuer Holztrepfen

119

repair angle H20
for wooden stairs

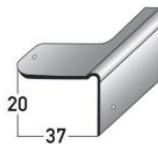

| | | | | | |
|---------------------------|--|-----------------------|----------------------|--------------------|-------------------------|
| 20 mm Nase, 20 mm nose | inkl. Ringnägel incl. ruffled nails | 910-8 | 1,00 | 25 | 6,04 € |
| 20 mm Nase, 20 mm nose | inkl. Ringnägel incl. ruffled nails | 983-0 | 1,25 | | 7,94 € |
| 20 mm Nase, 20 mm nose | inkl. Ringnägel incl. ruffled nails | 915-3 | 2,00 | | 12,16 € |
| 20 mm Nase, 20 mm nose | ohne Befestigungszubehör without fixing accessories | 955-9 | 1,00 | 25 | 5,74 € |
| 20 mm Nase, 20 mm nose | ohne Befestigungszubehör without fixing accessories | 984-9 | 1,25 | | 7,48 € |
| 20 mm Nase, 20 mm nose | ohne Befestigungszubehör without fixing accessories | 957-3 | 2,00 | | 11,54 € |

Reparaturwinkel **H38** fuer Holztrepfen

242

repair angle H38
for wooden stairs



| | | | | | |
|---------------------------|--|-----------------------|----------------------|--------------------|-------------------------|
| 38 mm Nase, 38 mm nose | inkl. Ringnägel incl. ruffled nails | 920-7 | 1,00 | 25 | 7,72 € |
| 38mm Nase, 38 mm nose | inkl. Ringnägel incl. ruffled nails | 925-2 | 2,00 | | 15,54 € |
| 38 mm Nase, 38 mm nose | ohne Befestigungszubehör without fixing accessories | 960-3 | 1,00 | 25 | 7,02 € |
| 38mm Nase, 38 mm nose | ohne Befestigungszubehör without fixing accessories | 961-0 | 2,00 | | 13,94 € |

11. REPARATURWINKEL & PVC-PROFILE/ 11. REPAIR ANGLES + PVC-PROFILES

Schrauben + Dübel
siehe Abschnitt 12!
screws + dowels, see section 12!

| Reparaturwinkel Edelstahl für Treppenanierung | | | | |
|---|-----------|-----------|---------|---|
| repair angle steel stainless steel for staircase renovation | | | | |
| Material/material | Art./ref. | L / l (m) | Stk./VE | € |

Reparaturwinkel **B15** fuer Betontreppen 244

repair angle B15
for concrete stairs

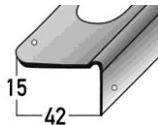

| | | | | | |
|---------------------------|--|-----------------------|------|----|-------------------------|
| 15 mm Nase, 15 mm nose | inkl. Schrauben + Dübel incl. screws + dowels | 945-0 | 1,00 | 25 | 8,14 € |
| 15mm Nase, 15 mm nose | inkl. Schrauben + Dübel incl. screws + dowels | 946-7 | 2,00 | | 15,96 € |
| 15 mm Nase, 15 mm nose | ohne Befestigungszubehör without fixing accessories | 965-8 | 1,00 | 25 | 7,22 € |
| 15mm Nase, 15 mm nose | ohne Befestigungszubehör without fixing accessories | 966-5 | 2,00 | | 14,50 € |

Reparaturwinkel **B20** fuer Betontreppen 120

repair angle B20
for concrete stairs

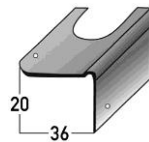

| | | | | | |
|---------------------------|--|-----------------------|------|----|-------------------------|
| 20 mm Nase, 20 mm nose | inkl. Schrauben + Dübel incl. screws + dowels | 930-6 | 1,00 | 25 | 8,14 € |
| 20 mm Nase, 20 mm nose | inkl. Schrauben + Dübel incl. screws + dowels | 985-8 | 1,25 | | 10,56 € |
| 20 mm Nase, 20 mm nose | inkl. Schrauben + Dübel incl. screws + dowels | 935-1 | 2,00 | | 15,96 € |
| 20 mm Nase, 20 mm nose | ohne Befestigungszubehör without fixing accessories | 970-2 | 1,00 | 25 | 7,22 € |
| 20 mm Nase, 20 mm nose | ohne Befestigungszubehör without fixing accessories | 986-7 | 1,25 | | 9,44 € |
| 20 mm Nase, 20 mm nose | ohne Befestigungszubehör without fixing accessories | 972-6 | 2,00 | | 14,50 € |

RUND-Reparaturwinkel **B25x40, R 7,5** fuer DEBOLON-TK 3 432

round repair angle
B25x40 R 7,5
for Debolon-TK 3

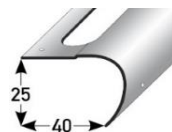

| | | | | | |
|---------------------------|--|-----------------------|------|----|-------------------------|
| 25 mm Nase, 25 mm nose | inkl. Schrauben + Dübel incl. screws + dowels | 979-7 | 1,00 | 25 | 13,06 € |
| 25 mm Nase, 25 mm nose | inkl. Schrauben + Dübel incl. screws + dowels | 987-6 | 1,25 | | 17,86 € |
| 25 mm Nase, 25 mm nose | inkl. Schrauben + Dübel incl. screws + dowels | 981-2 | 2,00 | | 25,90 € |
| 25 mm Nase, 25 mm nose | ohne Befestigungszubehör without fixing accessories | 976-0 | 1 | 25 | 12,2 |
| 25 mm Nase, 25 mm nose | ohne Befestigungszubehör without fixing accessories | 988-5 | 1,25 | | 15,84 |
| 25 mm Nase, 25 mm nose | ohne Befestigungszubehör without fixing accessories | 978-8 | 2 | | 24,44 |



Ihr Bodenausstatter

überreicht durch: